

Serie MK-MKS

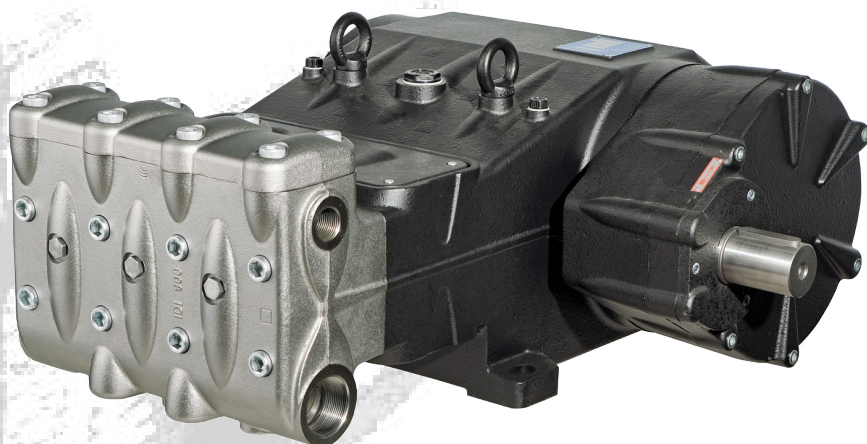

MKR-MKSR- MKC-MKSC



MK40 – MK45 – MK50

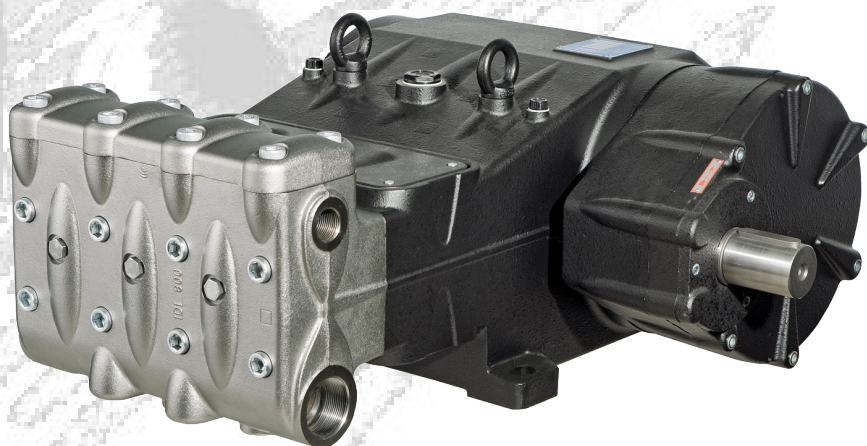

MK55 – MK60 – MK65



Manuale di riparazione
Repair Manual
Manuel de réparation
Reparaturanleitung
Manual de reparación
Manual de reparação

Sommario

1	INTRODUZIONE.....	3
1.1	DESCRIZIONE SIMBOLI	3
2	NORME DI RIPARAZIONE	3
2.1	RIPARAZIONE DELLA PARTE MECCANICA	3
2.1.1	<i>Smontaggio della parte meccanica</i>	3
2.1.2	<i>Montaggio parte meccanica</i>	10
2.1.3	<i>Classi di maggiorazione previste</i>	17
2.2	RIPARAZIONE DELLA PARTE IDRAULICA	17
2.2.1	<i>Smontaggio della testata - gruppi valvole</i>	17
2.2.2	<i>Montaggio della testata - gruppi valvole</i>	18
2.2.3	<i>Smontaggio del gruppo pistone - supporti - tenute</i>	23
2.2.4	<i>Montaggio del gruppo pistone - supporti - tenute</i>	25
2.2.5	<i>Recupero testate</i>	29
3	TARATURE SERRAGGIO VITI	30
4	ATTREZZI PER LA RIPARAZIONE	31
5	SOSTITUZIONE DELLA BOCCOLA DI PIEDE BIELLA	32
6	VERSIONI SPECIALI	33
6.1	SMONTAGGIO DEL GRUPPO PISTONE - SUPPORTI - TENUTE	33
6.2	MONTAGGIO DEL GRUPPO PISTONE - SUPPORTI - TENUTE.....	35

1 INTRODUZIONE

Questo manuale descrive le istruzioni per la riparazione delle pompe famiglia MK e deve essere attentamente letto e compreso prima di effettuare ed eseguire qualsiasi intervento sulla pompa.

Dal corretto uso e dalle adeguate manutenzione dipende il regolare funzionamento e durata della pompa.

Interpump Group declina ogni responsabilità per danni causati da negligenza e mancata osservazione delle norme descritte in questo manuale.

1.1 DESCRIZIONE SIMBOLI

Leggere attentamente quanto riportato in questo manuale prima di ogni operazione.



Segnale di Avvertenza



Leggere attentamente quanto riportato in questo manuale prima di ogni operazione.



Segnale di Pericolo

Munirsi di occhiali protettivi.



Segnale di Pericolo

Munirsi di guanti protettivi prima di ogni operazione.

2 NORME DI RIPARAZIONE



2.1 RIPARAZIONE DELLA PARTE MECCANICA

Le operazioni di riparazione della parte meccanica devono essere eseguite dopo aver rimosso l'olio dal carter.

Per togliere l'olio occorre rimuovere il tappo di carico olio pos. ①, Fig. 1 e successivamente il tappo di scarico pos. ②, Fig. 1.

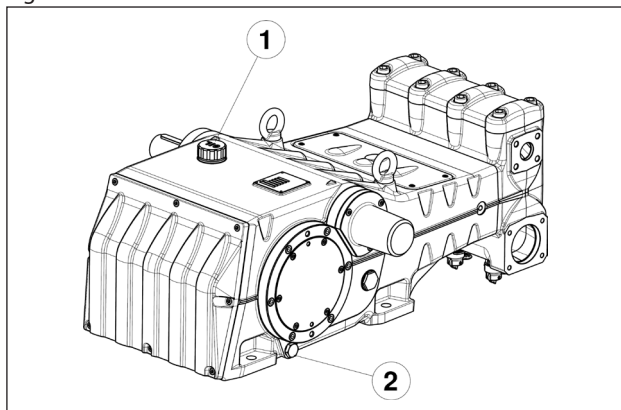

Fig. 1



L'olio esausto deve essere messo in un apposito recipiente e smaltito negli appositi centri. Non deve essere assolutamente disperso nell'ambiente.

2.1.1 Smontaggio della parte meccanica

La corretta sequenza è la seguente:

Svuotare completamente la pompa dall'olio, quindi rimuovere la linguetta dall'albero (pos. ①, Fig. 2).



Fig. 2

Svitare le viti di fissaggio flangia riduttore (pos. ①, Fig. 3) e sfilare la flangia dall'albero.

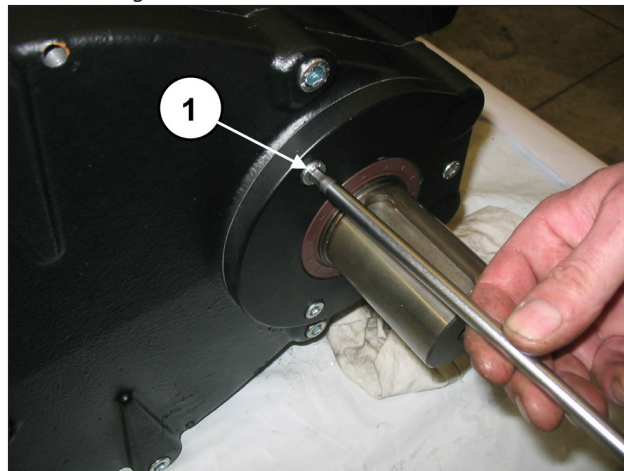

Fig. 3

Dalla parte opposta svitare le viti di fissaggio coperchio cuscinetto (pos. ①, Fig. 4) e rimuoverlo.

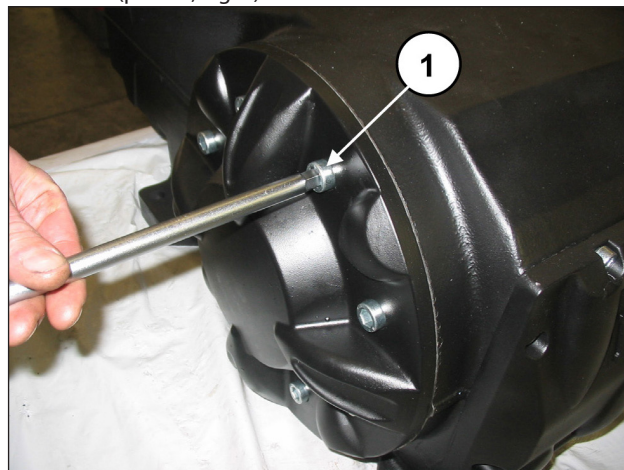

Fig. 4

Provvedere ora allo smontaggio del coperchio carter svitando le relative viti (pos. ①, Fig. 5).

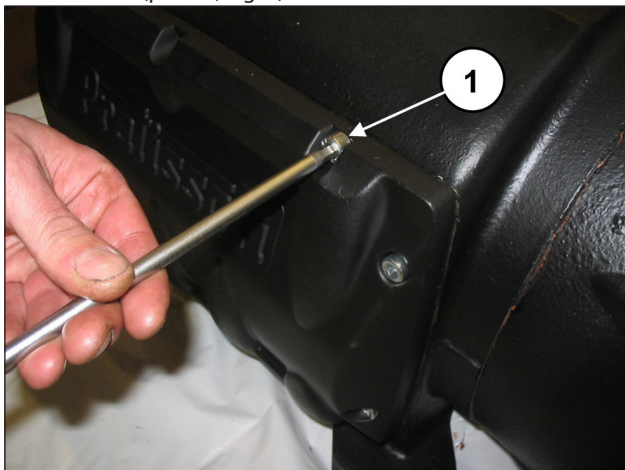

Fig. 5

Svitare le viti di fissaggio coperchio riduttore (pos. ①, Fig. 6).

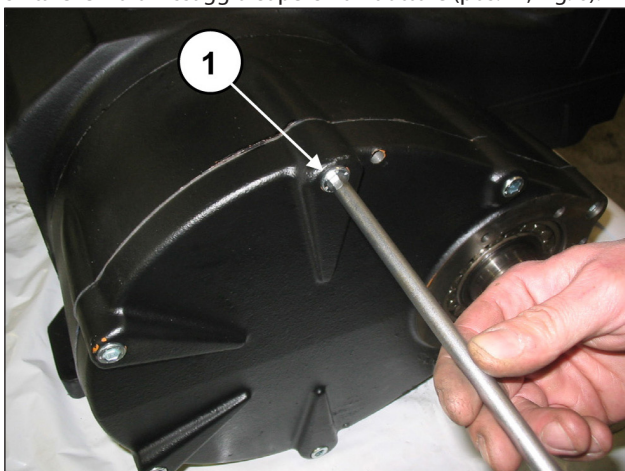

Fig. 6

Posizionare n. 3 grani o viti filettate M8 (pos. ①, Fig. 7) con la funzione di estrattori negli appositi fori e due viti M10 sufficientemente lunghe con la funzione di sostegno coperchio (pos. ②, Fig. 7).

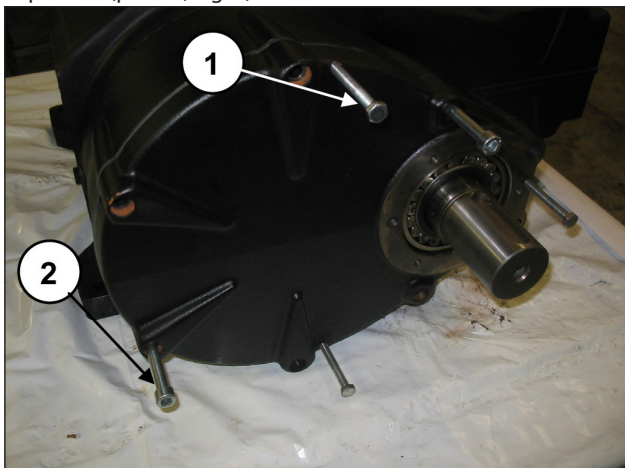

Fig. 7

Avvitare i 3 grani filettati (pos. ①, Fig. 8) con la funzione di estrattori e contemporaneamente, utilizzando l'apposito attrezzo (cod. 27516700), battere sullo stesso in modo che il cuscinetto rimanga sul pignone durante l'estrazione del coperchio (pos. ①, Fig. 9).

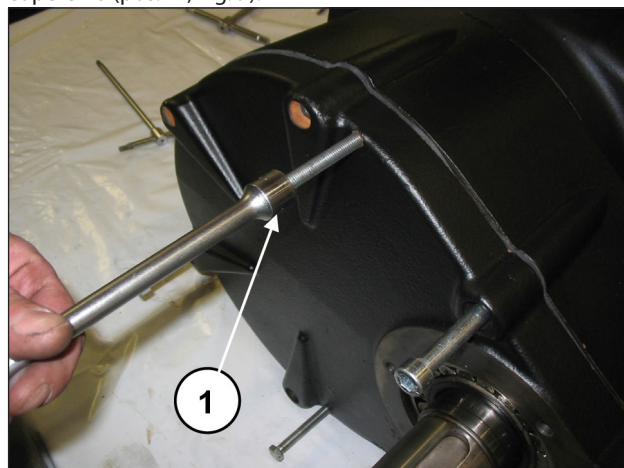

Fig. 8

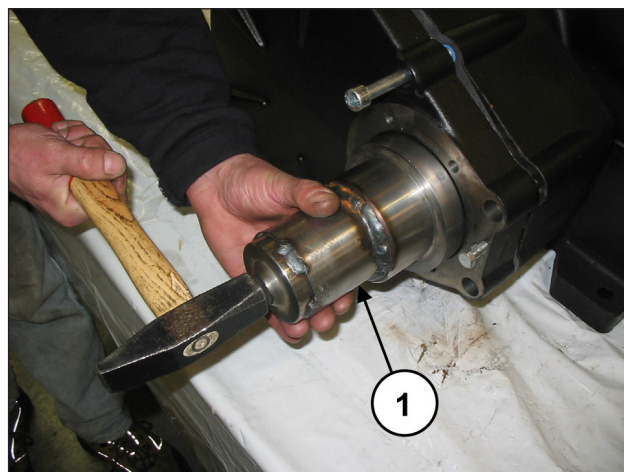

Fig. 9

Ad operazione terminata rimuovere il coperchio riduttore e successivamente sfilare il cuscinetto dal pignone. Svitare le viti che fissano il fermo corona (pos. ①, Fig. 10) e rimuoverlo (pos. ①, Fig. 11).

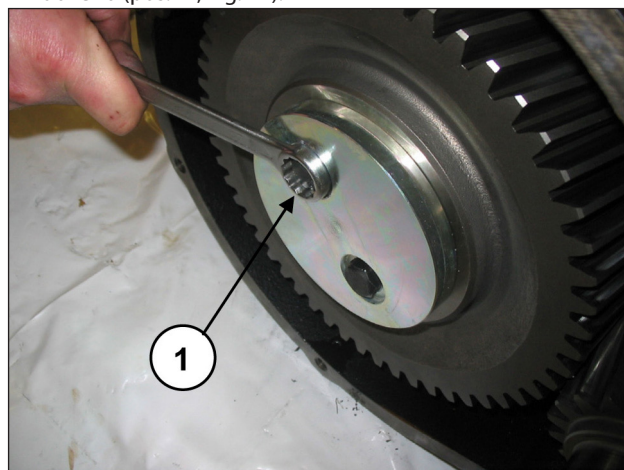

Fig. 10

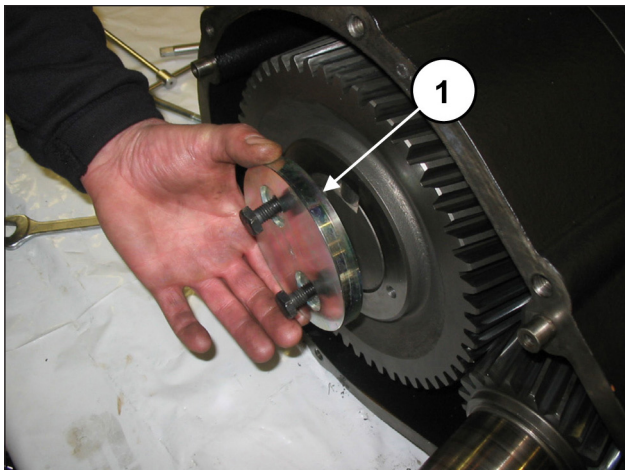

Fig. 11

Togliere la corona (pos. ①, Fig. 12). Qualora fosse necessario è possibile utilizzare un estrattore a massa battente da applicare ai 2 fori M8 (pos. ②, Fig. 12).

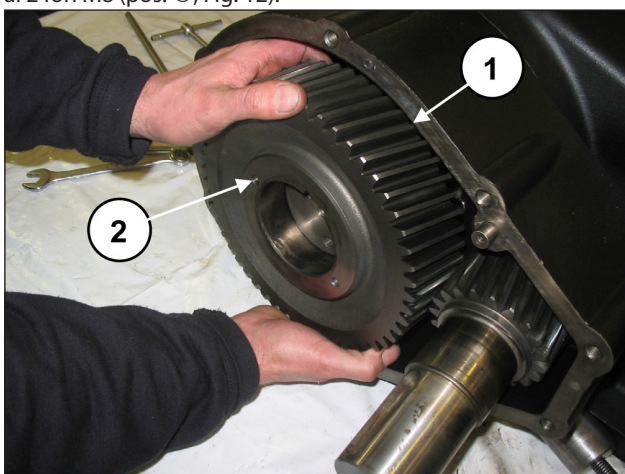

Fig. 12

Togliere la linguetta dall'albero (pos. ①, Fig. 13).

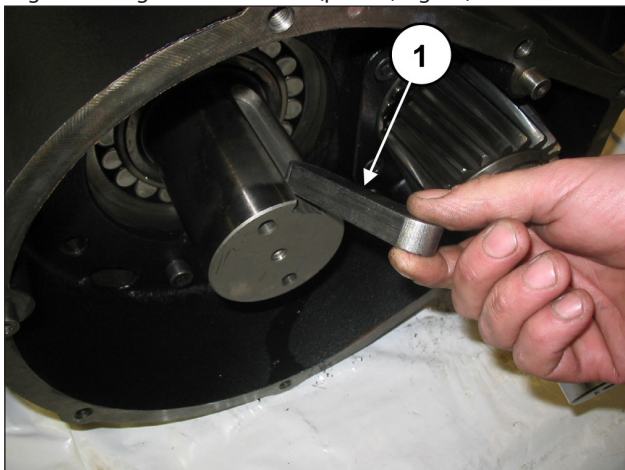

Fig. 13

Togliere il pignone utilizzando un estrattore a massa battente da applicare al foro M14 (pos. ①, Fig. 14).

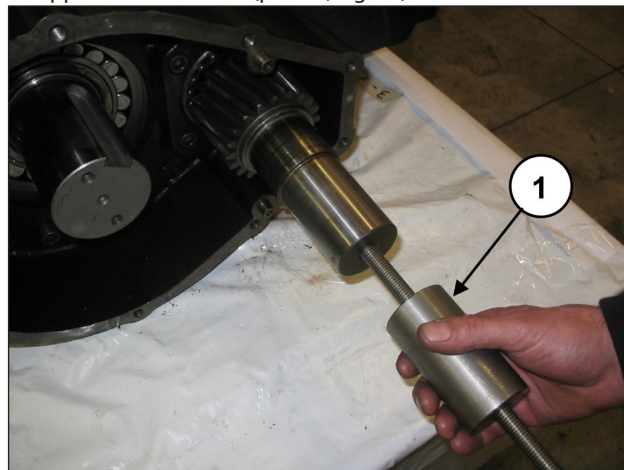

Fig. 14

Sollevere la linguetta della rosetta di sicurezza (pos. ①, Fig. 15).

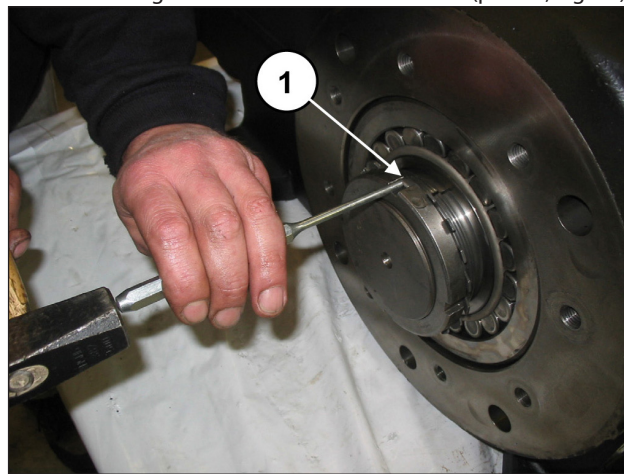

Fig. 15

Inserire uno spessore sotto la biella per bloccare la rotazione dell'albero (pos. ①, Fig. 16).

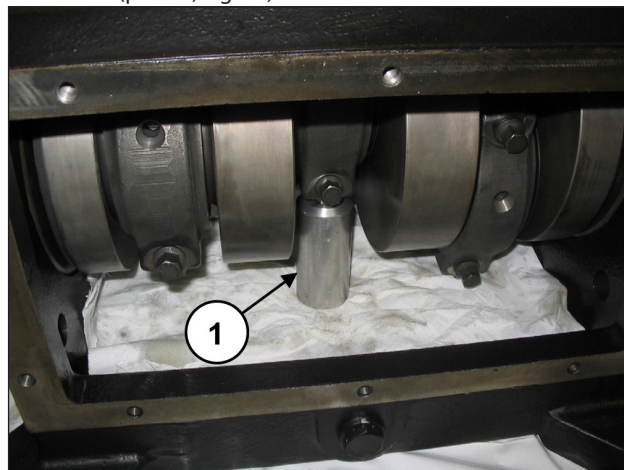

Fig. 16

Utilizzando una opportuna chiave provvedere a svitare la ghiera di bloccaggio (pos. ①, Fig. 17) poi rimuovere la ghiera e la rosetta di sicurezza (pos. ①, Fig. 18).

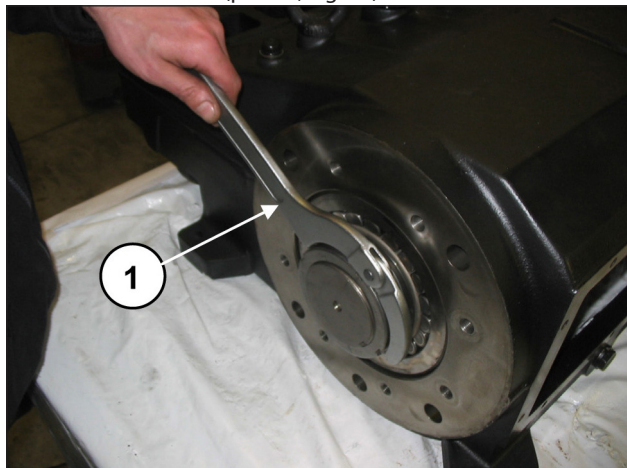

Fig. 17

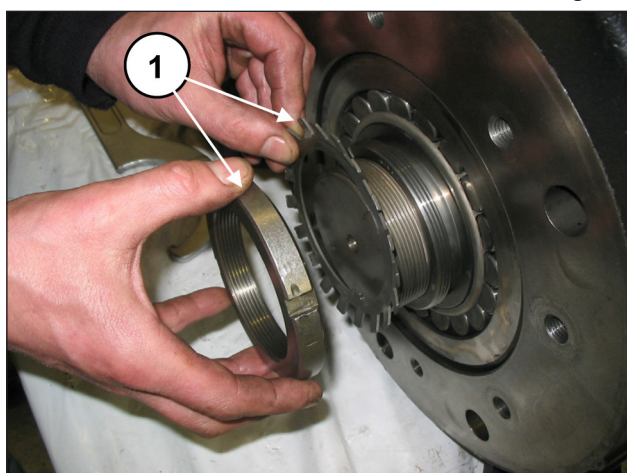

Fig. 18

Avvitare una ghiera tipo SKF KM19 sulla bussola di pressione (pos. ①, Fig. 19), quindi utilizzando una opportuna chiave provvedere ad allentare la bussola (pos. ①, Fig. 20).

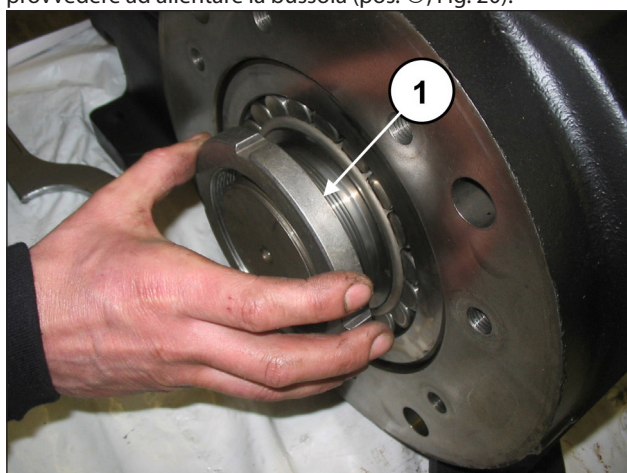

Fig. 19

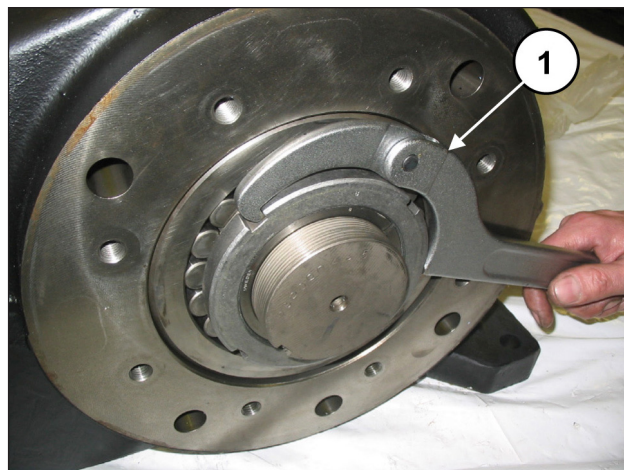

Fig. 20

Sul lato opposto svitare le viti di fissaggio della scatola riduttore (pos. ①, Fig. 21), quindi rimuoverla (pos. ①, Fig. 22).

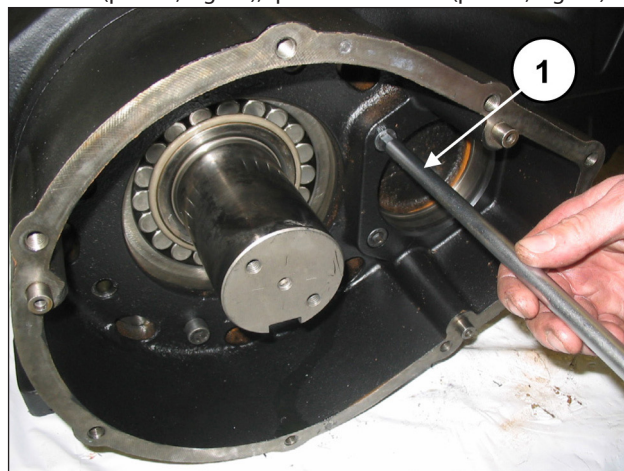

Fig. 21

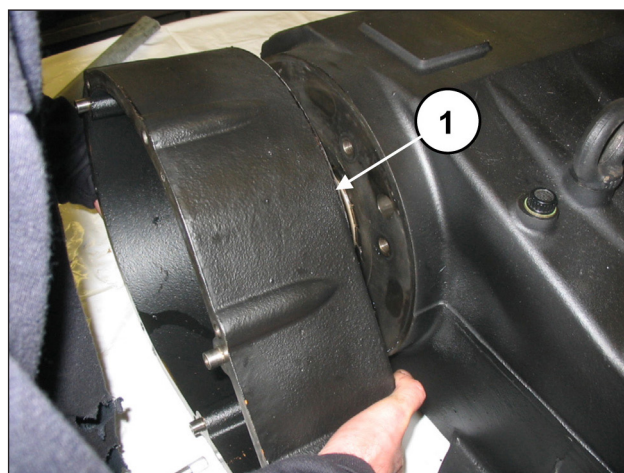

Fig. 22

Svitare le viti di biella (pos. ①, Fig. 23).

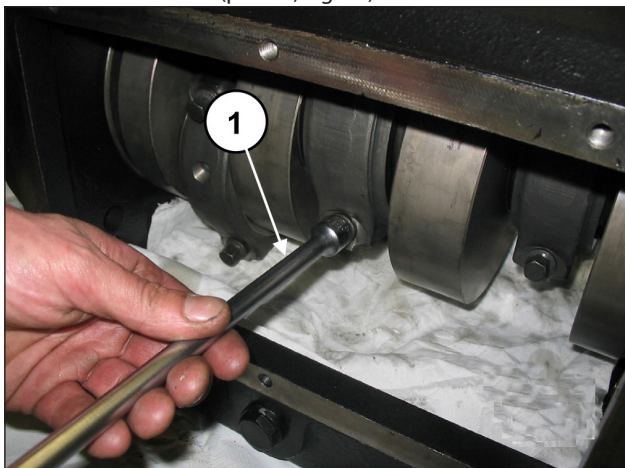

Fig. 23

Smontare i cappelli di biella con i semicuscinetti avendo particolare cura, durante lo smontaggio, dell'ordine in cui vengono smontati.



I cappelli di biella e le relative semibielle devono essere rimontati esattamente nello stesso ordine e accoppiamento in cui sono stati smontati.

Per evitare possibili errori cappelli e semibielle sono stati numerati su un lato (pos. ①, Fig. 24).

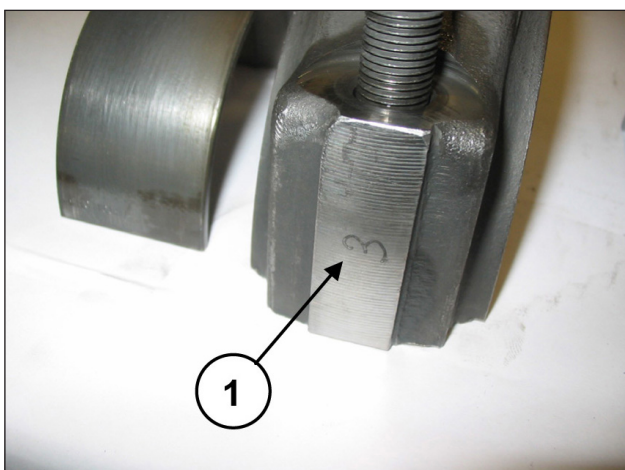

Fig. 24

Fare avanzare le semibielle nella direzione della parte idraulica per permettere la fuoriuscita dell'albero. Per facilitare l'operazione utilizzare l'apposito attrezzo (cod. 27566200), (pos. ①, Fig. 25).

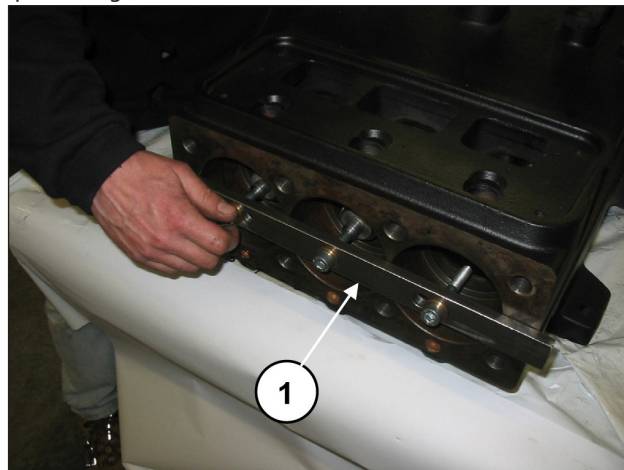

Fig. 25

Togliere la bussola di pressione (pos. ①, Fig. 26).

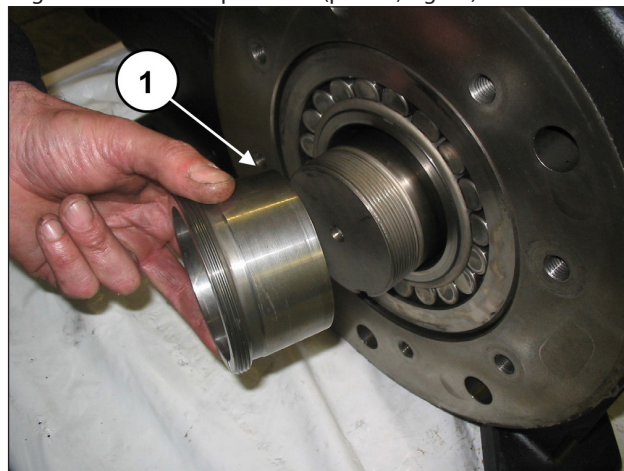

Fig. 26

Sfilare i tre semicuscinetti superiori delle semibielle (pos. ①, Fig. 27).

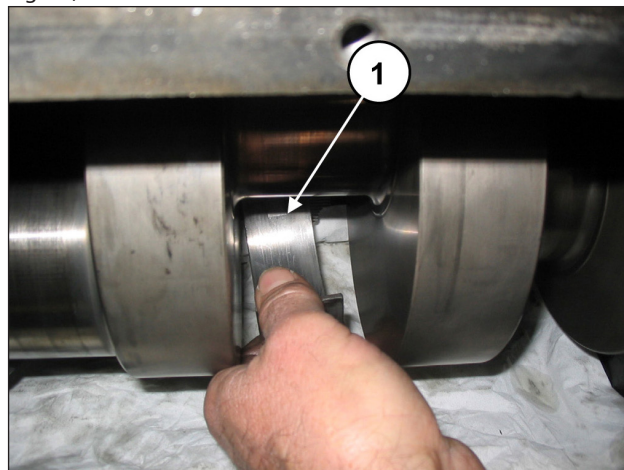

Fig. 27

Sfilare l'albero a gomiti con l'ausilio di una massa battente dal lato PTO (pos. ①, Fig. 28).

Estrarre albero e cuscinetto (pos. ①, Fig. 29).

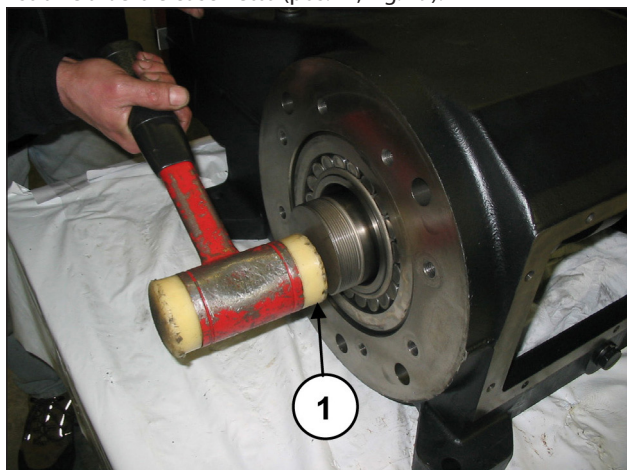

Fig. 28

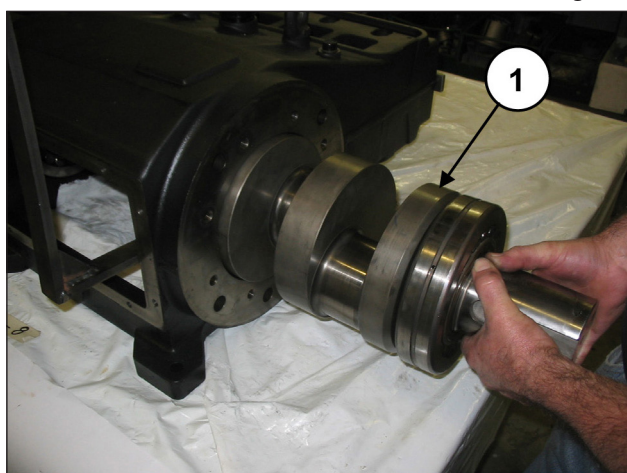

Fig. 29

Dalla parte opposta estrarre il cuscinetto (pos. ①, Fig. 30).

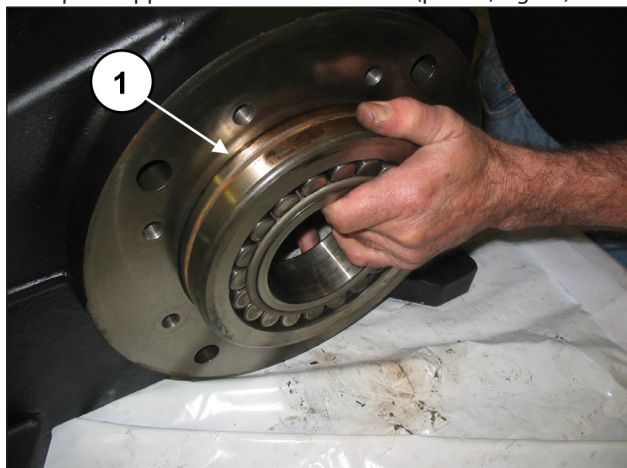

Fig. 30

Nell'eventualità fosse necessario sostituire una o più bielle o guide pistone occorre operare nel seguente modo:

Procedere a svitare le viti dell'attrezzo cod. 27566200 per sbloccare le bielle (pos. ①, Fig. 31) e successivamente estrarre i gruppi biella-guida pistone dall'apertura posteriore del carter (pos. ①, Fig. 32).

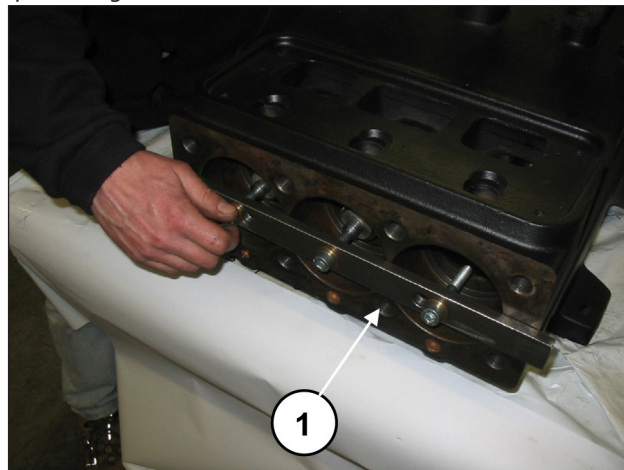

Fig. 31

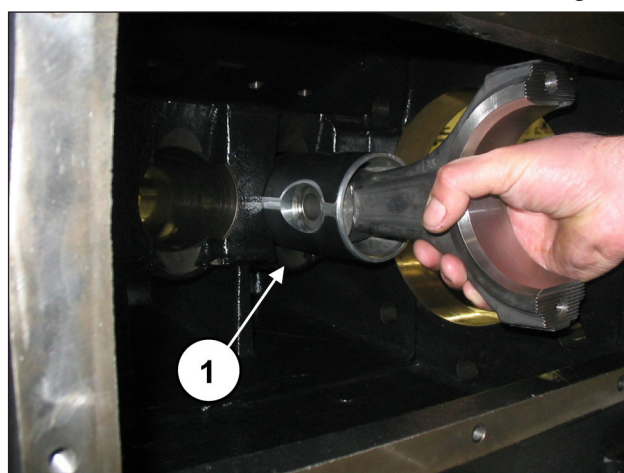

Fig. 32

Accoppiare le semibielle ai cappelli precedentemente smontati facendo riferimento alla numerazione (pos. ①, Fig. 33).

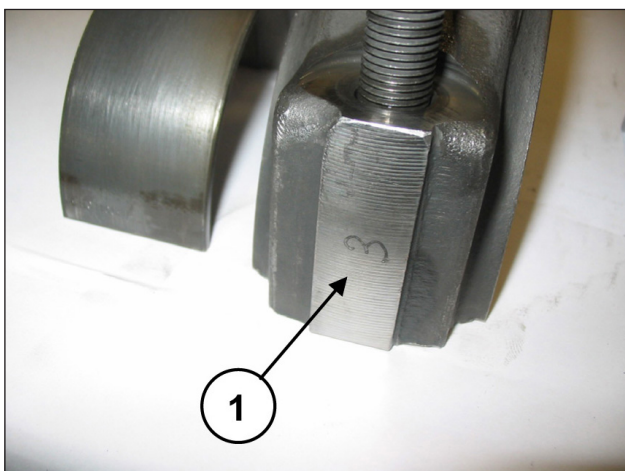

Fig. 33

Rimuovere i due anelli seeger di bloccaggio spinotto utilizzando un apposito attrezzo (pos. ①, Fig. 34).

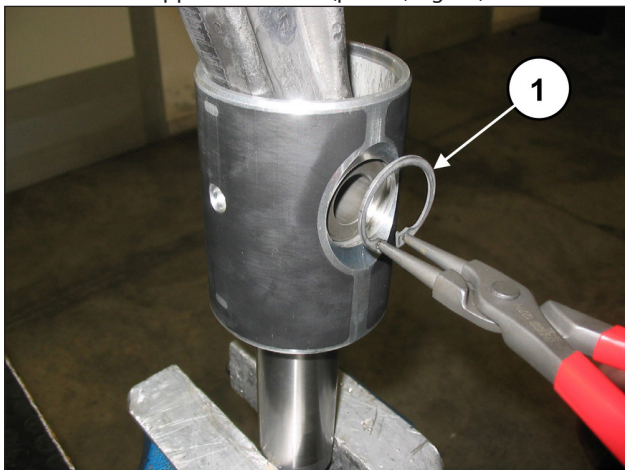

Fig. 34

Sfilare lo spinotto (pos. ①, Fig. 35) e provvedere all'estrazione della biella (pos. ①, Fig. 36).



Fig. 35

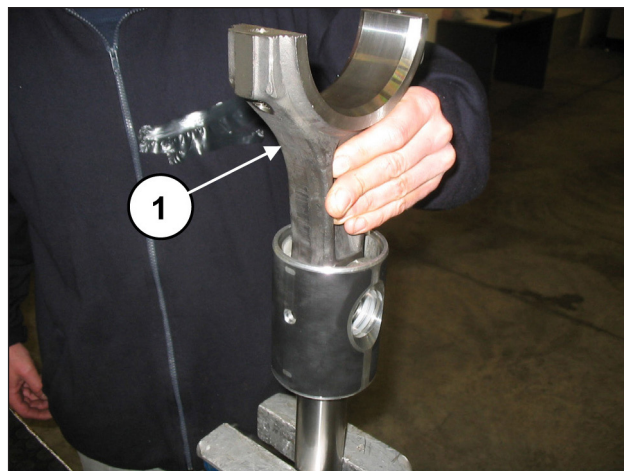

Fig. 36

Per separare lo stelo dal guida pistone occorre svitare le viti a testa cilindrica M6 mediante apposita chiave (pos. ①, Fig. 37).

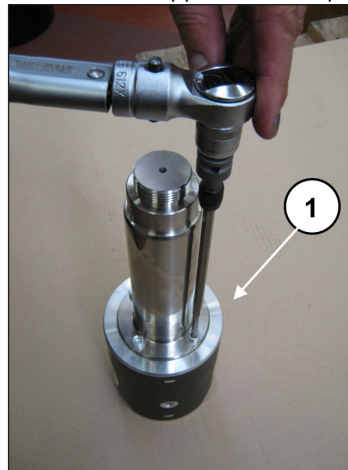

Fig. 37

2.1.2 Montaggio parte meccanica

Procedere al montaggio seguendo il procedimento inverso indicato al par. 2.1.1.

La corretta sequenza è la seguente:

Assemblare lo stelo al guida pistone.

Inserire lo stelo guida pistone nell'apposita sede sul guida pistone (pos. ①, Fig. 38) e fissarlo a quest'ultimo mediante le 4 viti a testa cilindrica M6x20 (pos. ①, Fig. 39).



Fig. 38



Fig. 39

Bloccare il guida pistone in morsa con l'ausilio di apposito attrezzo e procedere alla taratura delle viti con chiave dinamometrica (pos. ①, Fig. 40) come indicato nel capitolo 3.

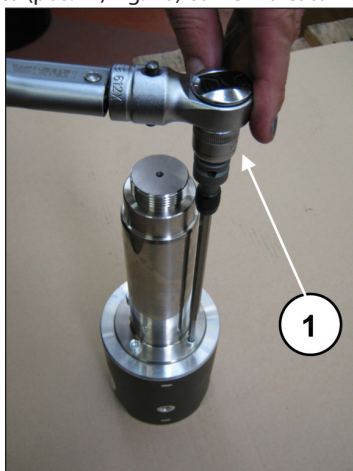

Fig. 40

Inserire la biella nel guida pistone (pos. ①, Fig. 36) e successivamente inserire lo spinotto (pos. ①, Fig. 35). Applicare i due seeger di sbalamento con l'apposito attrezzo (pos. ①, Fig. 34).



Il corretto montaggio è garantito se piede biella, guida pistone e spinotto ruotano liberamente

Separare i cappelli dalle semibielle; il corretto accoppiamento sarà garantito dalla numerazione posta su un lato (pos. ①, Fig. 33).

Dopo aver verificato la perfetta pulizia del carter inserire il gruppo semibiella-guida pistone all'interno delle canne del carter (pos. ①, Fig. 32).



L'inserimento del gruppo semibiella-guida pistone nel carter deve essere fatto orientando le semibielle con la numerazione visibile dall'alto.

Bloccare i tre gruppi utilizzando l'apposito attrezzo cod. 27566200 (pos. ①, Fig. 31).

Premontare il cuscinetto lato PTO sull'albero fino a battuta (pos. ①, Fig. 41) e montare il cuscinetto lato opposto sul carter (pos. ①, Fig. 42).



Il cuscinetto in Fig. 42 ha l'anello interno conico. Verificare che la conicità sia dall'esterno all'interno per permettere il successivo inserimento della bussola.

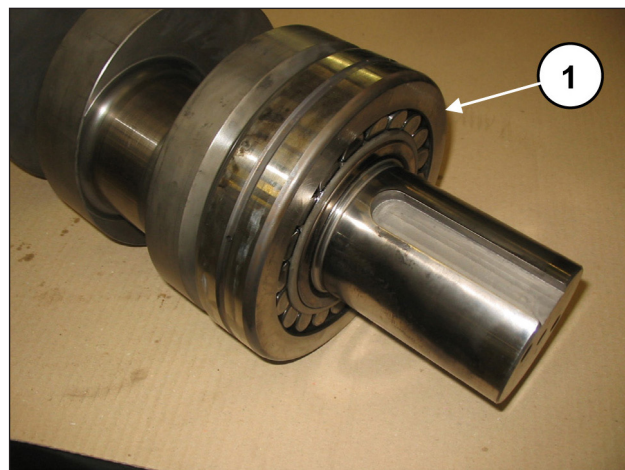

Fig. 41

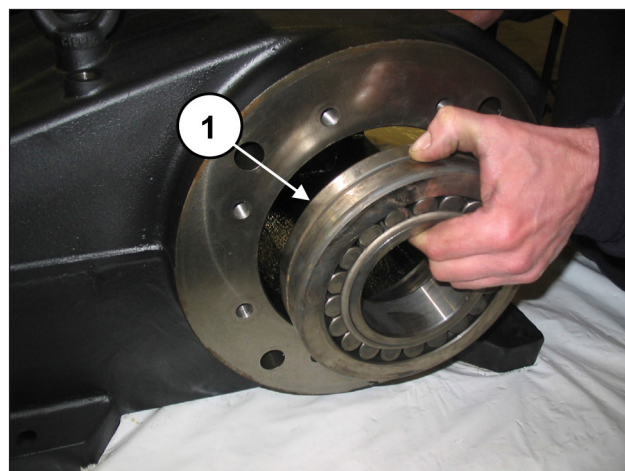

Fig. 42

Inserire l'albero (pos. ①, Fig. 29) fino a che il cuscinetto premontato arrivi ad essere a filo del bordo del carter (pos. ①, Fig. 43).

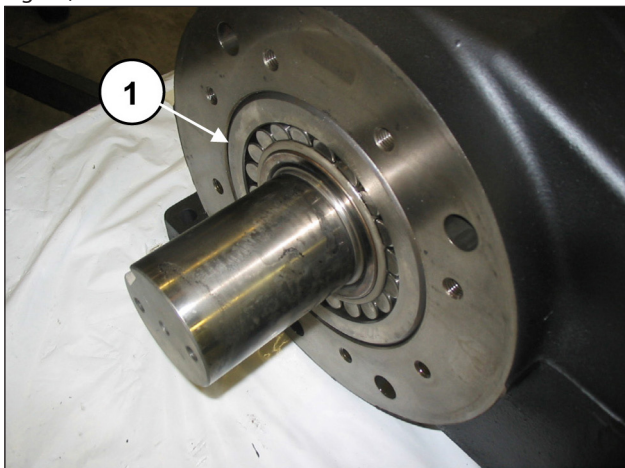

Fig. 43

Inserire manualmente la bussola di pressione per mantenere l'albero allineato (pos. ①, Fig. 44).

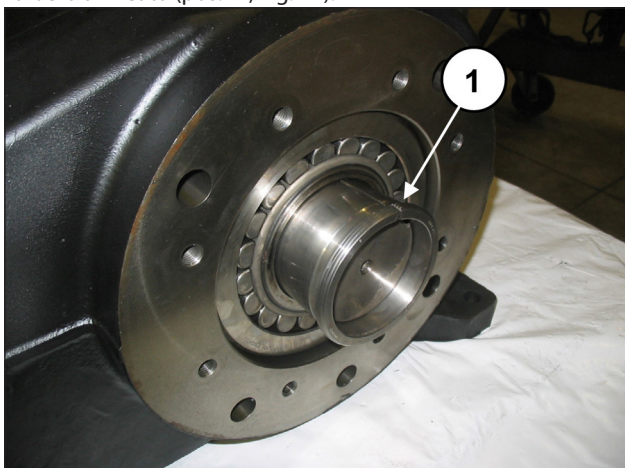

Fig. 44

Montare la scatola riduttore (pos. ①, Fig. 45) e la relativa guarnizione (pos. ②, Fig. 45) utilizzando le 6 viti M12x40 (pos. ①, Fig. 46), le 2 viti M12x50 (pos. ①, Fig. 47) e le rondelle Grower Ø12 (pos. ②, Fig. 46 e Fig. 47).
Tarare le viti con chiave dinamometrica (pos. ①, Fig. 48) come indicato nel capitolo 3.

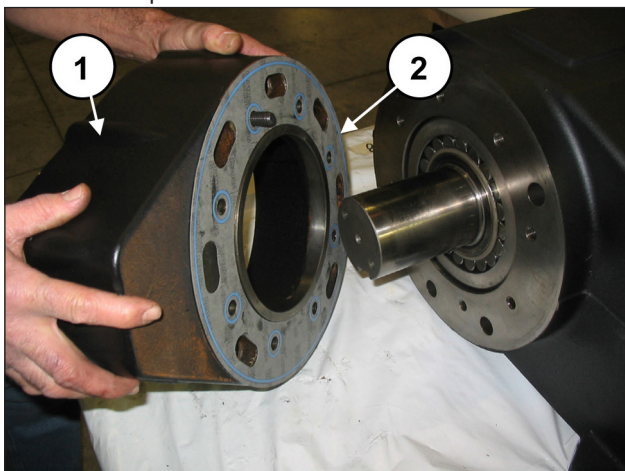

Fig. 45

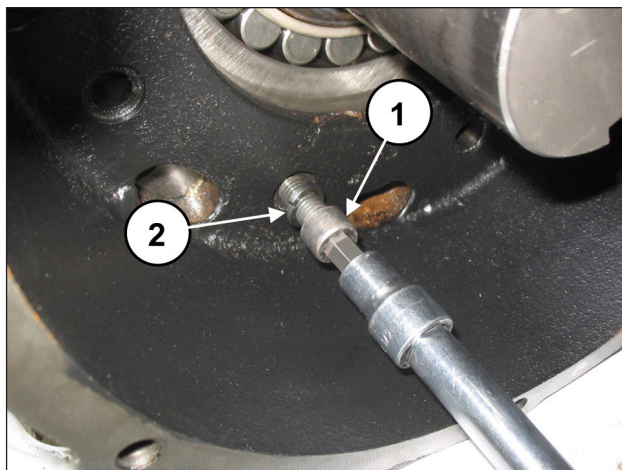

Fig. 46

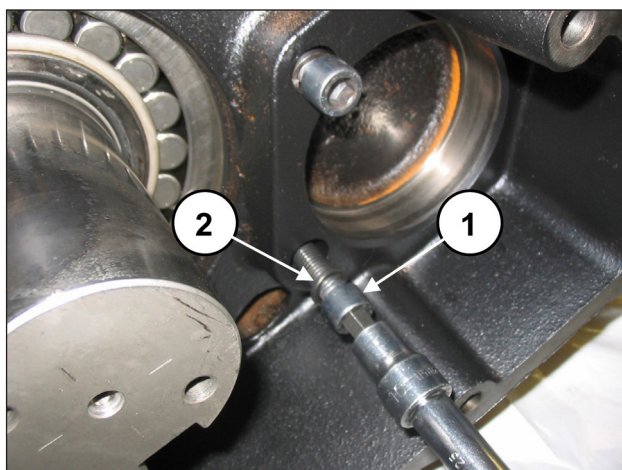

Fig. 47

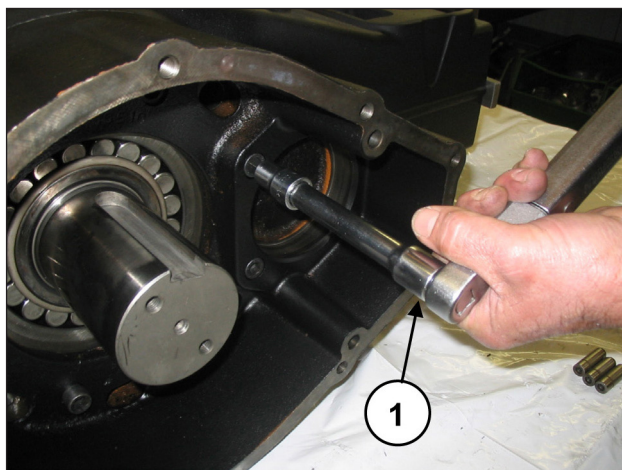

Fig. 48

Inserire completamente la bussola di pressione sull'albero dal lato opposto alla PTO (pos. ①, Fig. 49 e Fig. 50).

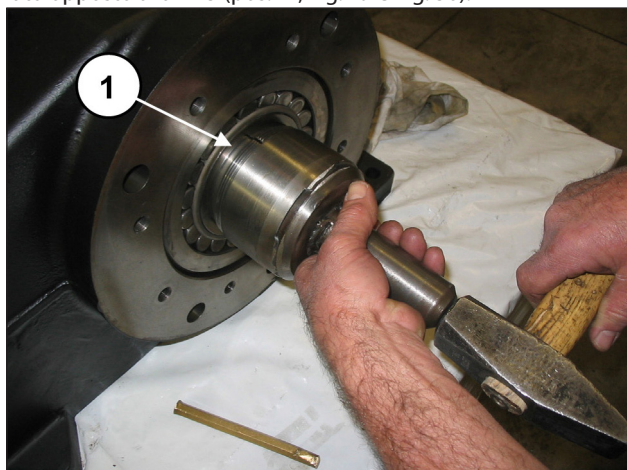

Fig. 49

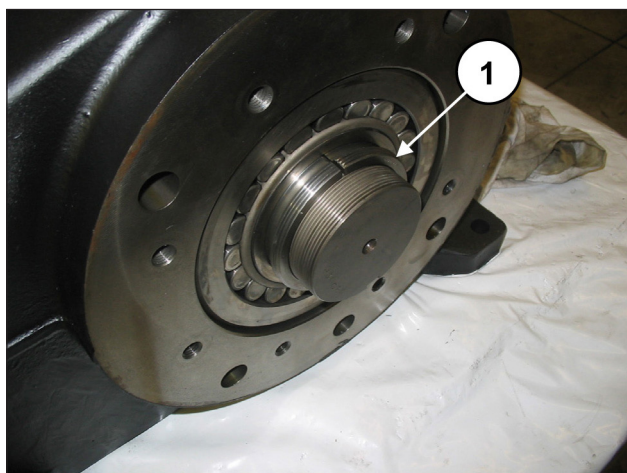

Fig. 50



L'inserimento della bussola di pressione deve essere effettuato a secco (senza oli o lubrificanti).

Inserire la bussola fino a che la superficie esterna (conica) arrivi ad accoppiarsi perfettamente con l'interno del cuscinetto. Durante l'inserimento assicurarsi che il cuscinetto rimanga a contatto con lo spallamento dell'albero. Misurare la quota "X" indicata in Fig. 51.

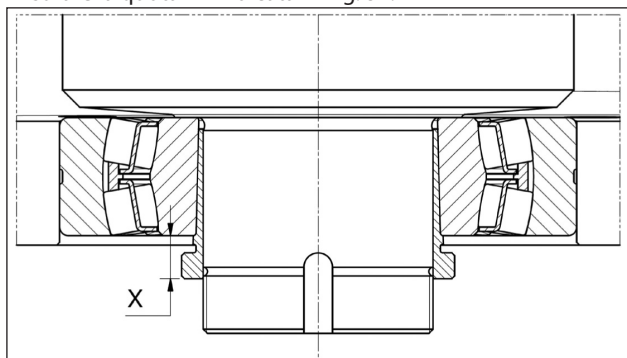

Fig. 51

Avvitare la ghiera di bloccaggio e serrare la bussola fino a determinare una riduzione della quota "X" compresa tra 0.7 e 0.8 mm (Fig. 52).

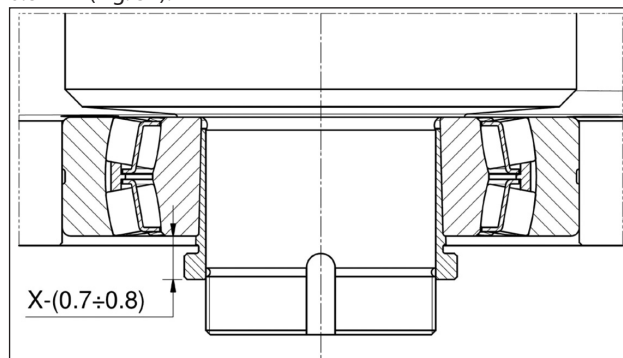

Fig. 52

Svitare la ghiera, inserire la rosetta di sicurezza (pos. ①, Fig. 53) e riavvitare a fondo la ghiera (pos. ①, Fig. 54), dopodiché piegare la linguetta di bloccaggio della rosetta (pos. ①, Fig. 55).

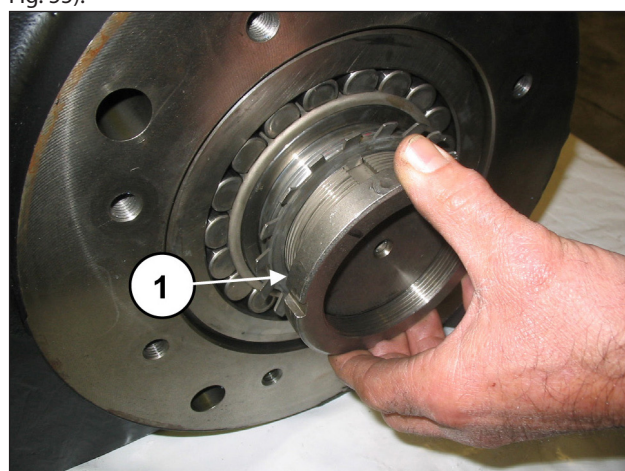

Fig. 53

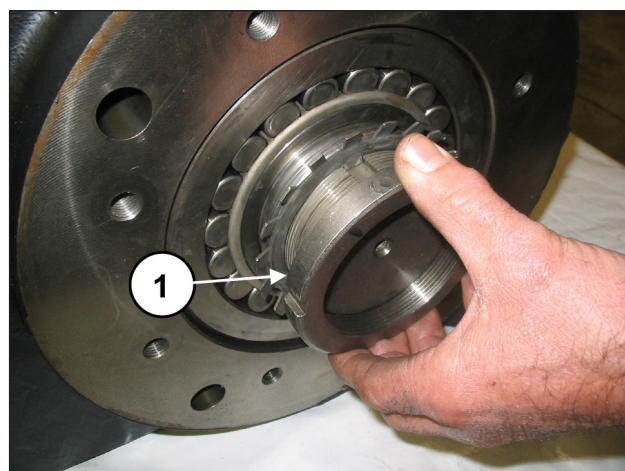

Fig. 54

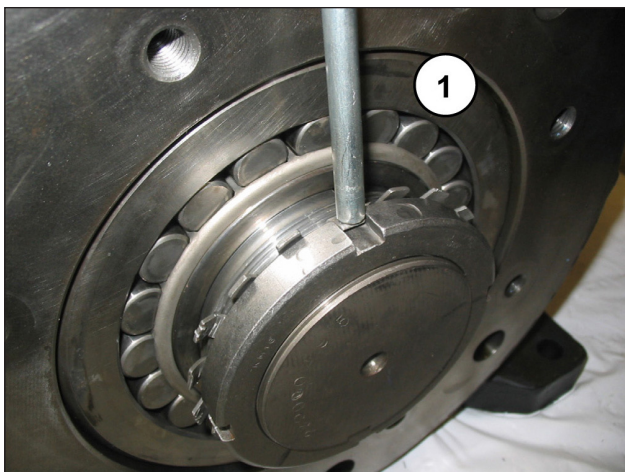

Fig. 55

Rimuovere l'attrezzo per il bloccaggio delle bielle cod. 27566200 (pos. ①, Fig. 31).

Inserire i semicuscinetti superiori tra le bielle e l'albero (pos. ①, Fig. 56).



Per un corretto montaggio dei semicuscinetti assicurarsi che la linguetta di riferimento dei semicuscinetti venga posizionata nell'apposito alloggiamento sulla semibiella (pos. ①, Fig. 57).

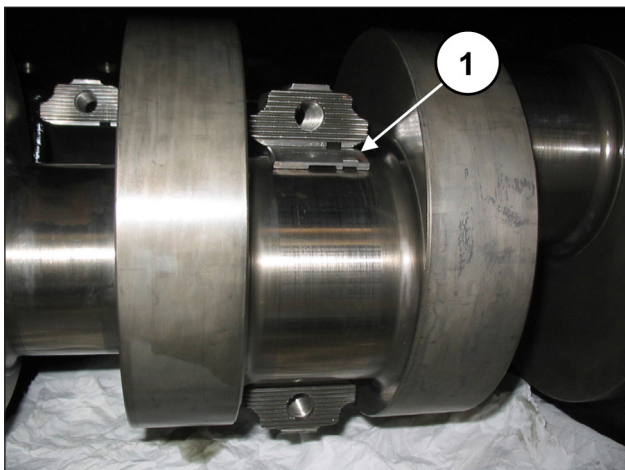

Fig. 56

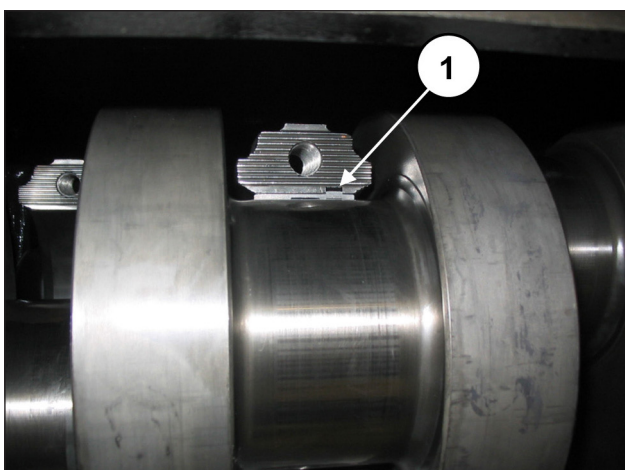

Fig. 57

Applicare i semicuscinetti inferiori ai cappelli (pos. ①, Fig. 58) assicurandosi che la linguetta di riferimento dei semicuscinetti venga posizionata nell'apposito alloggiamento sul cappello (pos. ②, Fig. 58).

Fissare i cappelli alle semibielle mediante le viti M12x1.25x87 (pos. ①, Fig. 59).



Prestare attenzione al corretto senso di montaggio dei cappelli. La numerazione deve essere rivolta verso l'alto.

Tarare le viti con chiave dinamometrica come indicato nel capitolo 3, portando le viti alla coppia di serraggio contemporaneamente.

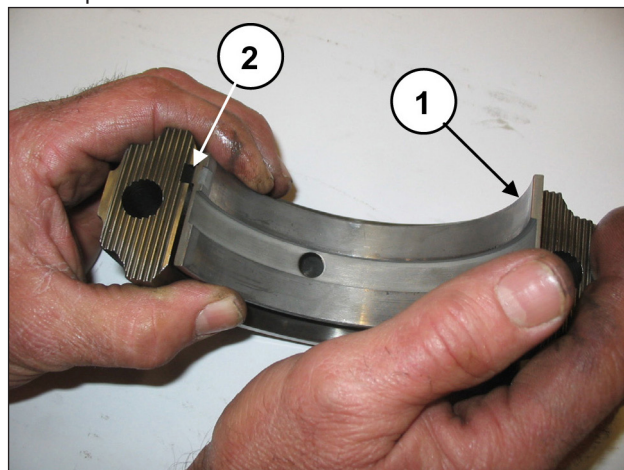

Fig. 58

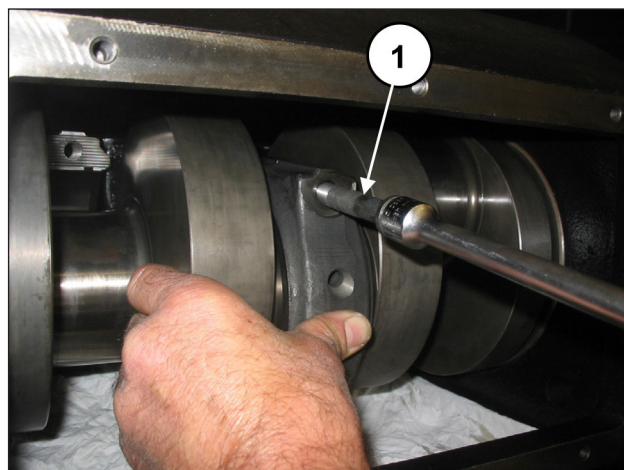

Fig. 59



Ad operazione conclusa verificare che le bielle abbiano gioco assiale in entrambe le direzioni.

Premontare il cuscinetto sul pignone (pos. ①, Fig. 60) e inserire a fondo il pignone nella sede sulla scatola riduttore (pos. ①, Fig. 61) mediante una massa battente.

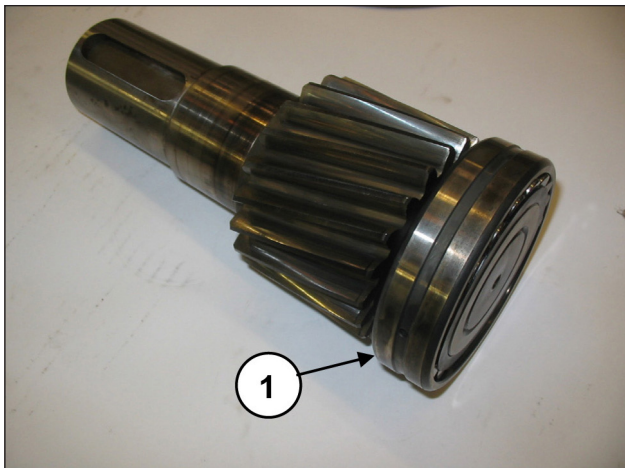

Fig. 60

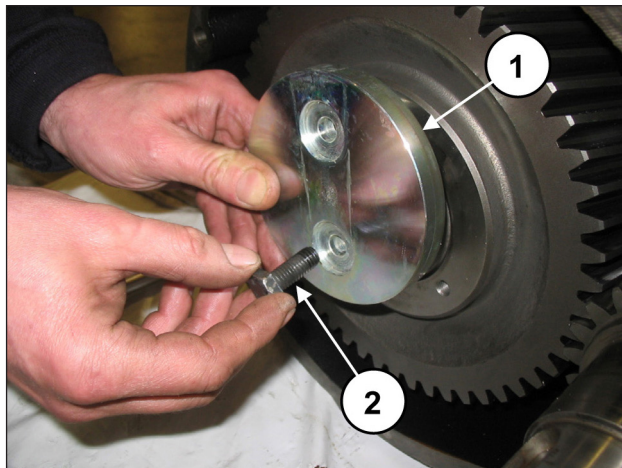

Fig. 63

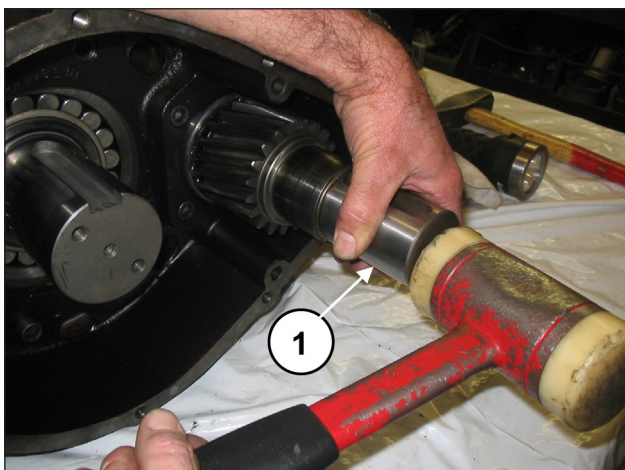

Fig. 61



Fig. 64

Applicare la linguetta 22x14x100 nella sede dell'albero (pos. ①, Fig. 62) e inserire la corona sull'albero. Fissare il fermo corona (pos. ①, Fig. 63) utilizzando le 2 viti M10x25 (pos. ②, Fig. 63). Tarare le viti con chiave dinamometrica come indicato nel capitolo 3.

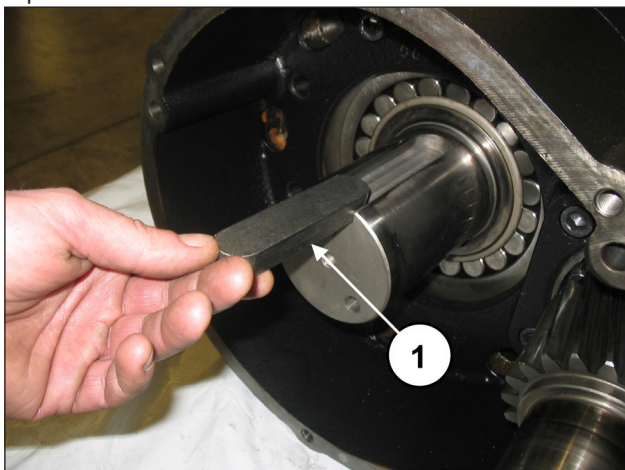

Fig. 62

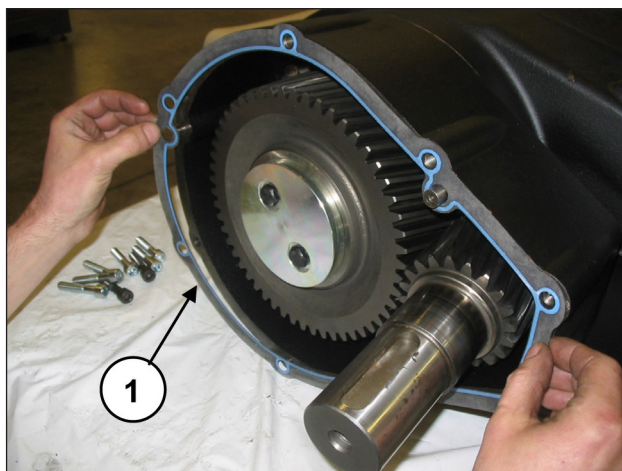

Fig. 65

Applicare le 3 spine $\varnothing 12 \times 40$ alla scatola riduttore (pos. ①, Fig. 64) e inserire la guarnizione (pos. ①, Fig. 65).

Montare il cuscinetto sul coperchio riduttore (pos. ①, Fig. 66).

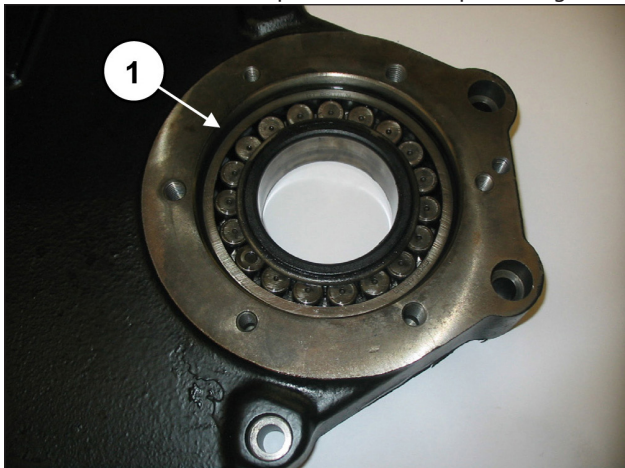

Fig. 66

Montare il coperchio riduttore (pos. ①, Fig. 67) e fissarlo mediante 8 viti M10x50 (pos. ①, Fig. 68). Utilizzare un tampone per evitare che il cuscinetto possa uscire dalla sua sede (pos. ①, Fig. 69).

Tarare le viti con chiave dinamometrica come indicato nel capitolo 3.

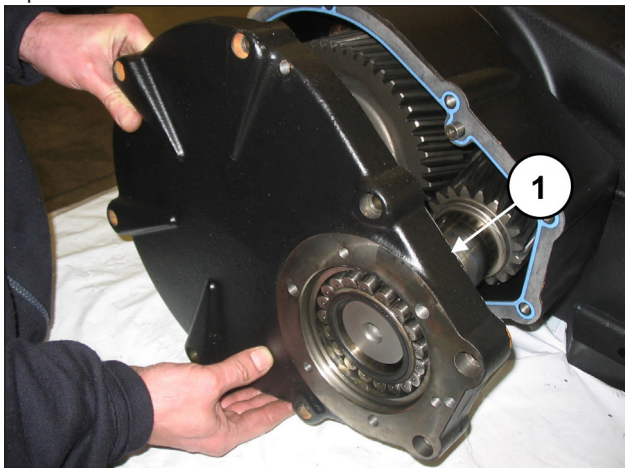

Fig. 67

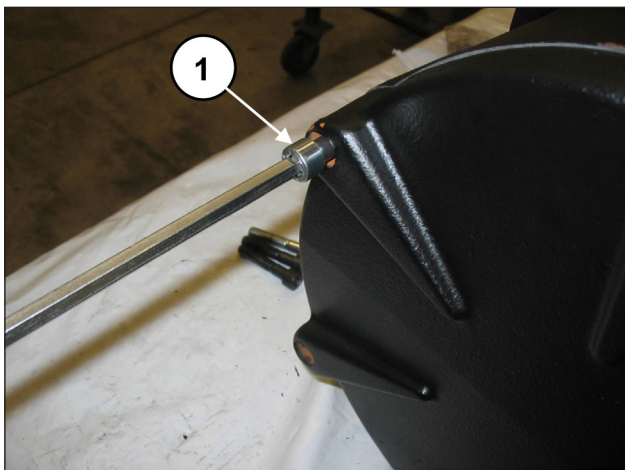

Fig. 68



Fig. 69

Inserire il paraolio all'interno della flangia riduttore mediante l'utilizzo degli attrezzi cod. 27515900 e 27548200 (pos. ①, Fig. 70).

Prima di procedere con il montaggio del paraolio verificare le condizioni del labbro di tenuta. Se si rende necessaria la sostituzione posizionare il nuovo anello sul fondo della cava come indicato in Fig. 71.



Qualora l'albero presentasse una usura diametrale corrispondente al labbro di tenuta per evitare l'operazione di rettifica si può posizionare l'anello in seconda battuta come indicato nella Fig. 71.

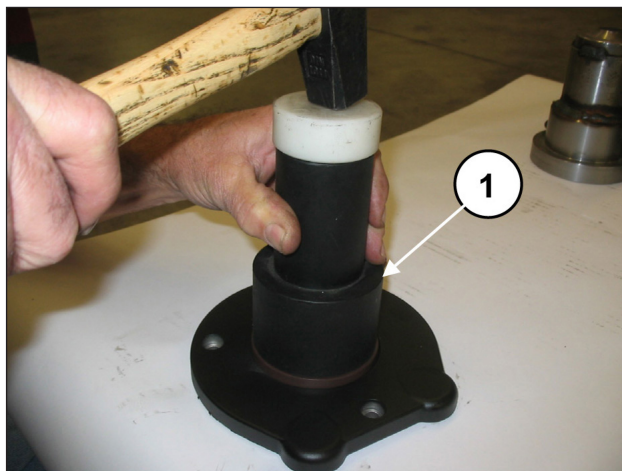

Fig. 70

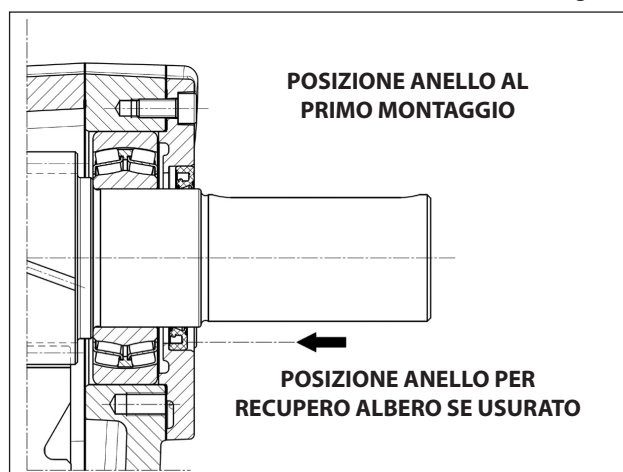

Fig. 71

Applicare la flangia riduttore con relativa guarnizione alla scatola riduttore (pos. ①, Fig. 72) ed avvitarela mediante 3 viti M8x18 (pos. ①, Fig. 73).



Per evitare di danneggiare il paraolio prestare particolare attenzione all'inserimento della flangia sul pignone

Tarare le viti con chiave dinamometrica come indicato nel capitolo 3.

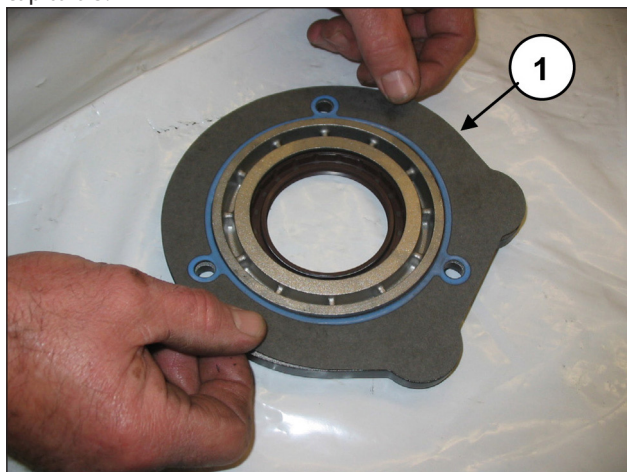

Fig. 72

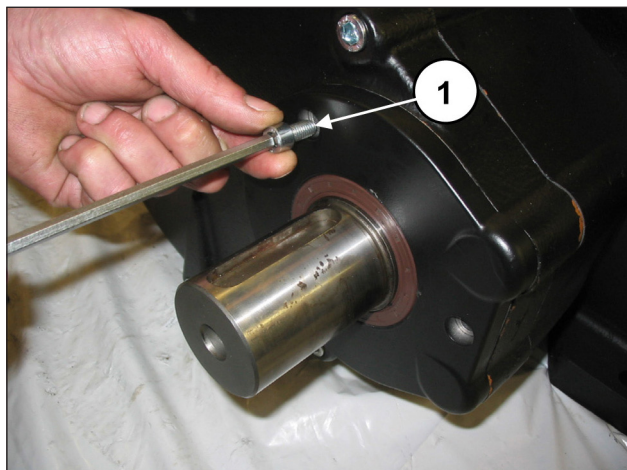

Fig. 73

Inserire la linguetta 16x10x90 nel pignone. Inserire l'O-ring nel coperchio posteriore (pos. ①, Fig. 74) e fissarlo al carter mediante 10 viti M8x18 (pos. ①, Fig. 75). Tarare le viti con chiave dinamometrica come indicato nel capitolo 3.

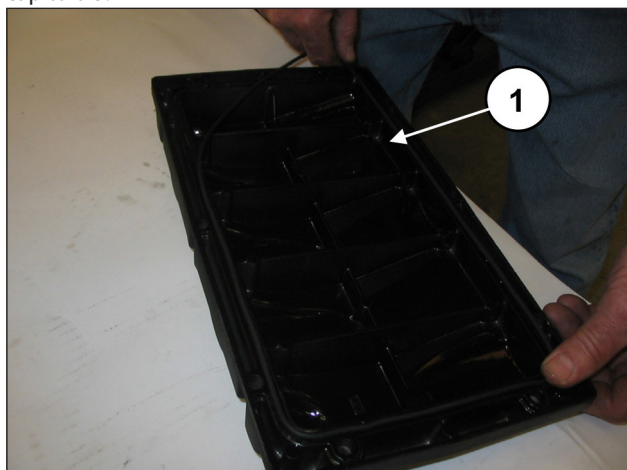

Fig. 74

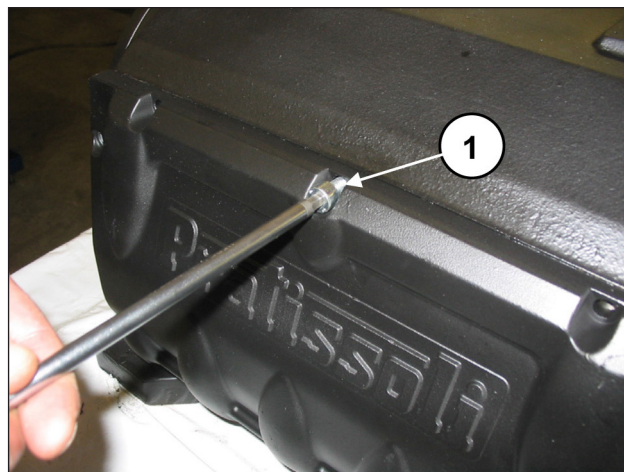

Fig. 75

Montare il coperchio cuscinetto (e relativa guarnizione) (pos. ①, Fig. 76) mediante 8 viti M12x30 (pos. ①, Fig. 77). Tarare le viti con chiave dinamometrica come indicato nel capitolo 3.



Fig. 76



Fig. 77

Completare il montaggio della parte meccanica applicando i tappi e i golfari di sollevamento con relativo O-ring di tenuta. Inserire l'olio nel carter come indicato nel **Manuale uso e manutenzione**, par. 7.4.

2.1.3 Classi di maggiorazione previste

TABELLA MAGGIORAZIONE PER ALBERO A GOMITI E SEMICUSCINETTI DI BIELLA			
Classi di recupero (mm)	Codice Semicuscinetto Superiore	Codice Semicuscinetto Inferiore	Rettifica sul diametro perno dell'albero (mm)
0.25	90931100	90930100	Ø92.75 0/-0.03 Ra 0.4 Rt 3.5
0.50	90931200	90930200	Ø92.50 0/-0.03 Ra 0.4 Rt 3.5

TABELLA MAGGIORAZIONE PER CARTER POMPA E GUIDA PISTONE		
Classi di recupero (mm)	Codice Guida Pistone	Rettifica sulla sede Carter Pompa (mm)
1.00	79050543	Ø81 H6 +0.022/0 Ra 0.8 Rt 6

2.2 RIPARAZIONE DELLA PARTE IDRAULICA

2.2.1 Smontaggio della testata - gruppi valvole

La testata necessita di una manutenzione preventiva come indicato nel *Manuale uso e manutenzione*.

Gli interventi sono limitati all'ispezione o sostituzione delle valvole, qualora necessario.

Per l'estrazione dei gruppi valvola operare come segue:

Svitare le 8 viti M16x55 del coperchio valvole (pos. ①, Fig. 78) e rimuovere il coperchio (pos. ①, Fig. 79).

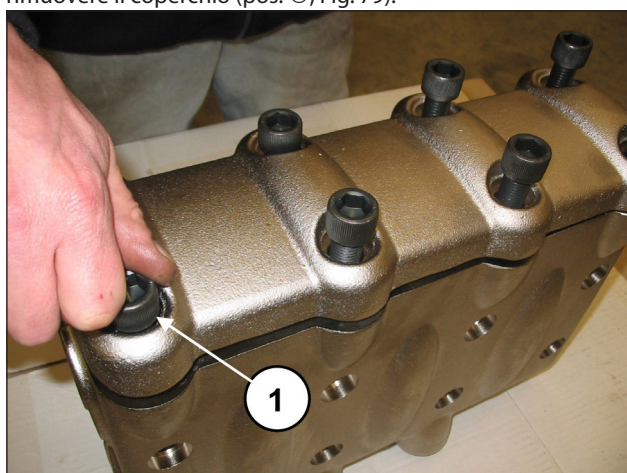

Fig. 78

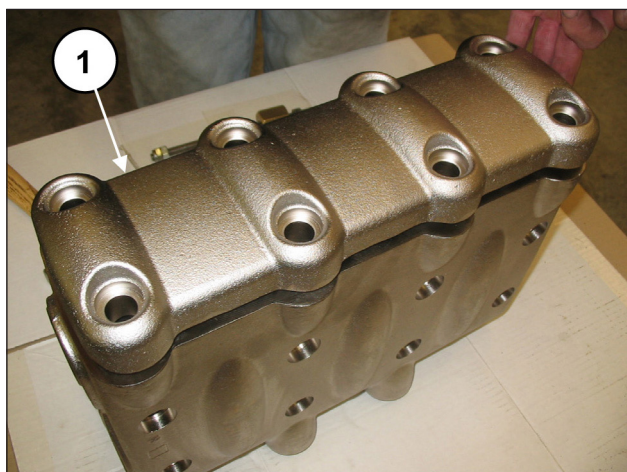

Fig. 79

Estrarre il tappo valvola mediante l'utilizzo di un estrattore a massa battente da applicare al foro M10 del tappo valvola (pos. ①, Fig. 80).

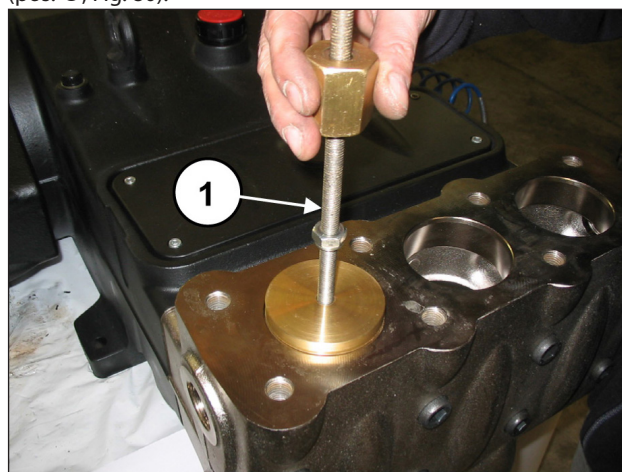

Fig. 80

Sfilare la molla (pos. ①, Fig. 81).

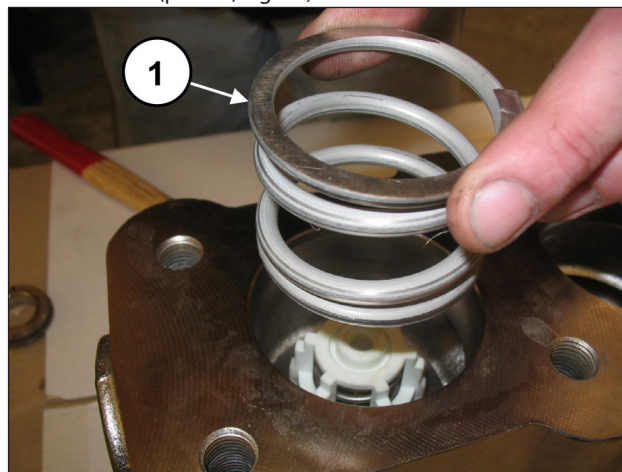

Fig. 81

Estrarre il gruppo valvola mandata mediante l'utilizzo di un estrattore a massa battente da applicare al foro M10 del guida valvola (pos. ①, Fig. 82).

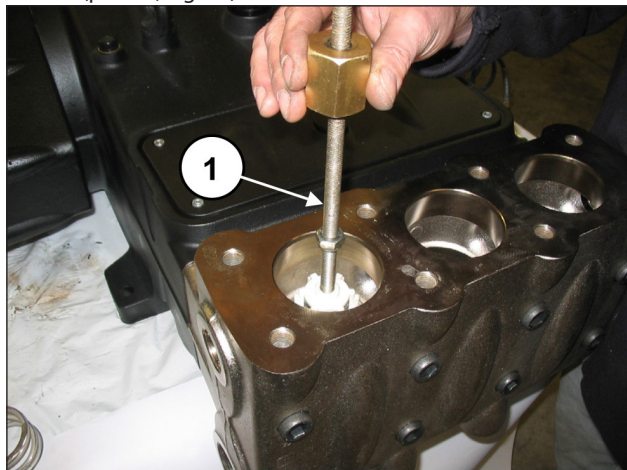

Fig. 82



Qualora l'estrazione del gruppo valvola di mandata risultasse particolarmente difficoltosa (ad es. per incrostazioni dovute ad un prolungato inutilizzo della pompa) utilizzare l'attrezzo estrattore cod. 27516400.

Estrarre il distanziale guida valvola mediante l'utilizzo di una chiave esagonale da 8 mm (pos. ①, Fig. 83).

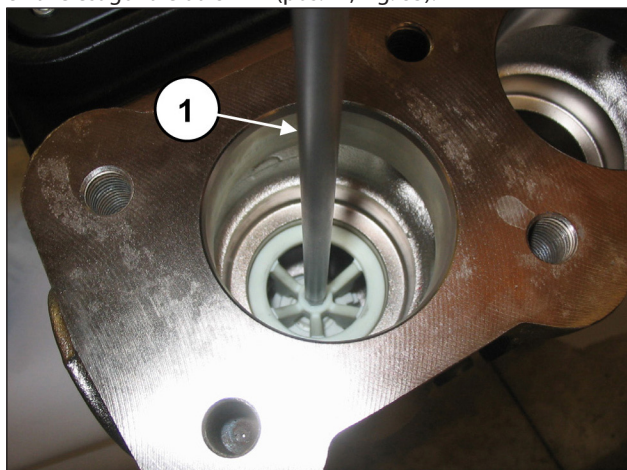

Fig. 83

Estrarre il gruppo valvola aspirazione mediante l'utilizzo di un estrattore a massa battente da applicare al foro M10 del guida valvola (pos. ①, Fig. 84).

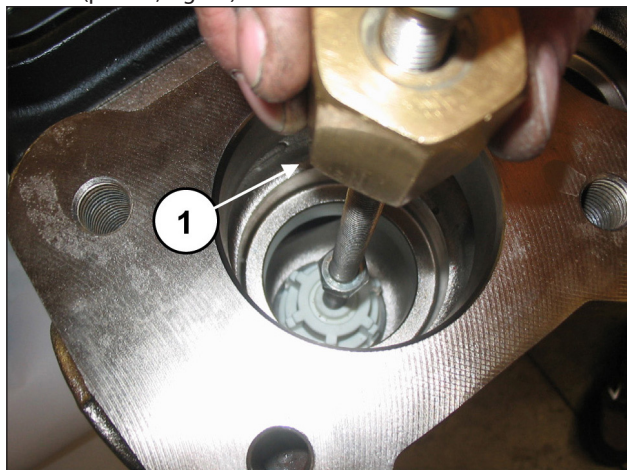

Fig. 84



Qualora l'estrazione del gruppo valvola di aspirazione risultasse particolarmente difficoltosa (ad es. per incrostazioni dovute ad un prolungato inutilizzo della pompa) utilizzare l'attrezzo estrattore cod.27516200 (nelle versioni con Ø Pistone: 40 - 45 - 50) o cod.27516300 (nelle versioni con Ø Pistone: 55 - 60 - 65).

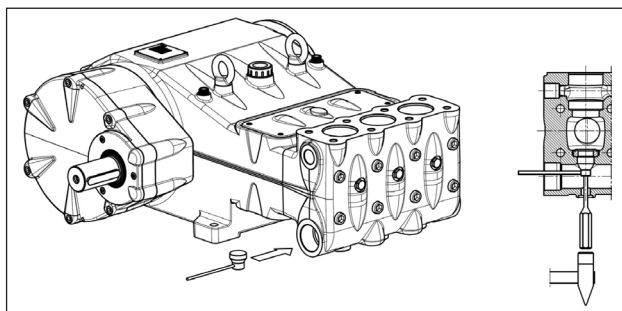

Fig. 85

Svitare il dispositivo apertura valvole mediante chiave da 30 mm (pos. ①, Fig. 86).

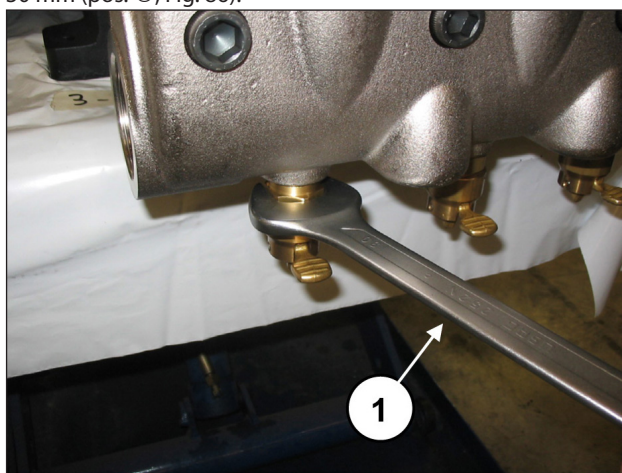

Fig. 86

Smontare i gruppi valvola di aspirazione e mandata avvitando una vite M10 in modo da premere sulla guida interna ed estrarre il guida valvola dalla sede valvola (pos. ①, Fig. 87).

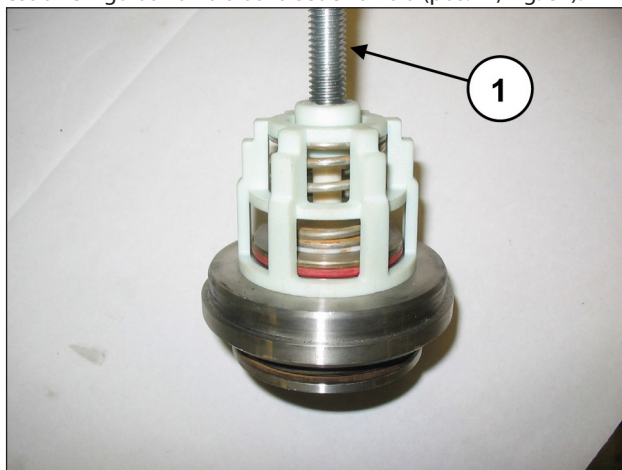

Fig. 87

2.2.2 Montaggio della testata - gruppi valvole



Prestare particolare attenzione allo stato di usura dei vari componenti e sostituirli qualora necessario.

Ad ogni ispezione delle valvole sostituire tutti gli O-ring sia dei gruppi valvola che dei tappi valvola.



Prima di riposizionare i gruppi valvola pulire ed asciugare perfettamente i relativi alloggiamenti nella testata indicati dalle frecce (pos. ①, Fig. 88).

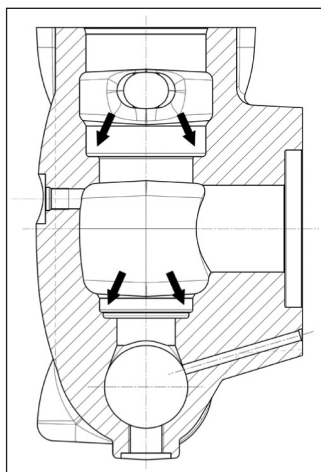

Fig. 88

Procedere al rimontaggio seguendo il procedimento inverso allo smontaggio indicato al par. 2.2.1.

Assemblare i gruppi valvola di aspirazione e mandata (Fig. 89 e Fig. 90) prestando attenzione a non invertire le molle precedentemente smontate.

Per facilitare l'inserimento della guida valvola nella sede si può utilizzare un tubo che appoggi sui pianetti orizzontali della guida (Fig. 91) e utilizzare una massa battente agendo su tutta la circonferenza



Fig. 89



Fig. 90

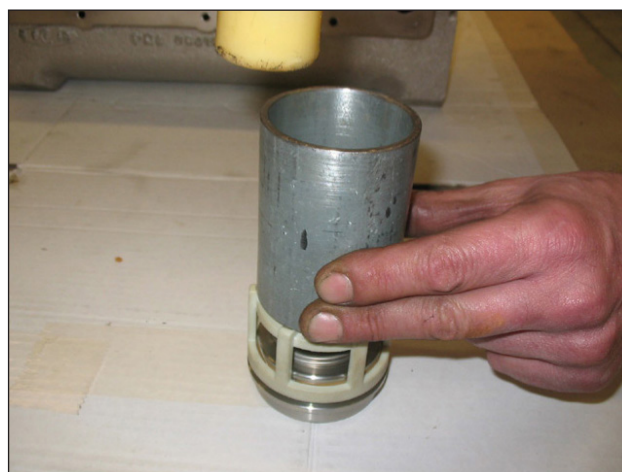

Fig. 91



Procedere con l'inserimento dei gruppi valvola (aspirazione e mandata) nella testata prestando attenzione alla sequenza corretta di inserimento degli O-ring e degli anelli antiestrusione.

La corretta sequenza di montaggio dei gruppi valvola nella testata è la seguente:

Inserire l'anello antiestrusione, pos. esplosivo n. 4 (pos. ①, Fig. 92).

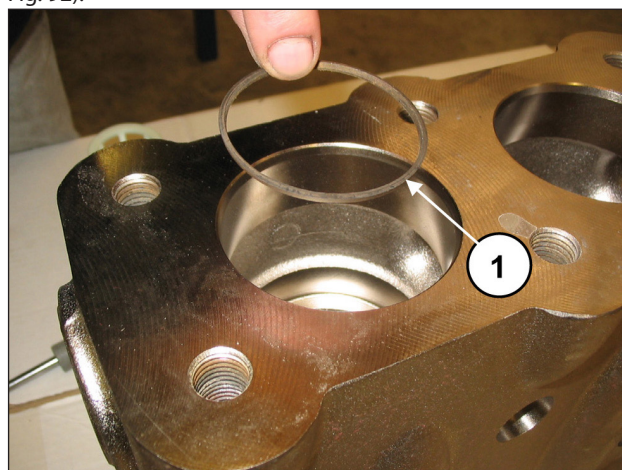

Fig. 92

Inserire l'O-ring, pos. esploso n. 5 (pos. ①, Fig. 93).

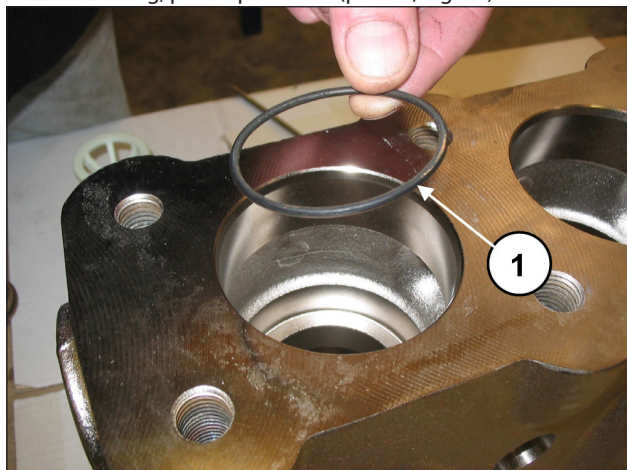

Fig. 93

Accertarsi che O-ring e anello antiestrusione vengano alloggiati perfettamente in sede.

Inserire il gruppo valvola di aspirazione (pos. ①, Fig. 94) e successivamente il distanziale (pos. ①, Fig. 95).

Il gruppo valvola completo deve essere inserito completamente a fondo e presentarsi come in pos. ①, Fig. 95.

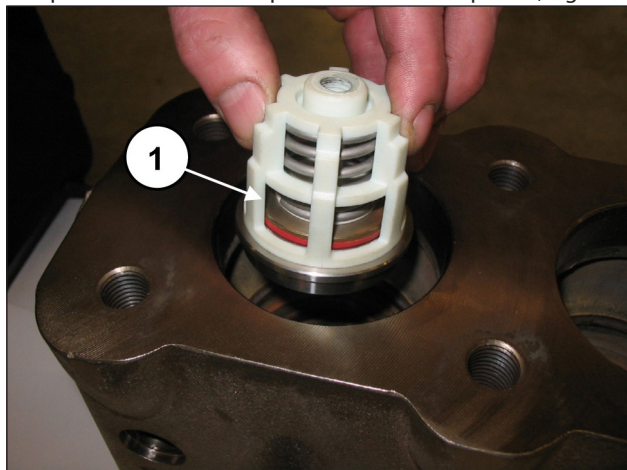

Fig. 94

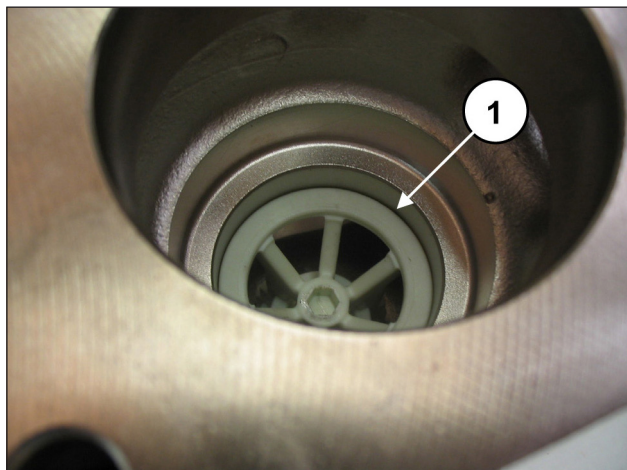

Fig. 95

Montare O-ring, pos. esploso n. 5 (pos. ①, Fig. 96) e anello antiestrusione, pos. esploso n. 15 (pos. ②, Fig. 96) sulla sede valvola di mandata.

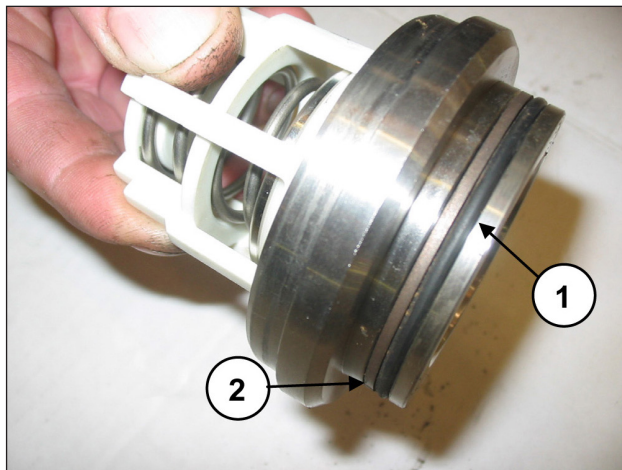

Fig. 96

Inserire il gruppo valvola di mandata (pos. ①, Fig. 97). Il gruppo valvola deve essere inserito completamente a fondo e presentarsi come in pos. ①, Fig. 98.

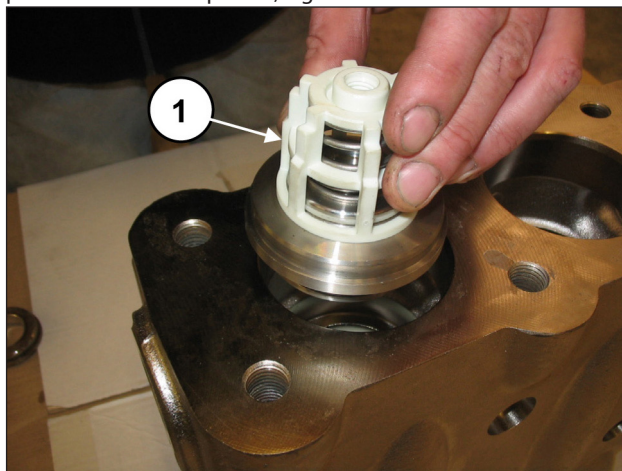

Fig. 97

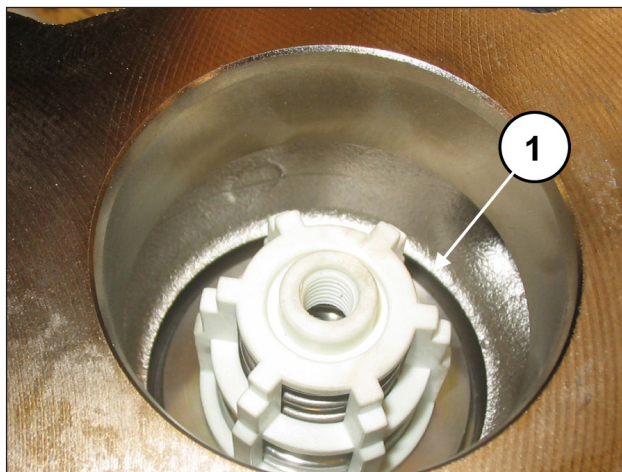

Fig. 98

Inserire l'anello antiestrusione, pos. esploso n. 16 (pos. ①, Fig. 99).

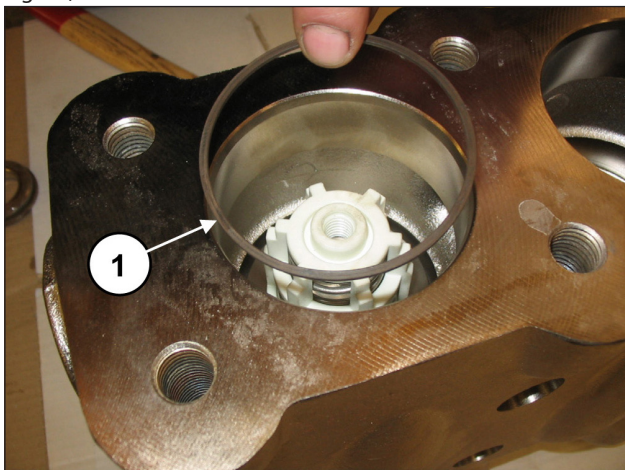

Fig. 99

Inserire l'anello sede valvola (pos. ①, Fig. 102) e la molla (pos. ①, Fig. 103).

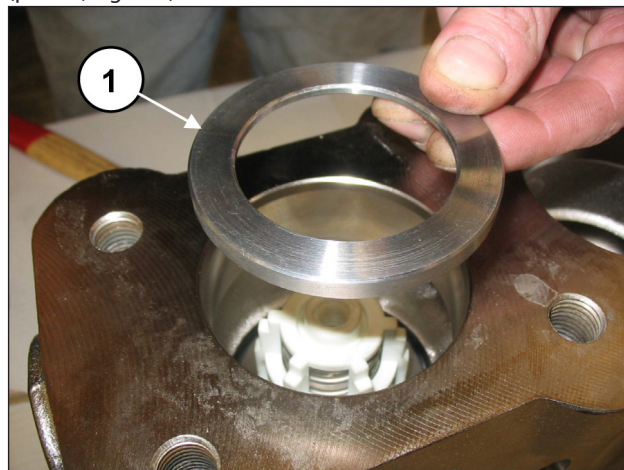

Fig. 102

Inserire l'O-ring, pos. esploso n. 17 (pos. ①, Fig. 100).

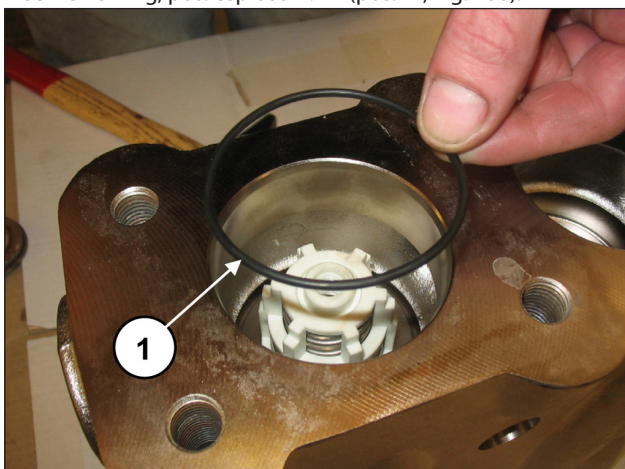

Fig. 100

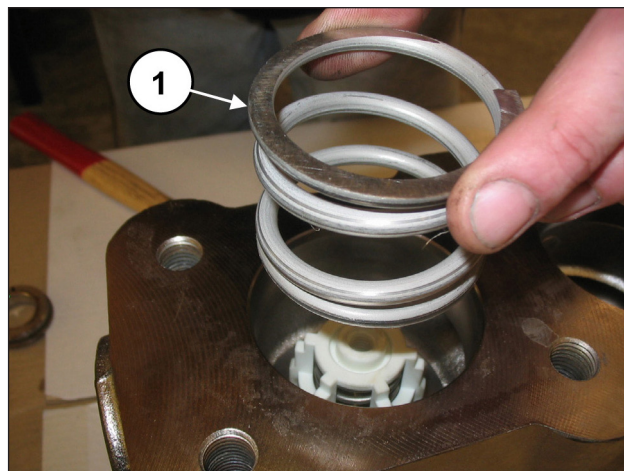

Fig. 103



Prestare particolare attenzione all'inserimento dell'O-ring indicato in pos. ①, Fig. 101. Si consiglia l'utilizzo dell'attrezzo cod. 27516000 (nelle versioni con Ø Pistone: 40 - 45 - 50) o cod.27516100 (nelle versioni con Ø Pistone: 55 - 60 - 65) per evitare che l'O-ring possa tagliarsi durante l'inserimento.

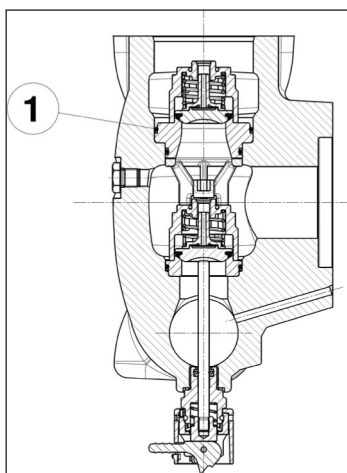

Fig. 101

Montare O-ring, pos. esploso n. 17 (pos. ①, Fig. 104) e anello antiestrusione, pos. esploso n. 21 (pos. ②, Fig. 104) sul tappo valvola di mandata.

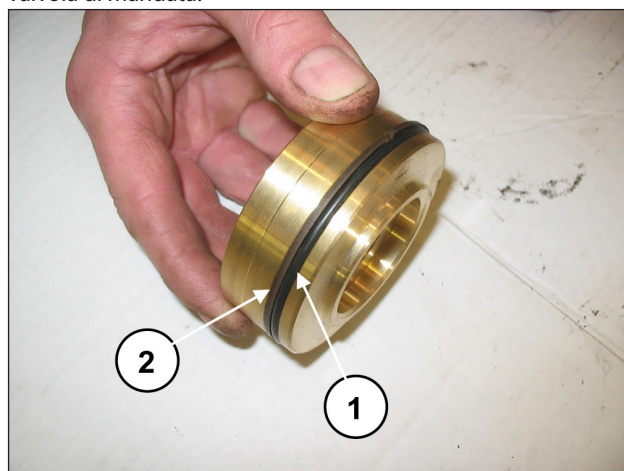

Fig. 104

Inserire il tappo valvola completo di O-ring e anelli antiestrusione.

Dopo aver terminato il montaggio dei gruppi valvola e del tappo valvola applicare il coperchio valvole (pos. ①, Fig. 105) e avvitare le 8 viti M16x55 (pos. ①, Fig. 106).

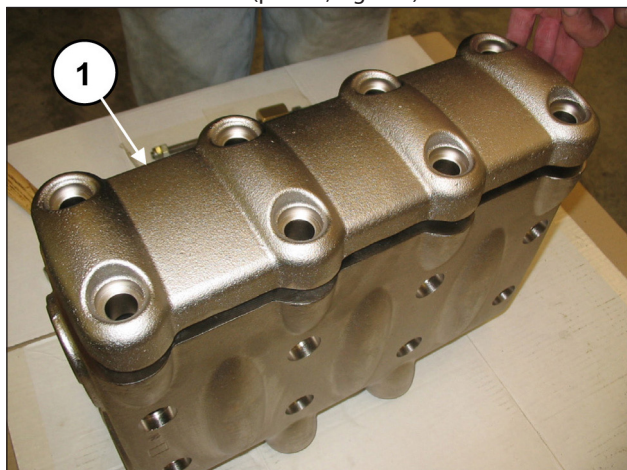

Fig. 105

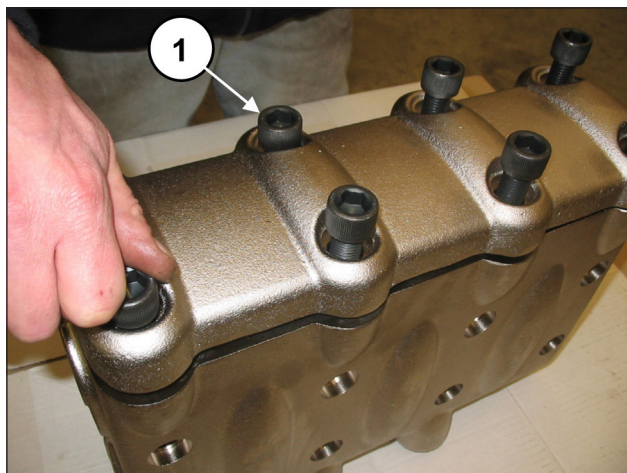

Fig. 106

Montare la testata sul carter pompa (pos. ①, Fig. 107) facendo attenzione a non urtare i pistoni ed avvitare le 8 viti M16x180 (pos. ①, Fig. 108).

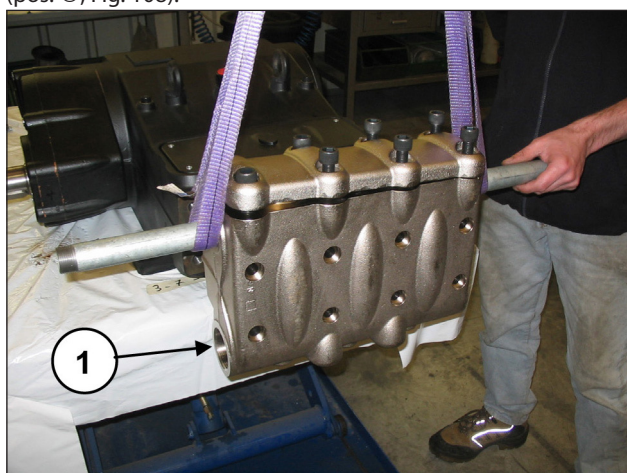

Fig. 107

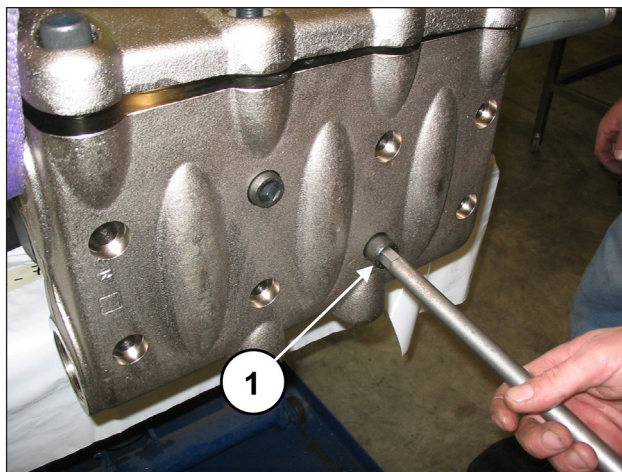

Fig. 108

Procedere alla taratura delle viti M16x180 con chiave dinamometrica come indicato nel capitolo 3.



Serrare le 8 viti M16x180 partendo dalle 4 viti interne in modo incrociato (vedere Fig. 107), per poi proseguire con le 4 viti esterne, sempre serrando in modo incrociato

Tarare le viti M16x55 del coperchio con chiave dinamometrica come indicato nel capitolo 3.

Applicare i dispositivi apertura valvole (pos. ①, Fig. 109) ed avvitarli mediante chiave da 30 mm (pos. ①, Fig. 110).

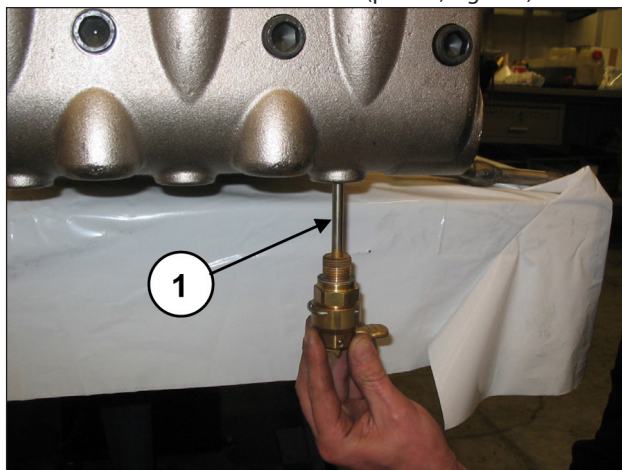

Fig. 109

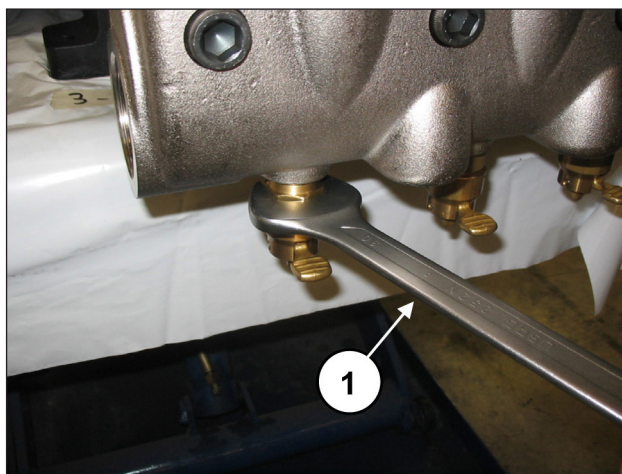

Fig. 110

2.2.3 Smontaggio del gruppo pistone - supporti - tenute

Il gruppo pistone necessita di una verifica periodica come indicato nella tabella di manutenzione preventiva del **Manuale uso e manutenzione**.

Gli interventi sono limitati al solo controllo visivo dell'eventuale drenaggio dal foro presente sul coperchio inferiore. Qualora si presentassero anomalie / oscillazioni sul manometro di mandata o gocciolamenti dal foro di drenaggio, sarà necessario procedere al controllo e alla eventuale sostituzione del pacco tenute.

Per l'estrazione dei gruppi pistone operare come segue:
Per accedere al gruppo pistone occorre svitare le viti M16x180 e smontare la testata.



Sfilare la testata con il massimo di attenzione per evitare di urtare i pistoni

Provvedere allo smontaggio dei pistoni svitando le viti di fissaggio (pos. ①, Fig. 111).

Sfilare il pistone dal supporto guarnizioni e controllare che la superficie dello stesso non presenti graffi, segni di usura o di cavitazione

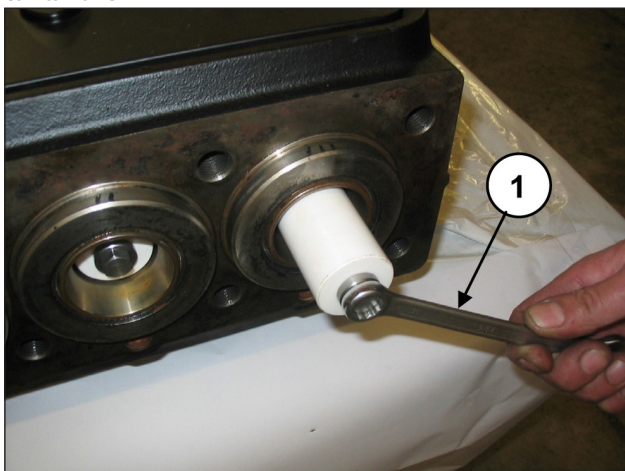

Fig. 111

Rimuovere il coperchio di ispezione superiore svitando le 4 viti di fissaggio (pos. ①, Fig. 112).

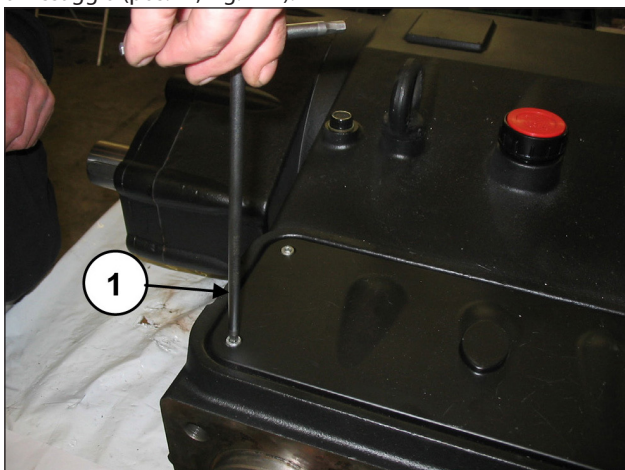

Fig. 112

Ruotare manualmente l'albero in modo da portare i 3 pistoni nella posizione di punto morto superiore. Inserire l'attrezzo tampone cod. 27516600 tra il guida pistone e il pistone (pos. ①, Fig. 113).

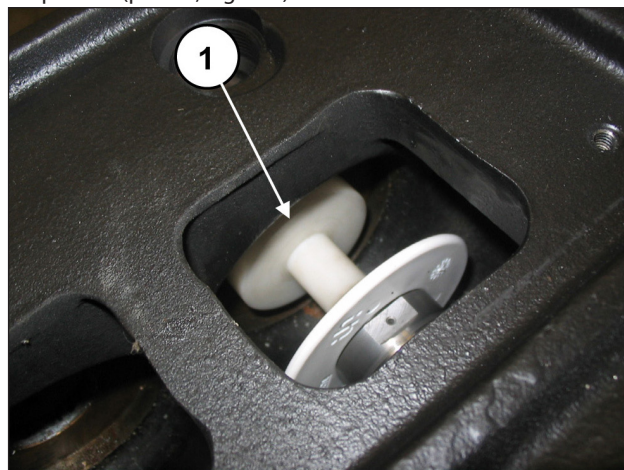

Fig. 113

Ruotando l'albero, fare avanzare il guida pistone in modo che il tampone, avanzando a sua volta, possa espellere il supporto guarnizioni e tutto il gruppo pistone (pos. ①, Fig. 114).

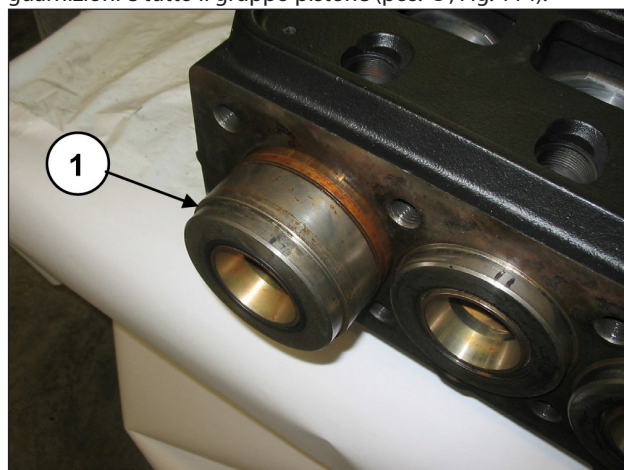

Fig. 114

Estrarre il gruppo supporto guarnizioni e l'attrezzo tampone. Rimuovere l'O-ring di fondo supporto guarnizione qualora rimanesse all'interno del carter pompa (pos. ①, Fig. 115).

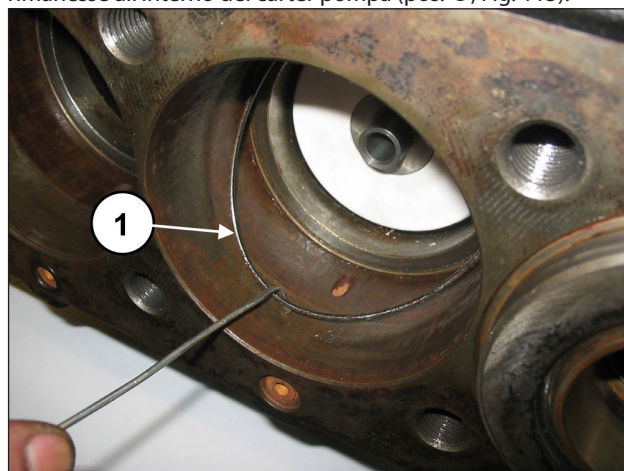

Fig. 115

Sfilare dai guida pistoni gli anelli paraspruzzi (pos. ①, Fig. 116).

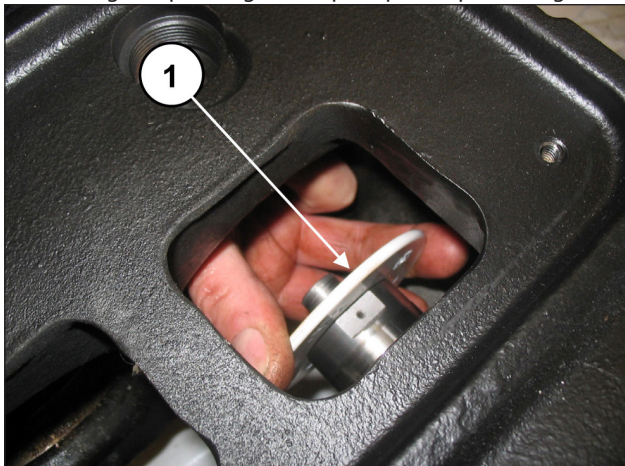

Fig. 116

Qualora fosse necessaria la sostituzione del paraolio del guida pistone occorre smontare il coperchio paraolio procedendo nel seguente modo:

Svitare le due viti di bloccaggio del coperchio paraolio (pos. ①, Fig. 117).

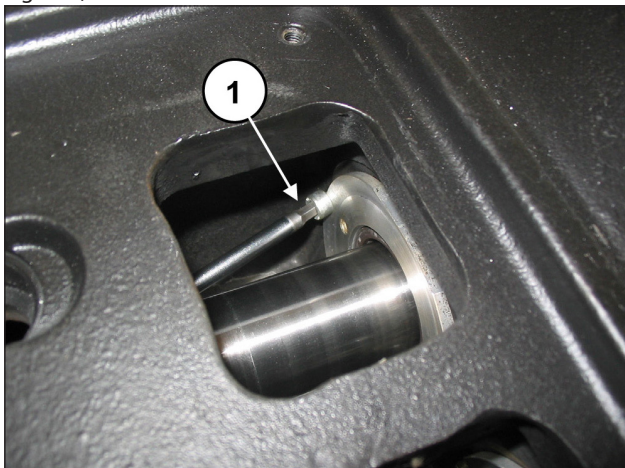

Fig. 117

Posizionare la guida pistone al punto morto inferiore, avvitare l'estrattore cod. 27516400 compreso di adattatore M5 cod. 27516500 negli appositi fori posti sul coperchio (pos. ①, Fig. 118) ed estrarre il coperchio paraolio dal gruppo pompa (pos. ①, Fig. 119).

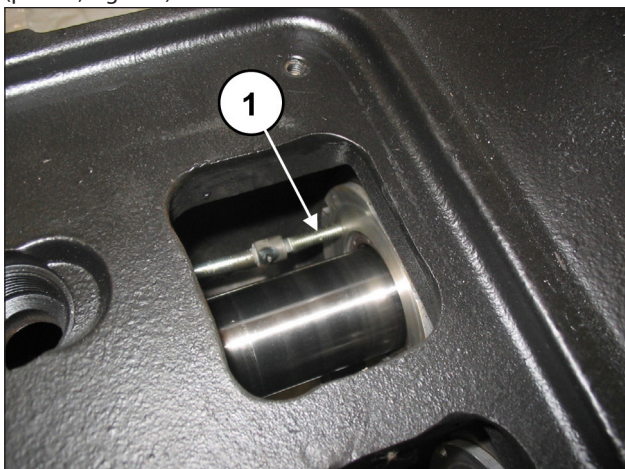

Fig. 118



Fig. 119

Sostituire il paraolio (pos. ①, Fig. 120) e l'O-ring esterno (pos. ②, Fig. 120).

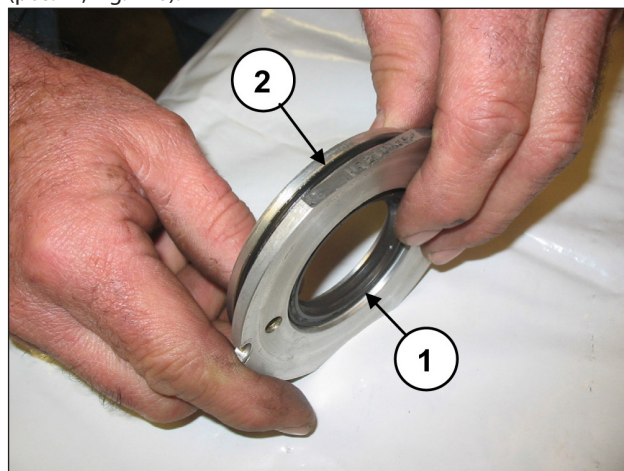

Fig. 120

Separare il supporto guarnizioni dalla camicia (pos. ①, Fig. 121) per accedere alle guarnizioni di pressione (pos. ①, Fig. 122).

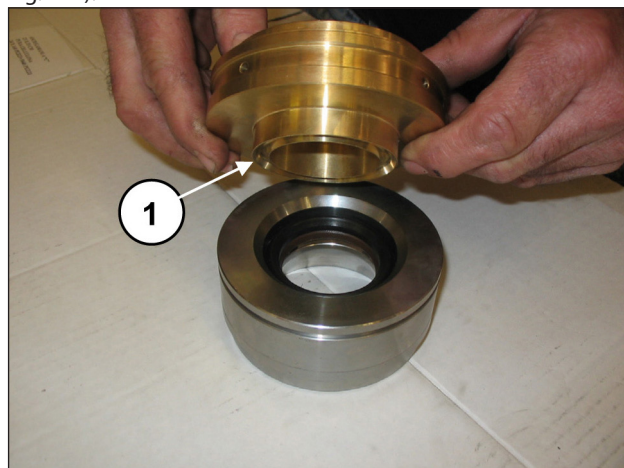

Fig. 121

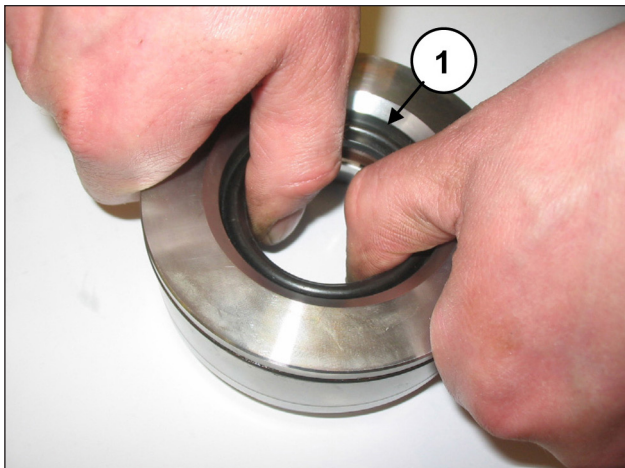

Fig. 122

Per togliere la guarnizione di bassa pressione è necessario utilizzare uno spessimetro o un attrezzo che non danneggi la sede del supporto guarnizione (pos. ①, Fig. 123).

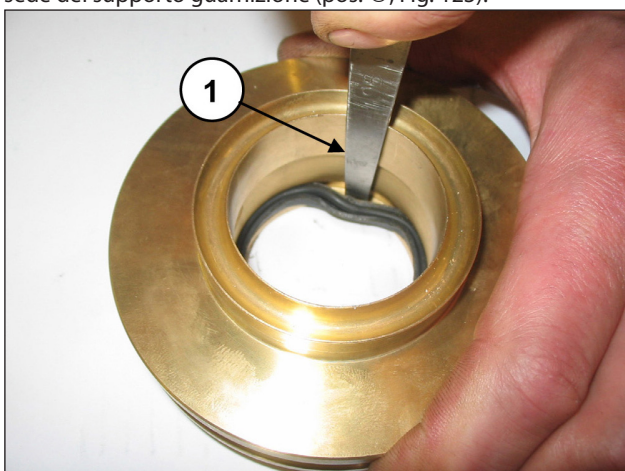

Fig. 123

2.2.4 Montaggio del gruppo pistone - supporti - tenute

Procedere al rimontaggio seguendo il procedimento inverso allo smontaggio indicato al par. 2.2.3.



Sostituire le guarnizioni di pressione inumidendone i labbri con grasso al silicone (senza cospargerle), facendo molta attenzione a non danneggiarle durante l'inserimento nella camicia.



Ad ogni smontaggio le guarnizioni di pressione devono essere sempre sostituite assieme a tutti gli O-ring.

Inserire la guarnizione di bassa pressione nel supporto guarnizione (pos. ①, Fig. 124) facendo attenzione al senso di montaggio che prevede il labbro di tenuta in avanti (verso la testata).

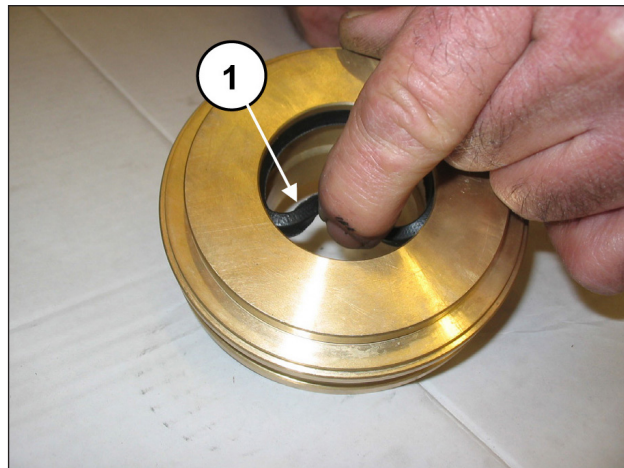

Fig. 124

Montare l'anello di testa (pos. ①, Fig. 125), la guarnizione di alta pressione (pos. ①, Fig. 126) e l'anello restop (pos. ①, Fig. 127).



Fig. 125

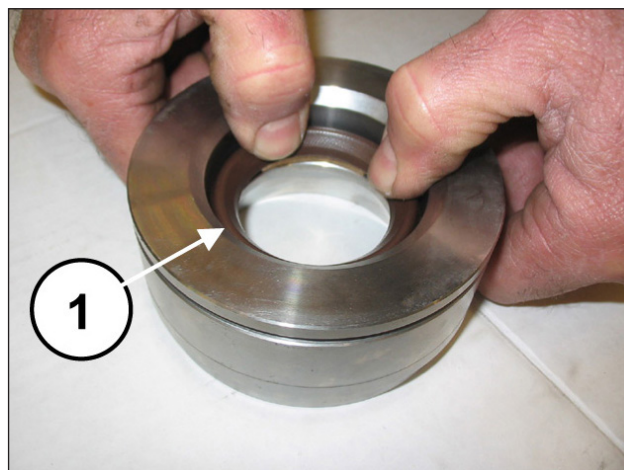

Fig. 126



Fig. 127

Unire il supporto guarnizioni alla camicia (pos. ①, Fig. 128).

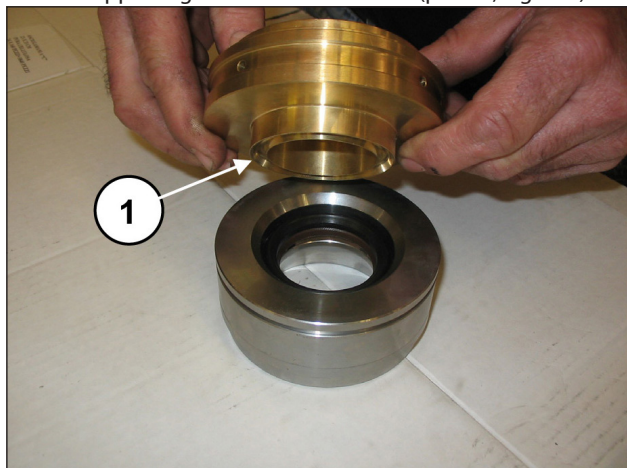

Fig. 128

Montare il paraolio nel coperchio paraolio (pos. ①, Fig. 129) mediante l'utilizzo di un tampone cod. 27910900.

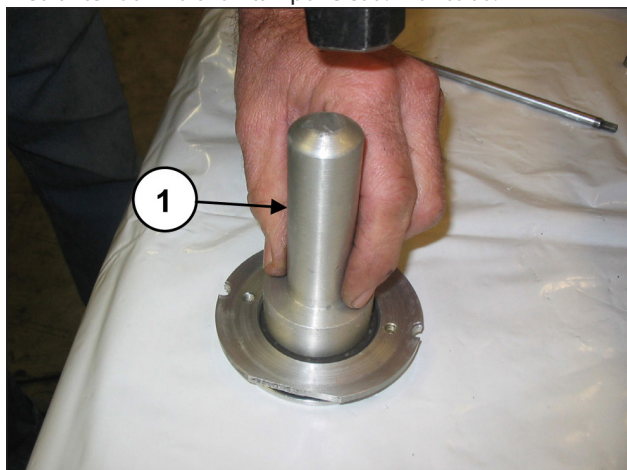

Fig. 129

Posizionare l'O-ring (pos. ①, Fig. 130) nella sede del coperchio paraolio ed inserire il gruppo montato all'interno del carter nell'apposita sede (pos. ①, Fig. 131).

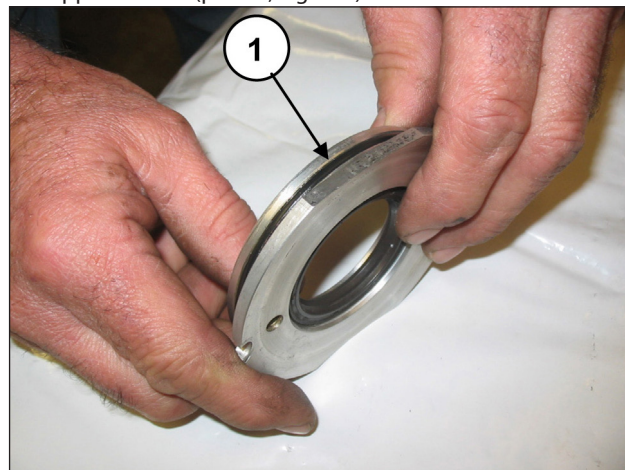

Fig. 130

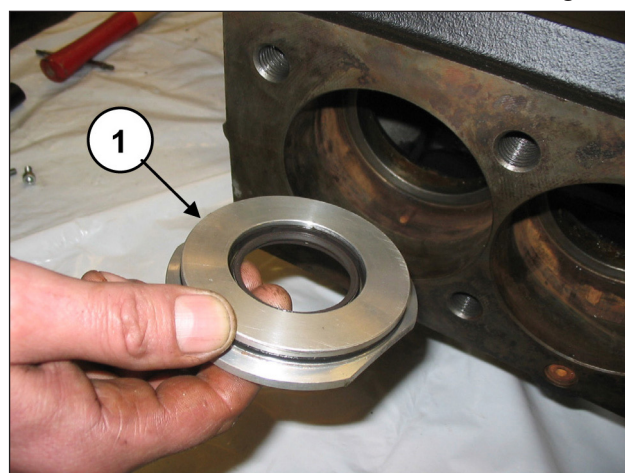

Fig. 131

Assicurarsi che il coperchio entri completamente in sede (pos. ①, Fig. 132) facendo attenzione a non danneggiare il labbro del paraolio. Avvitare i coperchi paraolio mediante 2 viti M6x14 (pos. ①, Fig. 133).

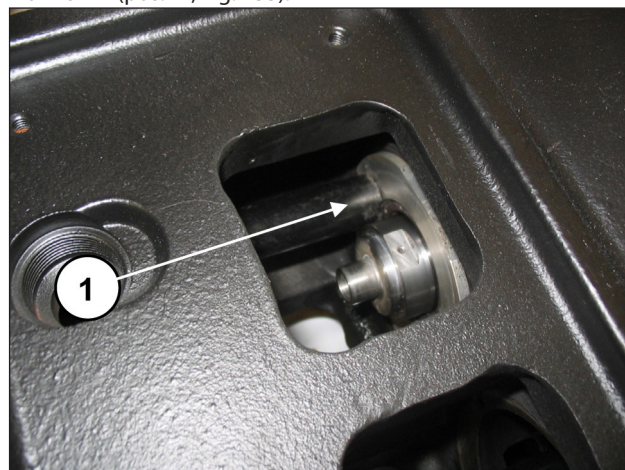

Fig. 132

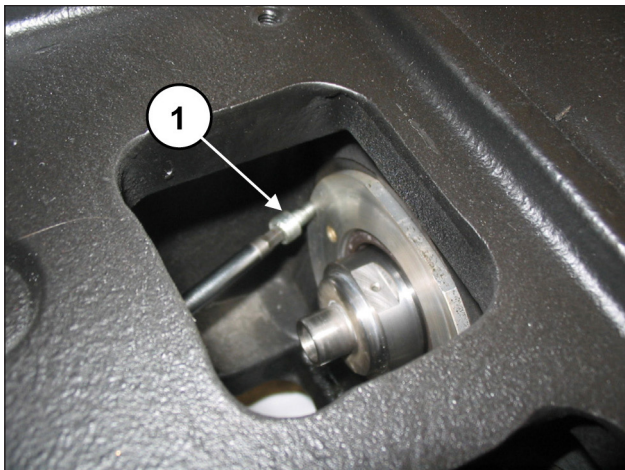

Fig. 133

Tarare le viti con chiave dinamometrica come indicato nel capitolo 3.

Posizionare il paraspruzzi completo di O-ring nell'alloggiamento sul guida pistone (pos. ①, Fig. 134 e Fig. 135).

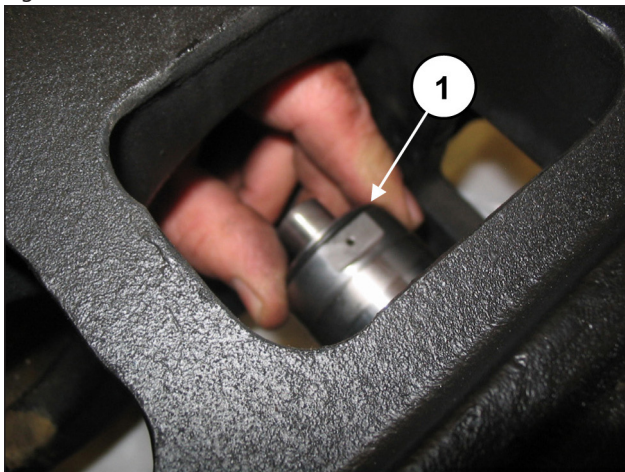

Fig. 134

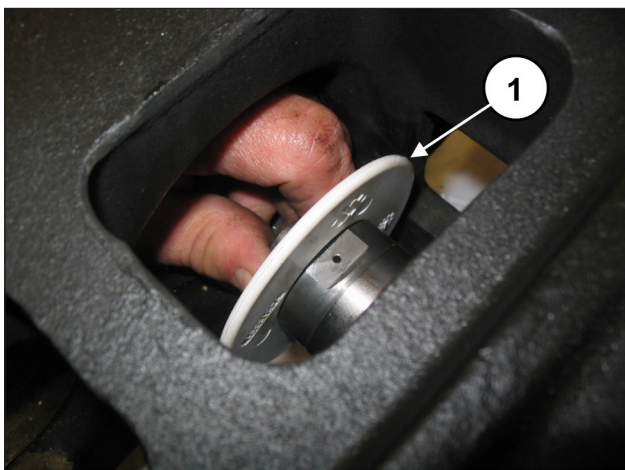

Fig. 135

Inserire la rosetta $\varnothing 10 \times 18 \times 0.9$ nella vite fissaggio pistone (pos. ①, Fig. 136).

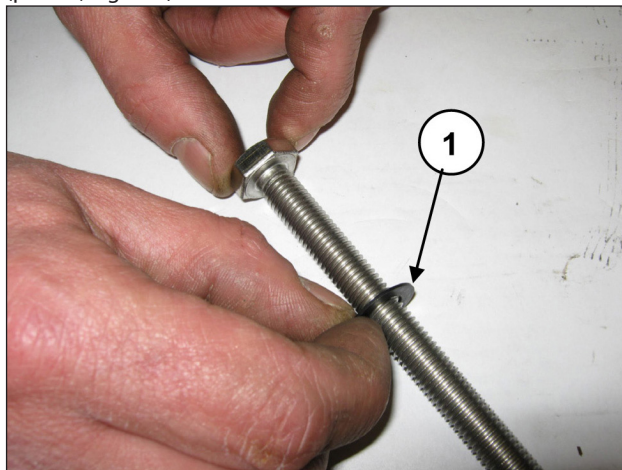

Fig. 136

Montare i pistoni sulle rispettive guide (pos. ①, Fig. 137) e fissarli come da pos. ①, Fig. 138.

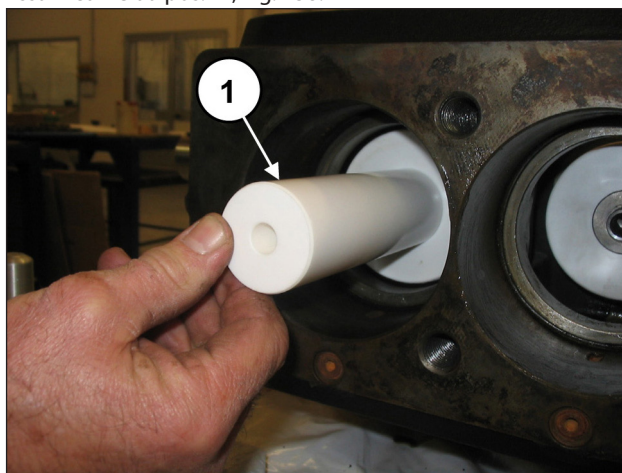

Fig. 137

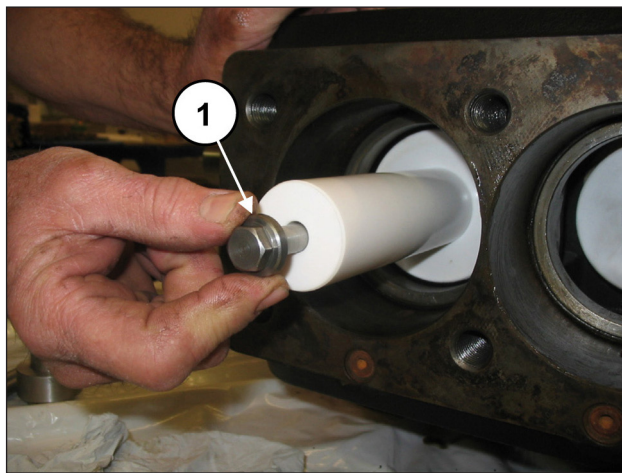

Fig. 138

Tarare le viti con chiave dinamometrica come indicato nel capitolo 3.

Inserire l'O-ring all'interno del carter pompa (pos. ①, Fig. 139) e successivamente il blocco camicia-supporto guarnizione (completo del medesimo O-ring) precedentemente assemblato fino a battuta (pos. ①, Fig. 140).

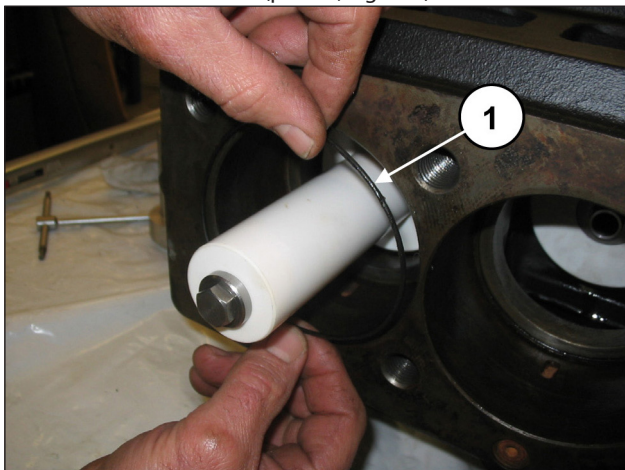

Fig. 139

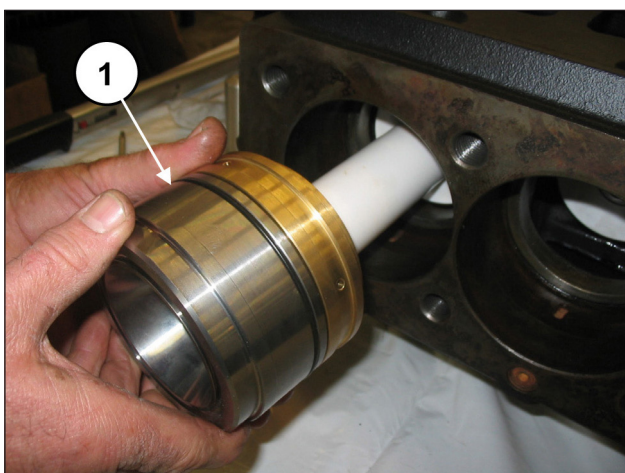

Fig. 140

Assicurarsi che il blocco camicia-supporto arrivi a posizionarsi correttamente fino a fondo sede (pos. ①, Fig. 141).

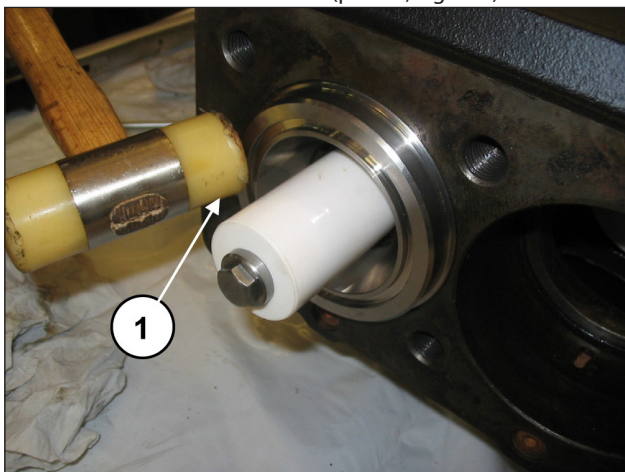

Fig. 141

Montare l'O-ring frontale della camicia (pos. ①, Fig. 142) e l'O-ring del foro di ricircolo (pos. ①, Fig. 143).



Fig. 142

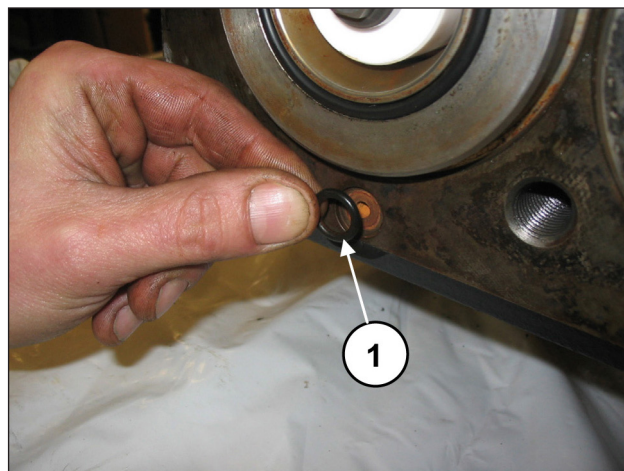

Fig. 143

Sui coperchi ispezione inserire l'O-ring (pos. ①, Fig. 144) e montare i coperchi mediante l'utilizzo di 4+4 viti M6x14 (pos. ①, Fig. 145).

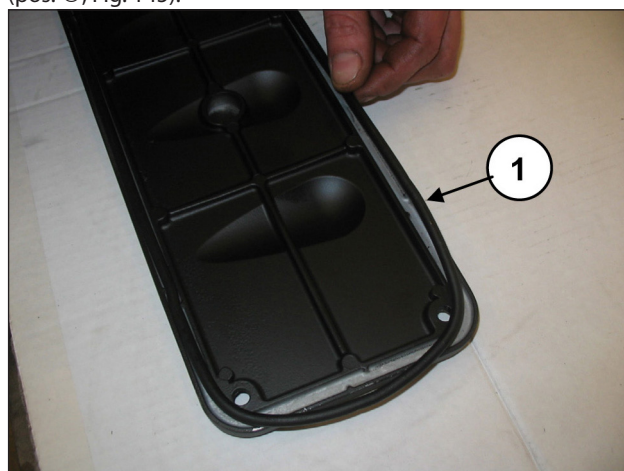

Fig. 144



Fig. 145

Tarare le viti con chiave dinamometrica come indicato nel capitolo 3.

2.2.5 Recupero testate

Qualora la testata presentasse all'interno delle camere dei pistoni evidenti segni di cavitazione, dovuti ad una non corretta alimentazione della pompa, è possibile recuperare la testata danneggiata evitandone la sostituzione.

Per il recupero della testata eseguire le lavorazioni indicate in Fig. 146 nelle versioni con pistone $\varnothing 40-45-50$ e indicate in Fig. 147 con pistone $\varnothing 55-60-65$:

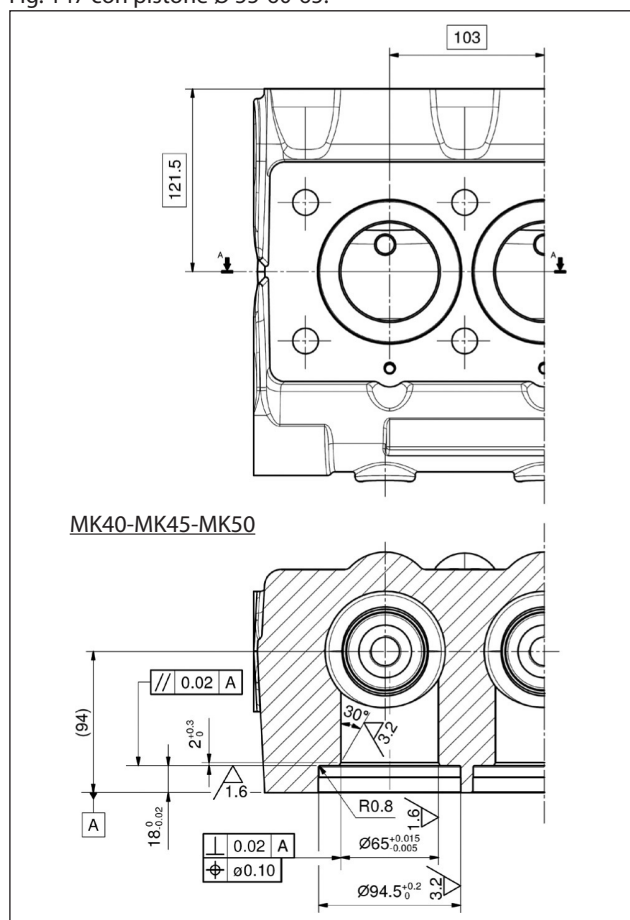

Fig. 146

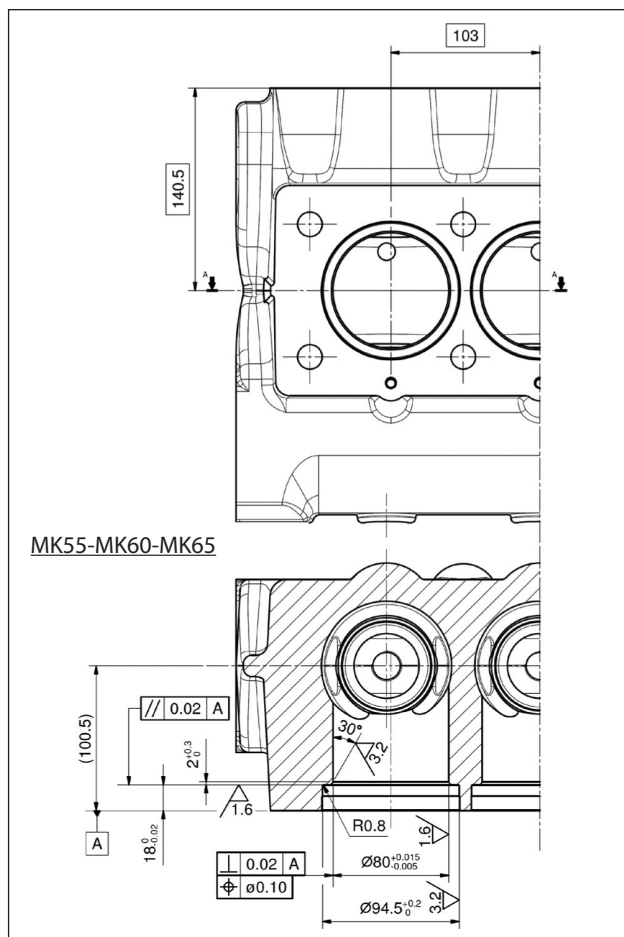

Fig. 147

La testata lavorata deve essere assemblata mediante piantaggio delle boccole (pos. ①) complete di anelli antiestrusione (pos. ②) e O-ring (pos. ③) come rappresentato in Fig. 148 nelle versioni con pistone $\varnothing 40-45-50$ e in Fig. 149 nelle versioni con pistone $\varnothing 55-60-65$:

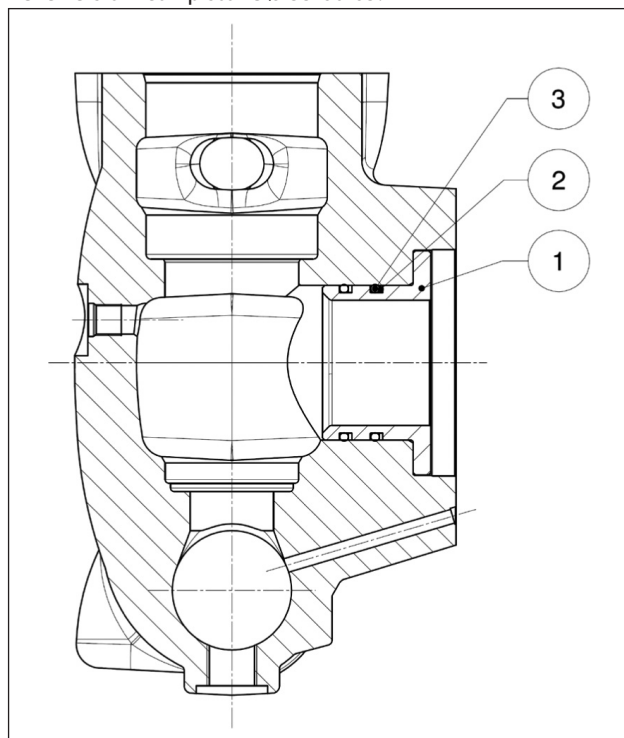

Fig. 148

- n. 1 - Boccola per versioni con pistone $\varnothing 40-45-50$ cod. 74215156 - q.tà 3
- n. 2 - Anello antiestrusore - cod. 90526880 - q.tà 6
- n. 3 - O-ring - cod. 90410200 - q.tà

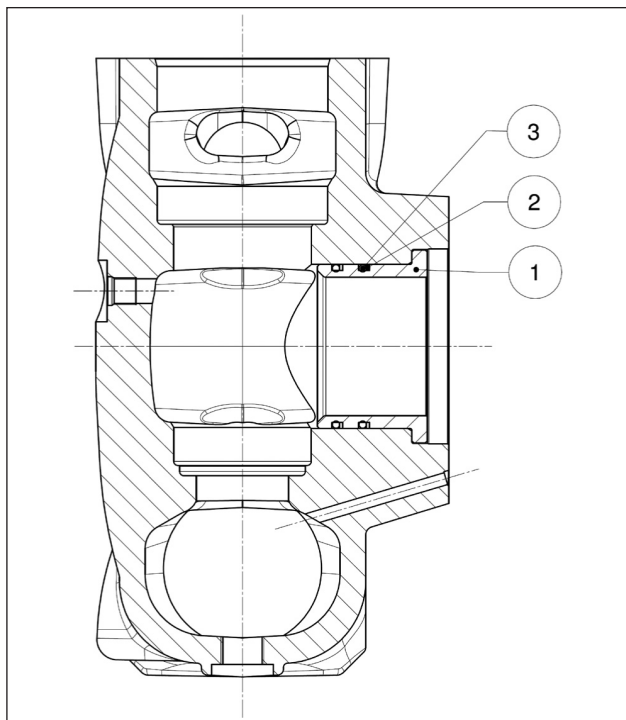

Fig. 149

n. 1 - Boccola versioni con pistone Ø55-60-65 cod.74215056 - q.tà 3

n. 2 - Anello antiestrusore - cod.90528500 - q.tà 6

n. 3 - O-ring - cod. 90412900 - q.tà 6

3 TARATURE SERRAGGIO VITI

Il serraggio delle viti è da eseguirsi esclusivamente con chiave dinamometrica.

Descrizione	Posizione Esploso	Coppia Serraggio Nm
Vite M8x18 coperchio carter	54	20
Tappo G1/2x13 carter	55	40
Vite M8x18 flangia riduttore	54	20
Vite M10x50 coperchio riduttore	70	45
Vite M10x25 fermo corona	65	45
Vite M12x40 scatola riduttore	75	73.5
Vite M12x50 scatola riduttore	64	73.5
Vite M6x14 coperchi super. e infer.	41	10
Vite M12x30 coperchio cuscinetto	90	40
Vite M12x1.25x87 serraggio biella	53	75*
Vite M6x20 guida pistone	49	10
Vite M6x14 coperchio paraolio	41	10
Vite M10x160 fissaggio pistone	27	40
Vite M16x55 coperchio valvole	26	333
Tappo G1/4"x13 testata	13	40
Vite M16x180 testata	25	333**
Dispositivo apertura valvole	2	40

* Raggiungere la coppia di serraggio serrando le viti contemporaneamente

** Serrare le viti partendo dalle 4 viti interne in modo incrociato (vedere Fig. 108), per poi proseguire con le 4 viti esterne, sempre serrando in modo incrociato.

4 ATTREZZI PER LA RIPARAZIONE

La manutenzione della pompa può essere eseguita tramite semplice attrezzi per lo smontaggio e il rimontaggio dei componenti. Sono disponibili i seguenti attrezzi:

Per il montaggio:

Paraolio guida pistone	cod. 27910900
Paraolio pignone	cod. 27515900
	cod. 27548200
O-ring sede valvola mandata versioni con pistone Ø40-45-50	cod. 27516000
O-ring sede valvola mandata versioni con pistone Ø55-60-65	cod. 27516100

Per lo smontaggio:

Sede valvola aspirazione versioni con pistone Ø40-45-50	cod. 27516200
Sede valvola aspirazione versioni con pistone Ø55-60-65	cod. 27516300
Sede valvola mandata	cod. 27516400
Coperchio paraolio	cod. 27516400
	cod. 27516500
Blocco camicia + supporto guarnizioni	cod. 27516600
Coperchio riduttore	cod. 27516700
Albero (bloccaggio bielle)	cod. 27566200

5 SOSTITUZIONE DELLA BOCCOLA DI PIEDE BIELLA

Eseguire il piantaggio a freddo della bronzina e le successive lavorazioni attenendosi alle dimensioni e tolleranze della sottostante Fig. 150.

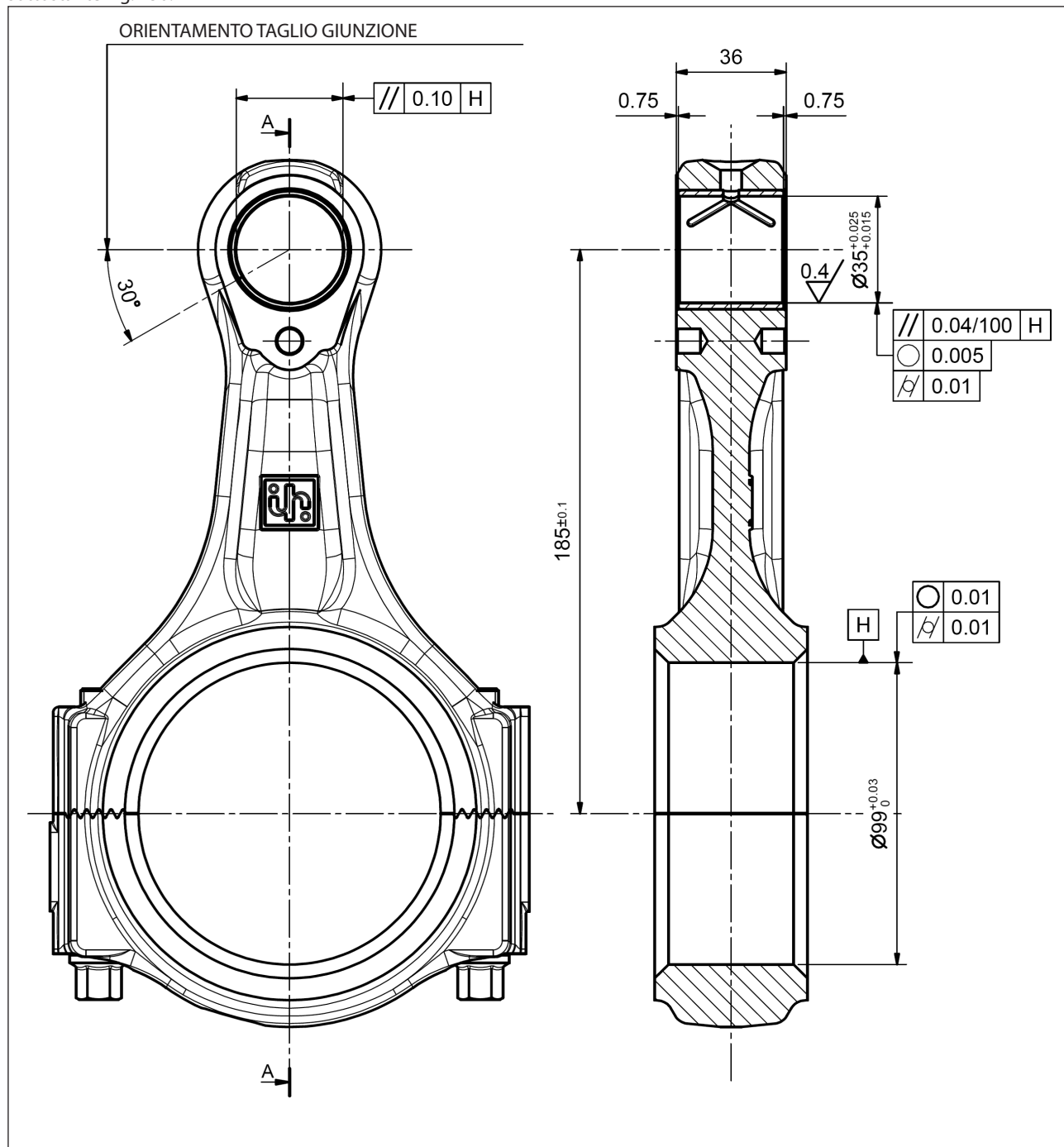

Fig. 150

6 VERSIONI SPECIALI

Di seguito vengono riportate le indicazioni relative alla riparazione delle versioni speciali. Dove non diversamente specificato attenersi a quanto riportato in precedenza per la pompa MK-MKS versione standard.

- Pompe MKC - MKSC: per la riparazione valgono le indicazioni relative alla pompa MK-MKS versione standard.
- Pompe MKR - MKSR: per la riparazione valgono le indicazioni relative alla pompa MK standard escluse le guarnizioni di pressione per le quali occorre seguire i paragrafi successivi.

6.1 SMONTAGGIO DEL GRUPPO PISTONE - SUPPORTI - TENUTE

Il gruppo pistone necessita di una verifica periodica come indicato nella tabella di manutenzione preventiva del **Manuale uso e manutenzione**.

Gli interventi sono limitati al solo controllo visivo dell'eventuale drenaggio dal foro presente sul coperchio inferiore. Qualora si presentassero anomalie / oscillazioni sul manometro di mandata o gocciolamenti dal foro di drenaggio, sarà necessario procedere al controllo e alla eventuale sostituzione del pacco tenute.

Per l'estrazione dei gruppi pistone operare come segue:

Per accedere al gruppo pistone occorre svitare le viti M16x180 e smontare la testata.



Sfilare la testata con il massimo di attenzione per evitare di urtare i pistoni.

Provvedere allo smontaggio dei pistoni svitando le viti di fissaggio (pos. ①, Fig. 151).

Sfilare il pistone dal supporto guarnizioni e controllare che la superficie dello stesso non presenti graffi, segni di usura o di cavitazione.

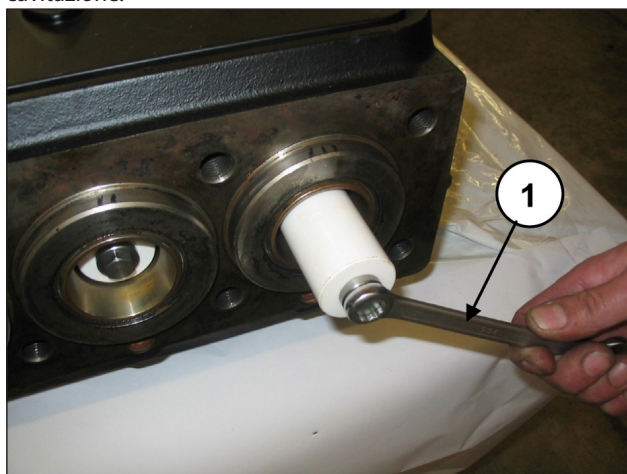

Fig. 151

Rimuovere il coperchio di ispezione superiore svitando le 4 viti di fissaggio (pos. ①, Fig. 152).

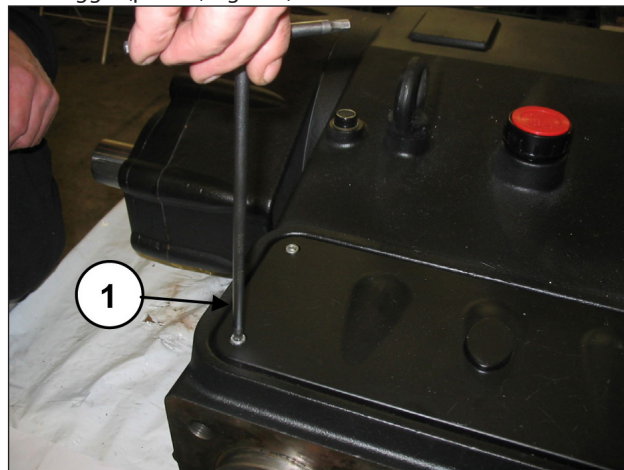

Fig. 152

Ruotare manualmente l'albero in modo da portare i 3 pistoni progressivamente nella posizione di punto morto superiore e inserire l'attrezzo tampone cod. 27516600 tra il guida pistone e il pistone (pos. ①, Fig. 153).

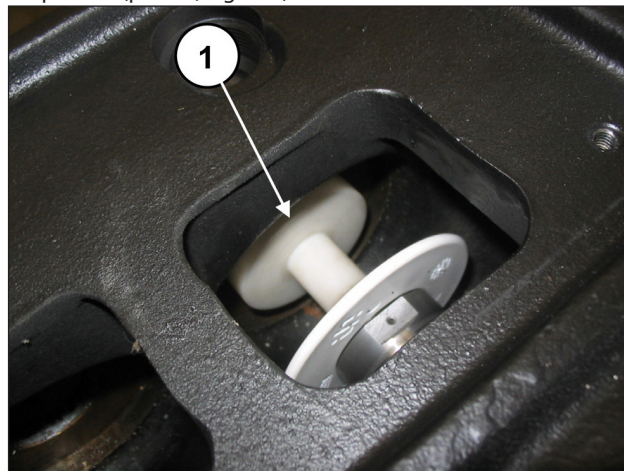

Fig. 153

Ruotando l'albero, fare avanzare il guida pistone in modo che il tampone, avanzando a sua volta, possa espellere il supporto guarnizioni, la molla e tutto il gruppo pistone (pos. ①, Fig. 154).

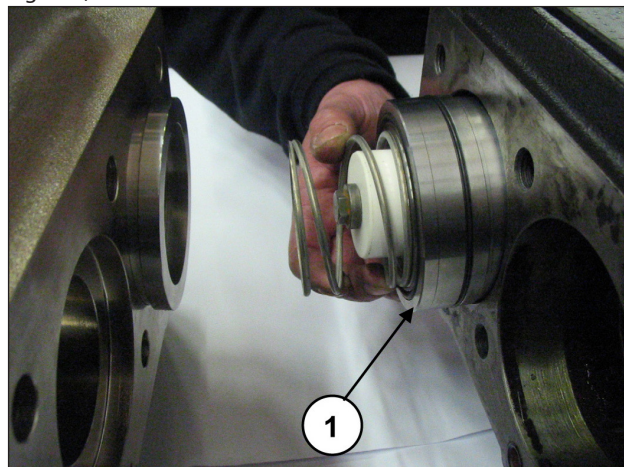

Fig. 154

Estrarre il gruppo supporto guarnizioni e l'attrezzo tampone.

Rimuovere l'O-ring di fondo supporto guarnizione qualora rimanesse all'interno del carter pompa (pos. ①, Fig. 155).

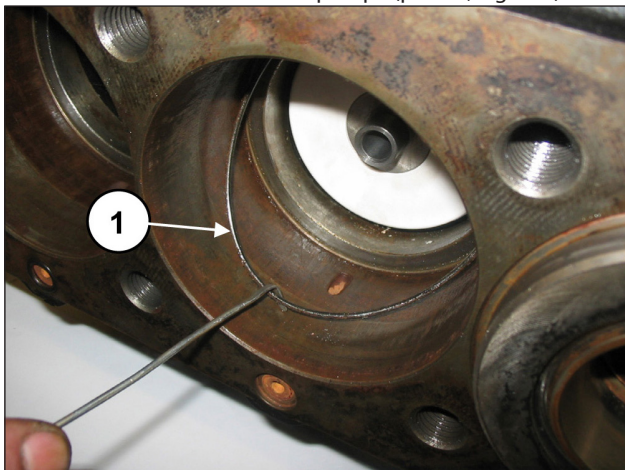

Fig. 155

Sfilare dai guida pistoni gli anelli paraspruzzi (pos. ①, Fig. 156).

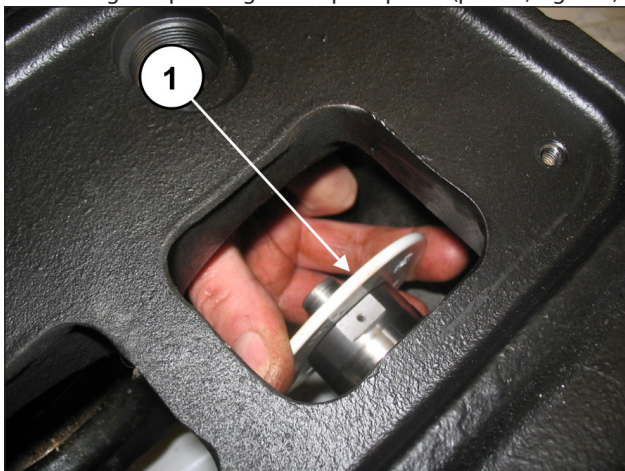

Fig. 156

Qualora fosse necessaria la sostituzione del paraolio del guida pistone occorre smontare il coperchio paraolio procedendo nel seguente modo:

Svitare le due viti di bloccaggio del coperchio paraolio (pos. ①, Fig. 157).

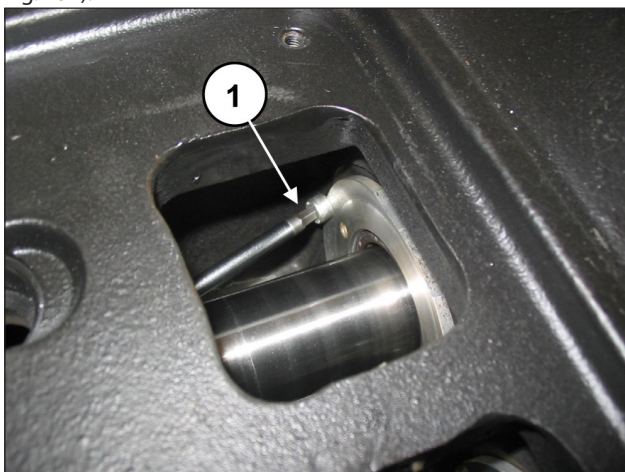

Fig. 157

Posizionare la guida pistone al punto morto inferiore, avvitare l'estrattore cod. 27516400 compreso di adattatore M5 cod. 27516500 negli appositi fori posti sul coperchio (pos. ①, Fig. 158) ed estrarre il coperchio paraolio dal gruppo pompa (pos. ①, Fig. 159).

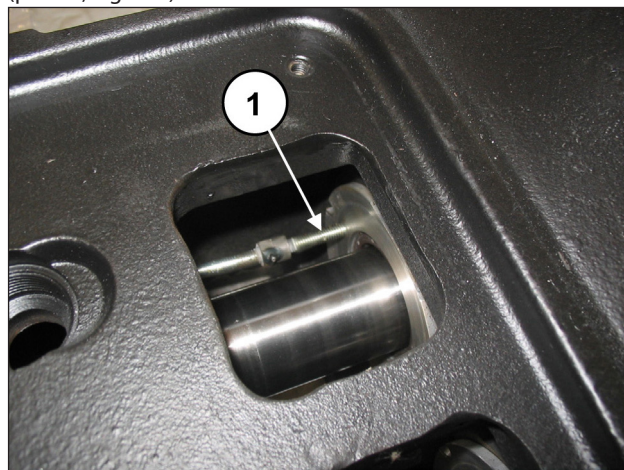

Fig. 158



Fig. 159

Sostituire il paraolio (pos. ①, Fig. 160) e l'O-ring esterno (pos. ②, Fig. 160).

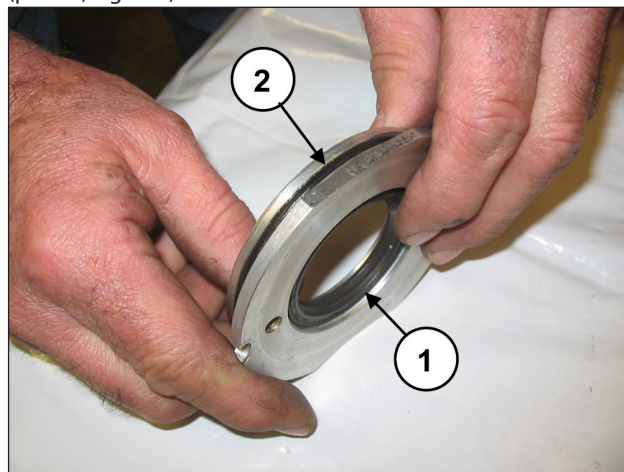

Fig. 160

Separare il supporto guarnizioni dalla camicia, togliere l'anello per molla e l'anello raschiatore (pos. ①②, Fig. 161) per accedere alle guarnizioni di pressione (pos. ①, Fig. 162).

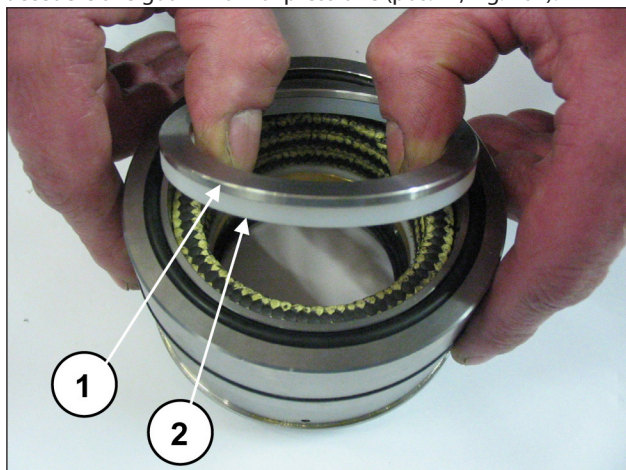

Fig. 161

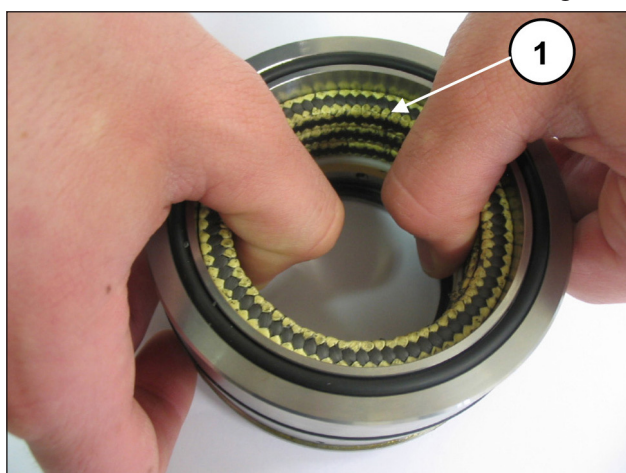

Fig. 162

Per togliere la guarnizione di bassa pressione è necessario utilizzare uno spessore o un attrezzo che non danneggi la sede del supporto guarnizione (pos. ①, Fig. 163).



Fig. 163

6.2 MONTAGGIO DEL GRUPPO PISTONE - SUPPORTI - TENUTE

Procedere al rimontaggio seguendo il procedimento inverso allo smontaggio indicato al par. 6.1.



Sostituire le guarnizioni di pressione inumidendone i labbri con grasso al silicone (senza cospargerle), facendo molta attenzione a non danneggiarle durante l'inserimento nella camicia.



Ad ogni smontaggio le guarnizioni di pressione devono essere sempre sostituite assieme a tutti gli O-ring.

Inserire la guarnizione di bassa pressione nel supporto baderne (pos. ①, Fig. 164) facendo attenzione al senso di montaggio che prevede il labbro di tenuta in avanti (verso la testata) e l'O-ring (pos. ②, Fig. 164).

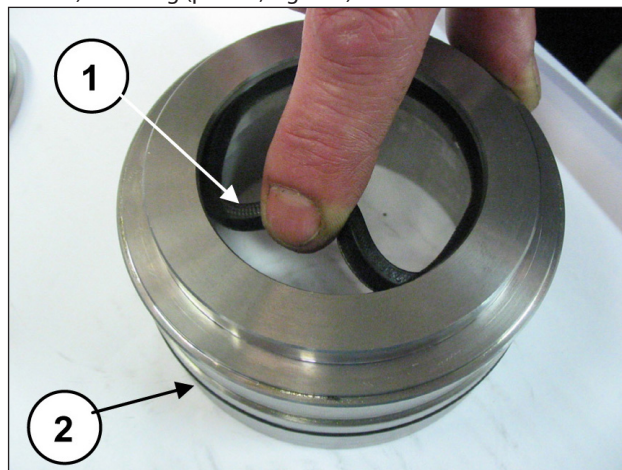

Fig. 164

Montare l'anello di supporto e l'anello antiestrusione (pos. ①②, Fig. 165), le tre baderne ponendo attenzione affinché gli intagli vengano a trovarsi a 120° l'uno dall'altro (pos. ①, Fig. 166), l'anello raschiatore baderne e l'anello per molla (pos. ①②, Fig. 167).

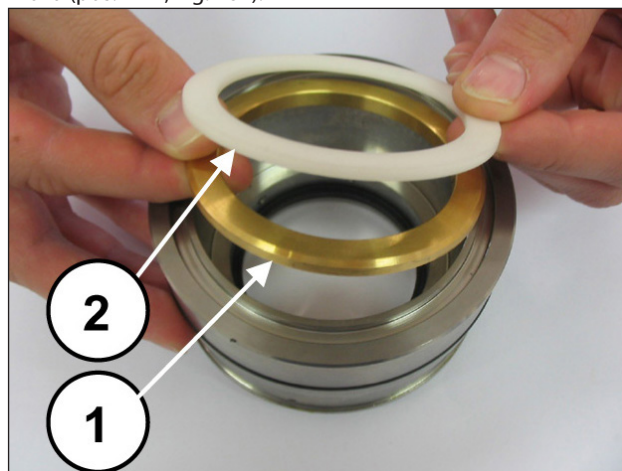

Fig. 165

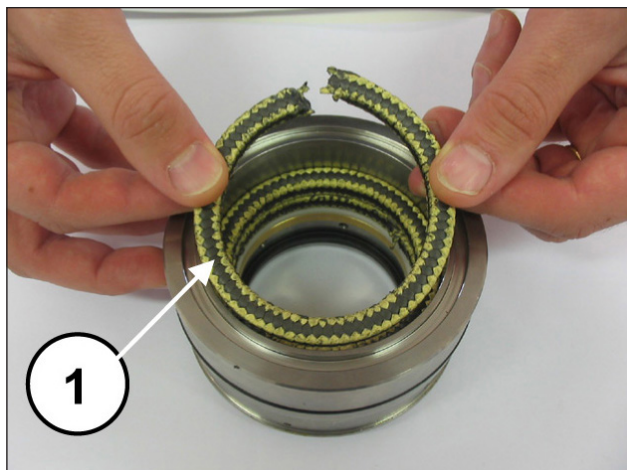

Fig. 166

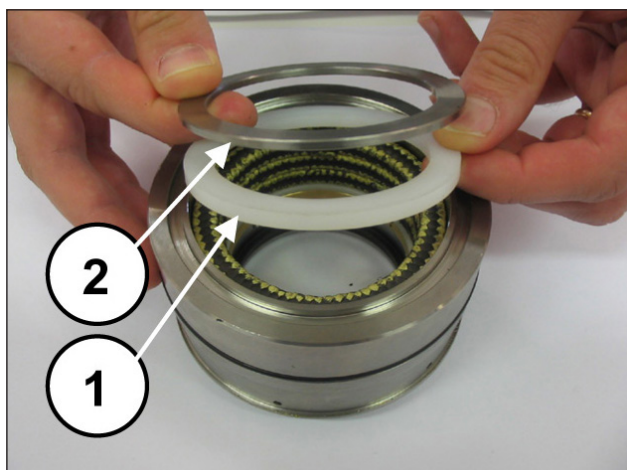

Fig. 167

Montare ora sull'anello di testa baderne l'O-ring (pos. ①, Fig. 168) e posizionarlo nella sede sulla testata.

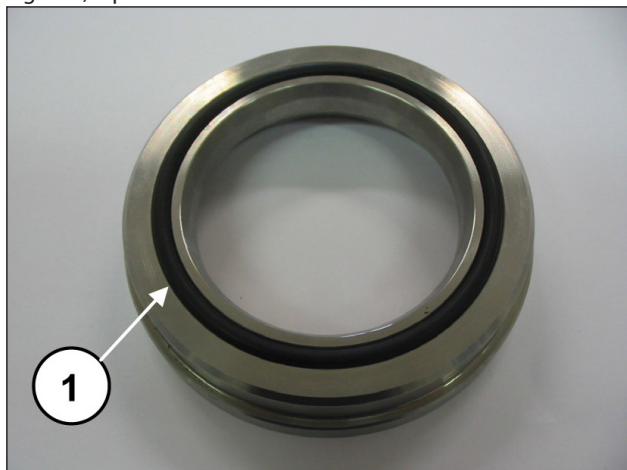

Fig. 168

Montare il paraolio nel coperchio paraolio (pos. ①, Fig. 169) mediante l'utilizzo di un tampone cod. 27910900.

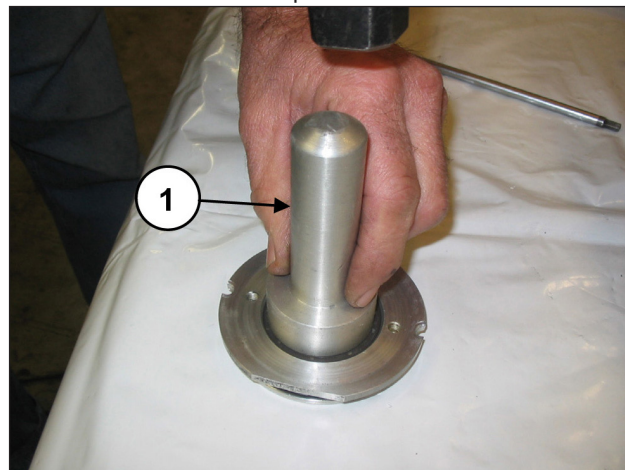

Fig. 169

Posizionare l'O-ring (pos. ①, Fig. 170) nella sede del coperchio paraolio ed inserire il gruppo montato all'interno del carter nell'apposita sede (pos. ①, Fig. 171).

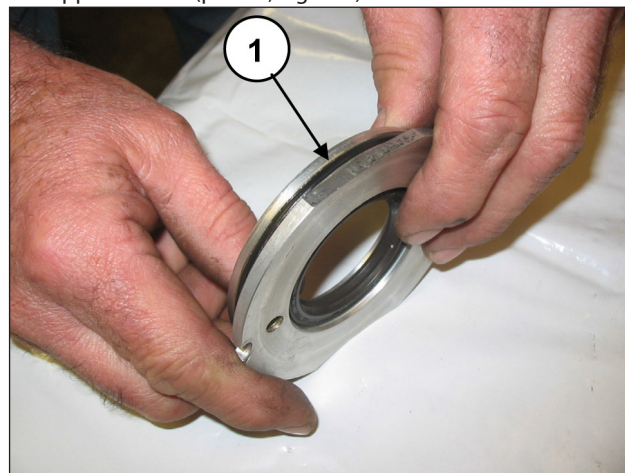

Fig. 170

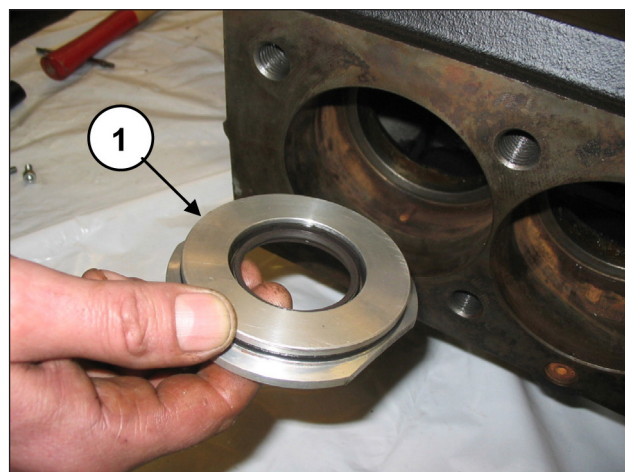

Fig. 171

Assicurarsi che il coperchio entri completamente in sede (pos. ①, Fig. 172) facendo attenzione a non danneggiare il labbro del paraolio. Avvitare i coperchi paraolio mediante 2 viti M6x14 (pos. ①, Fig. 173).

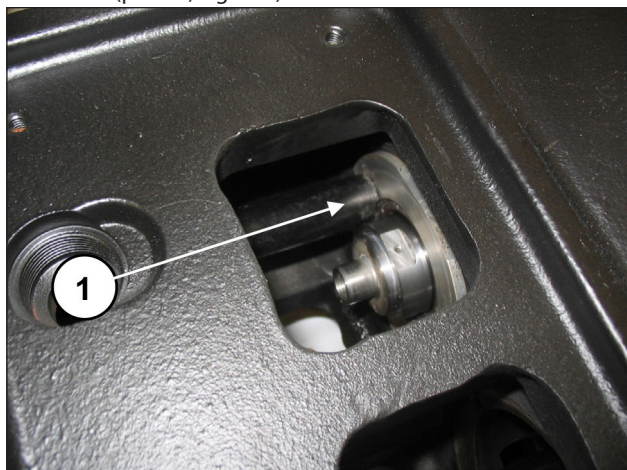

Fig. 172

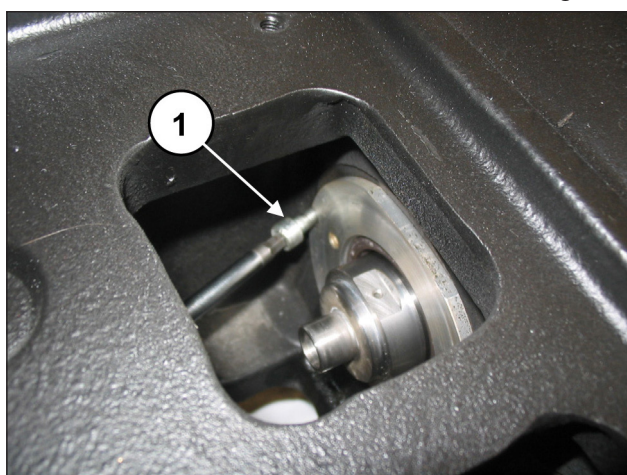

Fig. 173

Tarare le viti con chiave dinamometrica come indicato nel capitolo 3.

Posizionare il paraspruzzi completo di O-ring nell'alloggiamento sul guida pistone (pos. ①, Fig. 174 e Fig. 175).

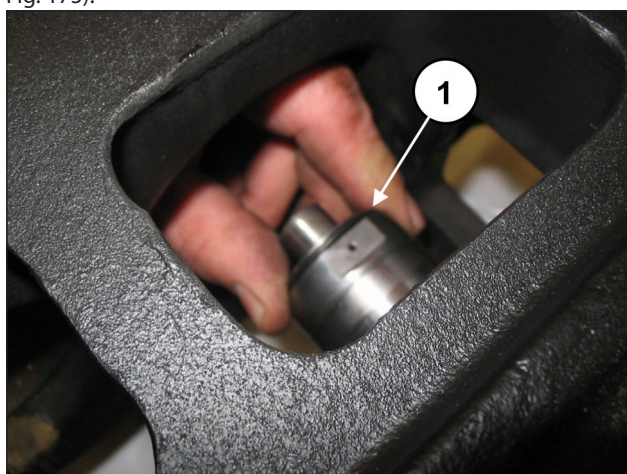

Fig. 174

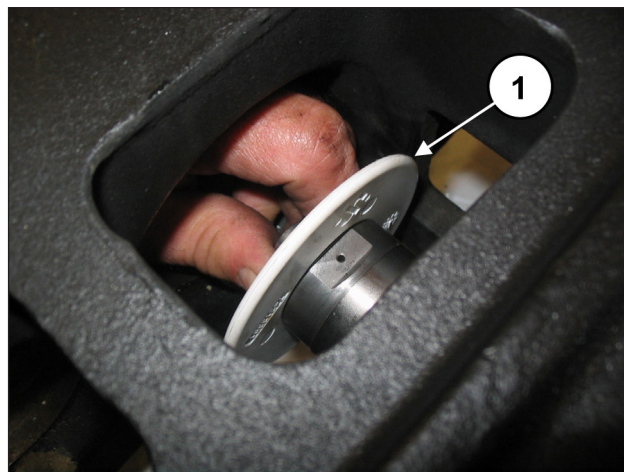

Fig. 175

Inserire la rosetta $\varnothing 10 \times 18 \times 0.9$ nella vite fissaggio pistone (pos. ①, Fig. 176).

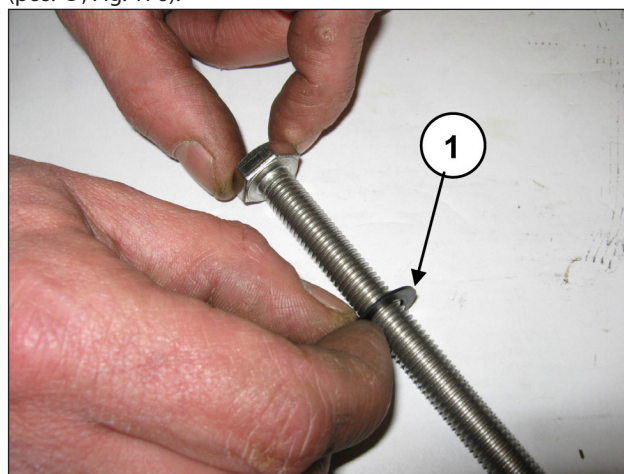

Fig. 176

Montare i pistoni sulle rispettive guide (pos. ①, Fig. 177) e fissarli come da pos. ①, Fig. 178.

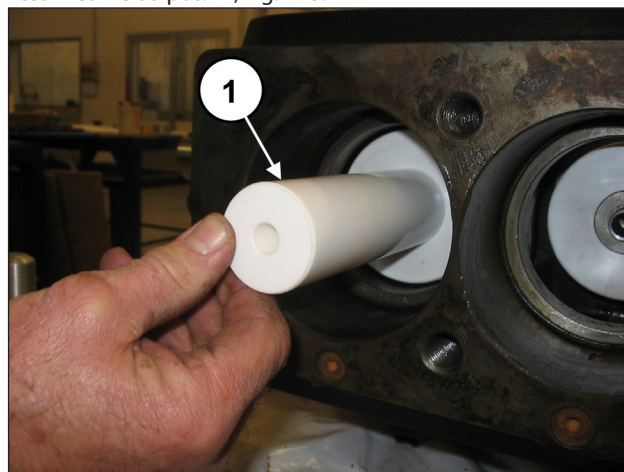

Fig. 177

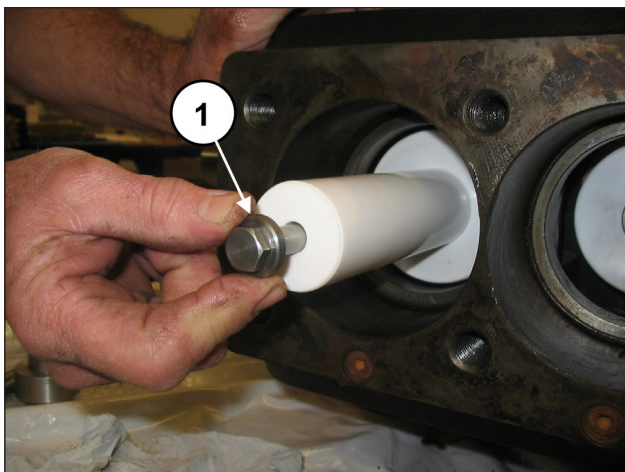

Fig. 178

Tarare le viti con chiave dinamometrica come indicato nel capitolo 3.

Inserire l'O-ring all'interno del carter pompa (pos. ①, Fig. 179) e successivamente il blocco camicia-supporto guarnizione (completo del medesimo O-ring) precedentemente assemblato fino a battuta (pos. ①, Fig. 180).



Fig. 179

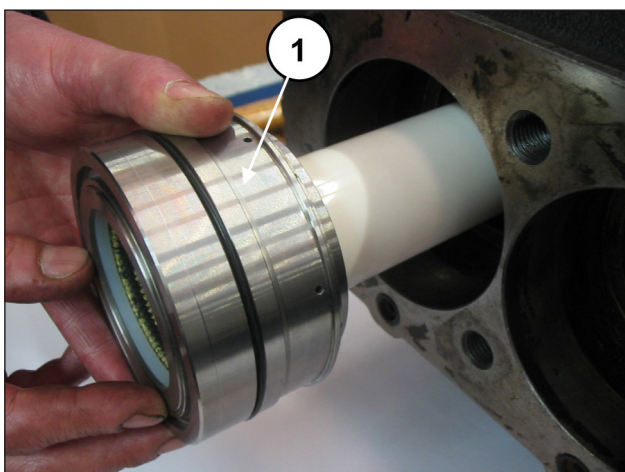

Fig. 180

Assicurarsi che il blocco camicia-supporto arrivi a posizionarsi correttamente fino a fondo sede (pos. ①, Fig. 181); montare ora l'O-ring frontale della camicia e la molla (pos. ①②, Fig. 182).

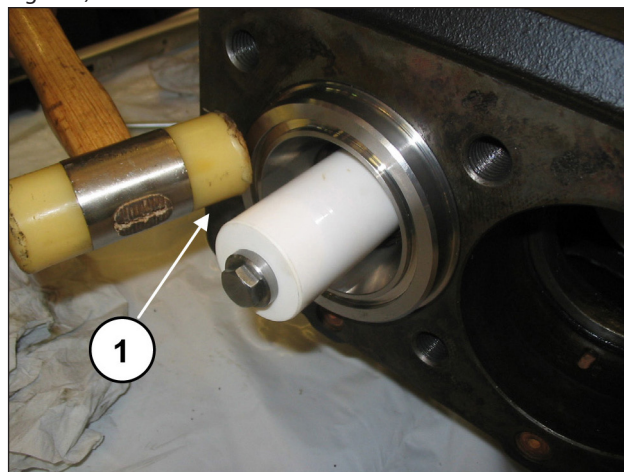

Fig. 181

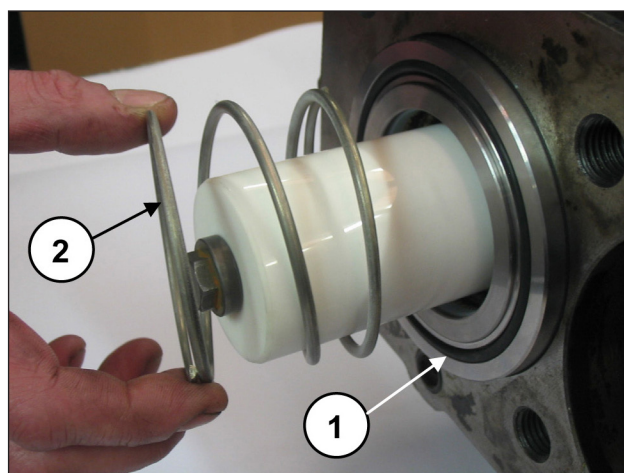

Fig. 182

Montare l'O-ring del foro di ricircolo (pos. ①, Fig. 183).

Facilitare il mantenimento in sede degli O-ring con leggera applicazione di grasso.

La Fig. 184 mostra il susseguente montaggio della testata.

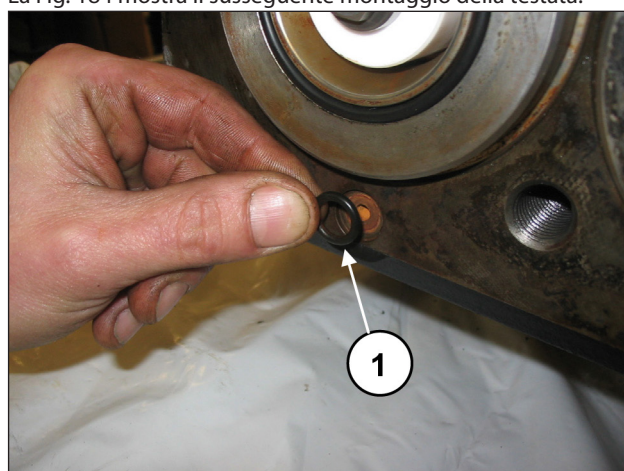

Fig. 183

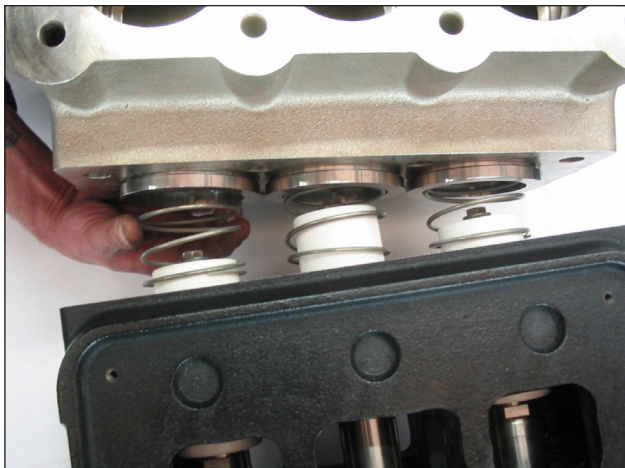

Fig. 184

Sui coperchi ispezione inserire l'O-ring (pos. ①, Fig. 185) e montare i coperchi mediante l'utilizzo di 4+4 viti M6x14 (pos. ①, Fig. 186).

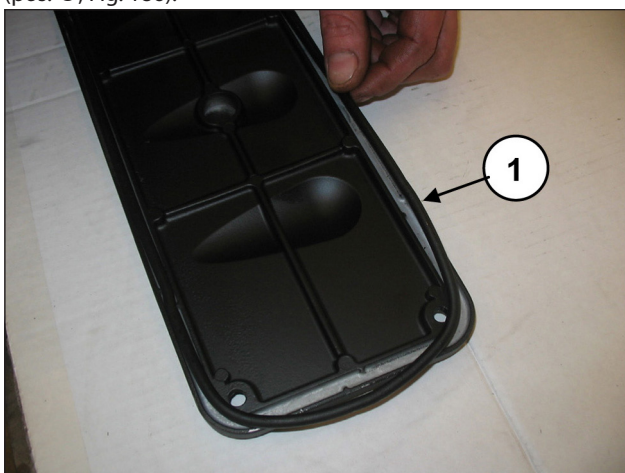

Fig. 185

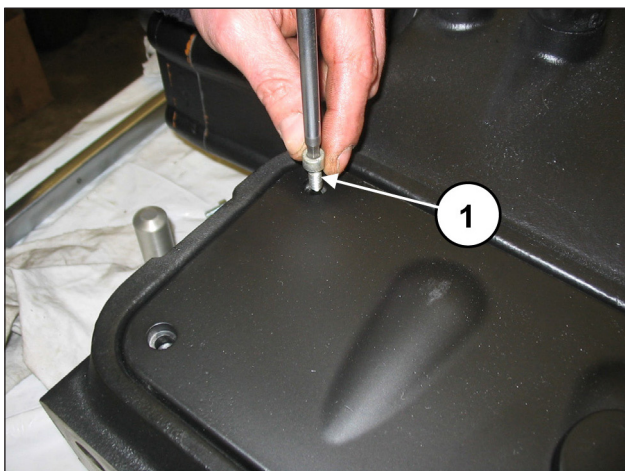

Fig. 186

Tarare le viti con chiave dinamometrica come indicato nel capitolo 3.

Table of Contents

1	INTRODUCTION	41
1.1	DESCRIPTION OF SYMBOLS.....	41
2	REPAIR GUIDELINES	41
2.1	REPAIRING MECHANICAL PARTS.....	41
2.1.1	<i>Disassembly of mechanical parts</i>	41
2.1.2	<i>Assembly of mechanical parts</i>	48
2.1.3	<i>Classes of increase</i>	55
2.2	REPAIRING HYDRAULIC PARTS.....	55
2.2.1	<i>Dismantling the head – valve units</i>	55
2.2.2	<i>Assembling the head – valve units</i>	57
2.2.3	<i>Disassembly of the piston unit – supports – seals</i>	61
2.2.4	<i>Assembling the piston unit – supports – seals</i>	63
2.2.5	<i>Recovering the heads</i>	67
3	SCREW TIGHTENING CALIBRATION	68
4	REPAIR TOOLS	69
5	REPLACING THE CON-ROD FOOT BUSH	70
6	SPECIAL VERSIONS	71
6.1	DISASSEMBLY OF THE PISTON UNIT – SUPPORTS – SEALS	71
6.2	ASSEMBLING THE PISTON UNIT – SUPPORTS – SEALS.....	73

1 INTRODUCTION

This manual describes the instructions for repairing MK series pumps and should be carefully read and understood before any intervention on the pump.

Proper pump operation and duration depend on the correct use and maintenance.

Interpump Group disclaims any responsibility for damage caused by negligence or failure to observe the standards described in this manual.

1.1 DESCRIPTION OF SYMBOLS

Read the contents of this manual carefully before each operation.



Warning Sign



Read the contents of this manual carefully before each operation.



Danger Sign

Wear protective goggles.



Danger Sign

Put on protective gloves before each operation.

2 REPAIR GUIDELINES



2.1 REPAIRING MECHANICAL PARTS

Mechanical parts must be repaired after the oil has been removed from the casing.

To remove oil, you must remove the oil filler cap pos. ①, Fig. 1 and then the drain plug pos. ②, Fig. 1.

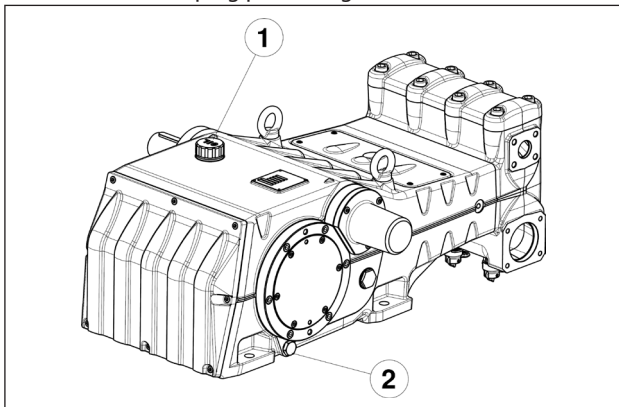

Fig. 1



The used oil must be placed in a suitable container and disposed of in special centres. It absolutely should not be discarded into the environment.

2.1.1 Disassembly of mechanical parts

The correct sequence is as follows:

Drain the pump of oil completely and then remove the tab from the shaft (pos. ①, Fig. 2).

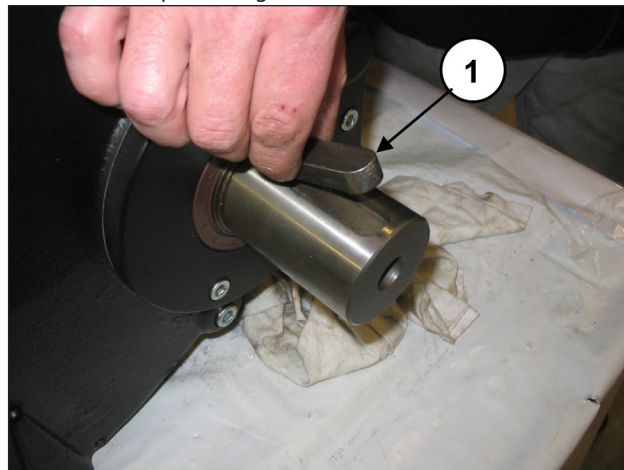

Fig. 2

Unscrew the reduction gear flange fixing screws (pos. ①, Fig. 3) and remove the flange from the shaft.

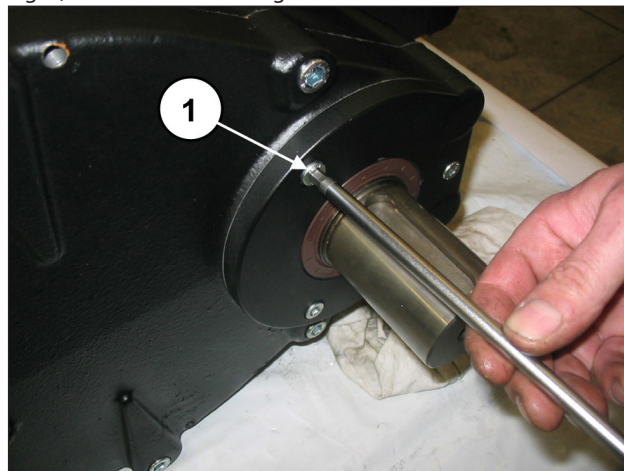

Fig. 3

Unscrew the bearing cover fixing screws from the opposite side (pos. ①, Fig. 4) and remove it.

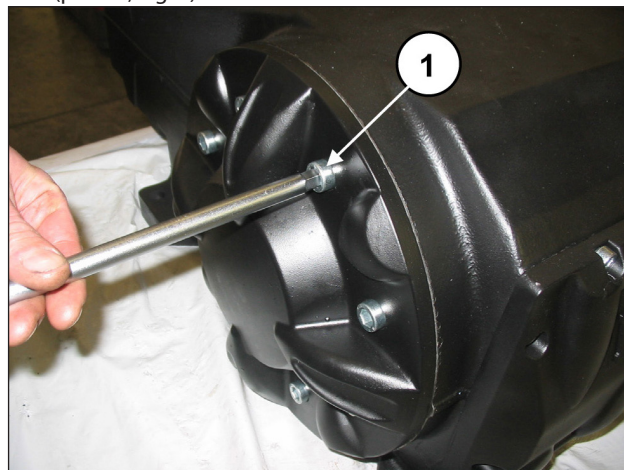

Fig. 4

Now remove the casing cover by unscrewing the screws (pos. ①, Fig. 5).

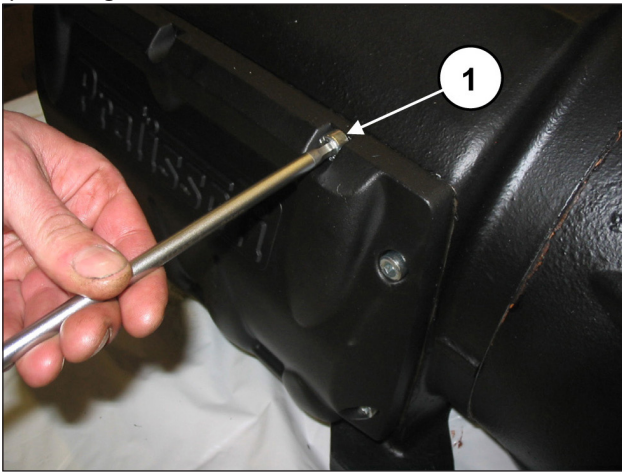

Fig. 5

Unscrew the reduction gear cover fixing screws (pos. ①, Fig. 6).

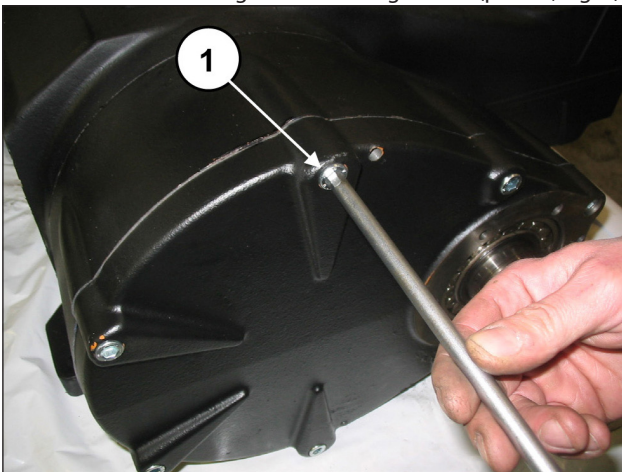

Fig. 6

Position the 3 grub screws or M8 threaded screws (pos. ①, Fig. 7) with the function of extractors in the holes and two sufficiently long M10 screws with the function of supporting the cover (pos. ②, Fig. 7).

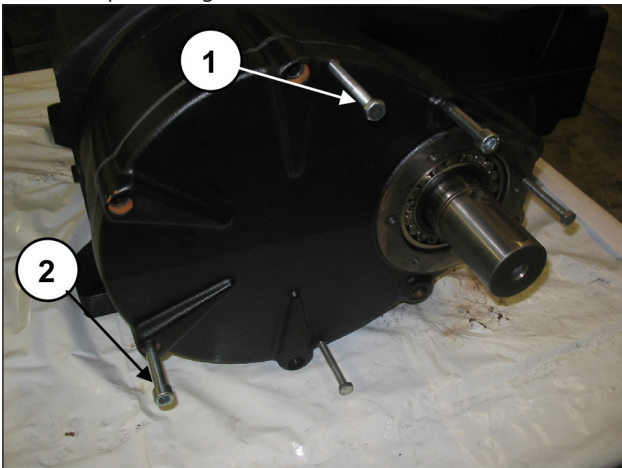

Fig. 7

Screw in the 3 grub screws (pos. ①, Fig. 8) with the function of extractors and at the same time, using the special tool (code 27516700), beat on it so that the bearing remains on the pinion during cover removal (pos. ①, Fig. 9).

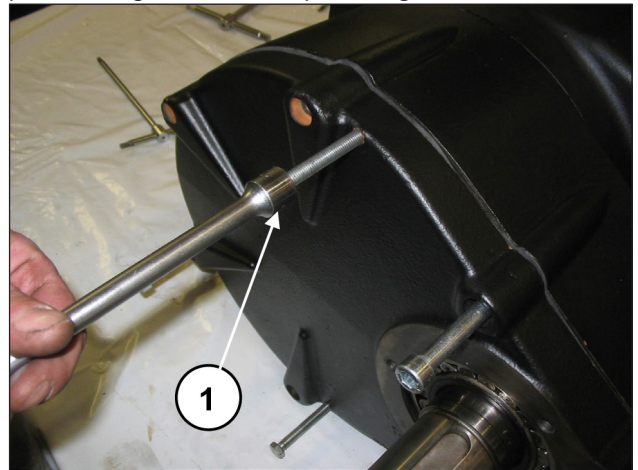

Fig. 8

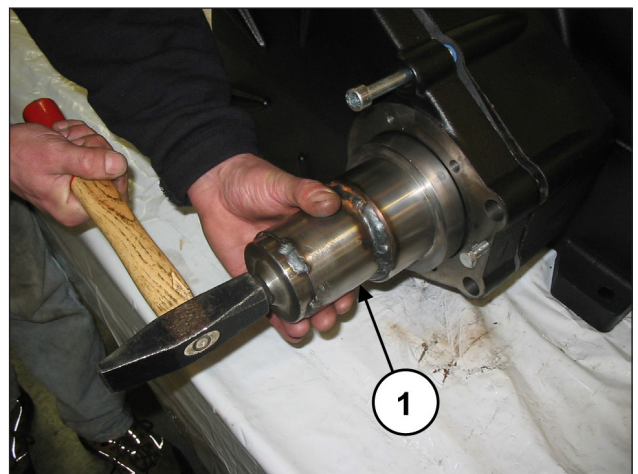

Fig. 9

On completing this process, remove the reduction gear cover and then extract the bearing from the pinion. Unscrew the screws holding in the ring gear (pos. ①, Fig. 10) and remove it (pos. ①, Fig. 11).

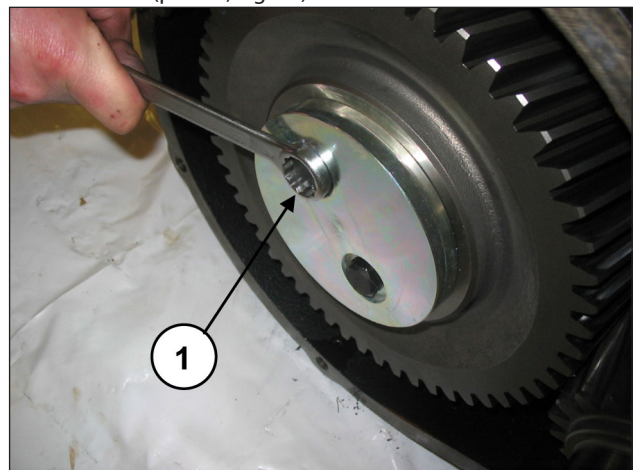

Fig. 10

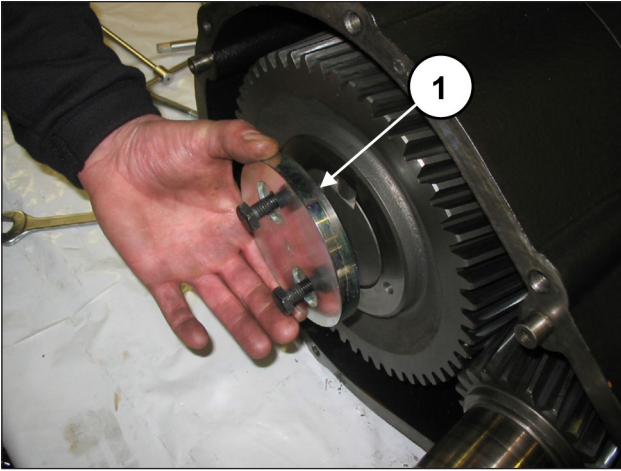

Fig. 11

Remove the ring gear (pos. ①, Fig. 12). If necessary, it is possible to use an extractor hammer to be applied on the 2 M8 holes (pos. ②, Fig. 12).

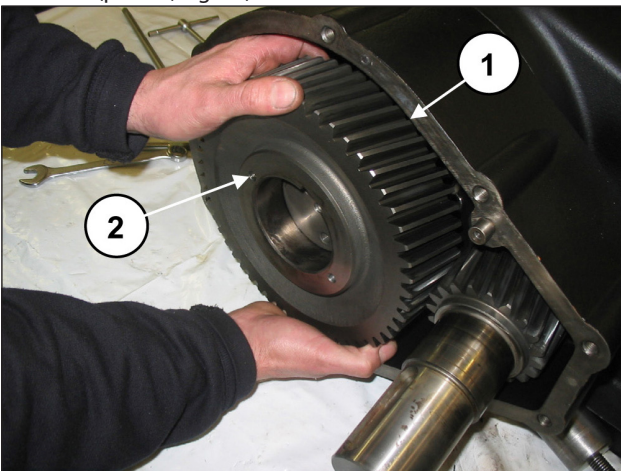

Fig. 12

Remove the tab from the shaft (pos. ①, Fig. 13).

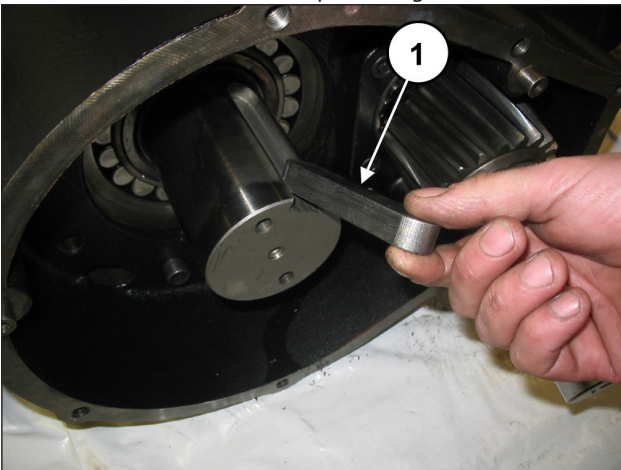

Fig. 13

Remove the pinion using an extractor hammer to be applied on the M14 hole (pos. ①, Fig. 14).

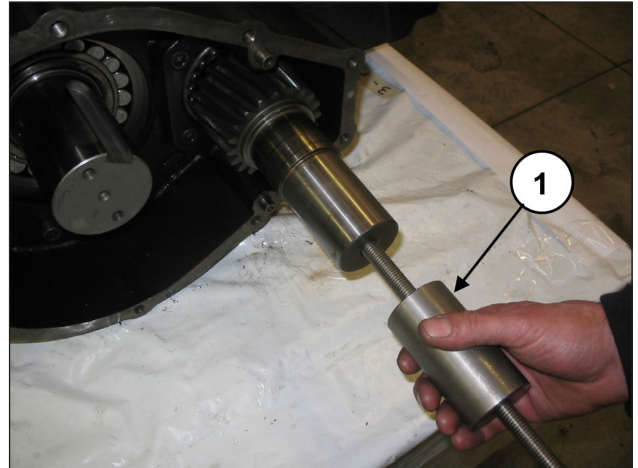

Fig. 14

Raise the tab of the safety washer (pos. ①, Fig. 15).

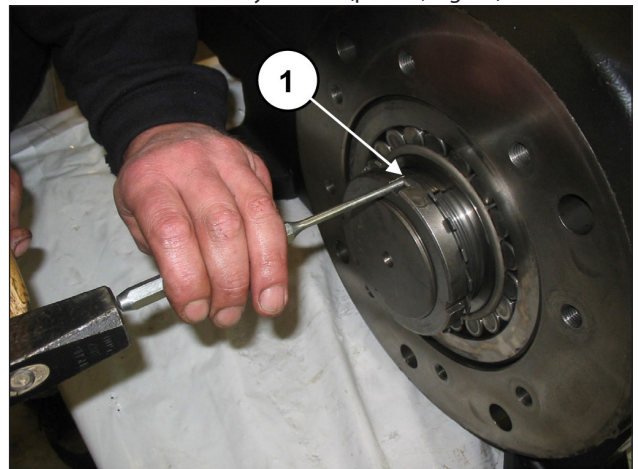

Fig. 15

Insert a shim under the con-rod to block shaft rotation (pos. ①, Fig. 16).

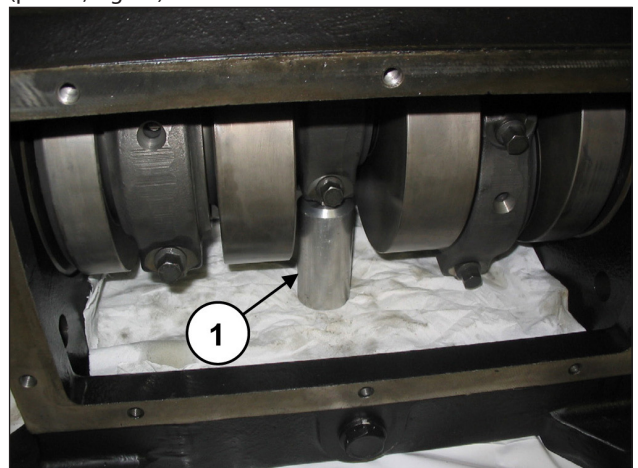

Fig. 16

Using a suitable wrench, unscrew the locking ring nut (pos. ①, Fig. 17) then remove the ring nut and the safety washer (pos. ①, Fig. 18).

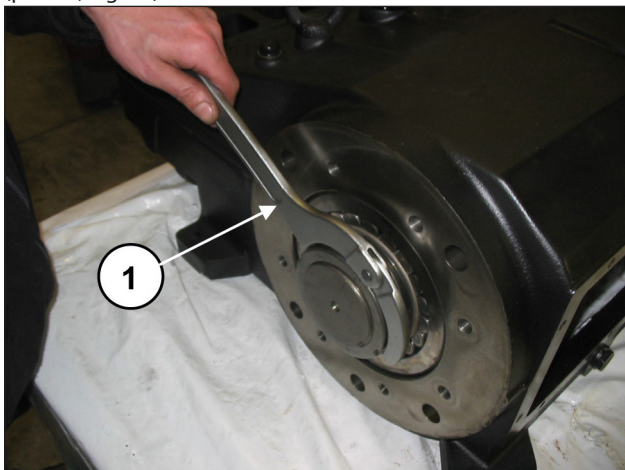

Fig. 17

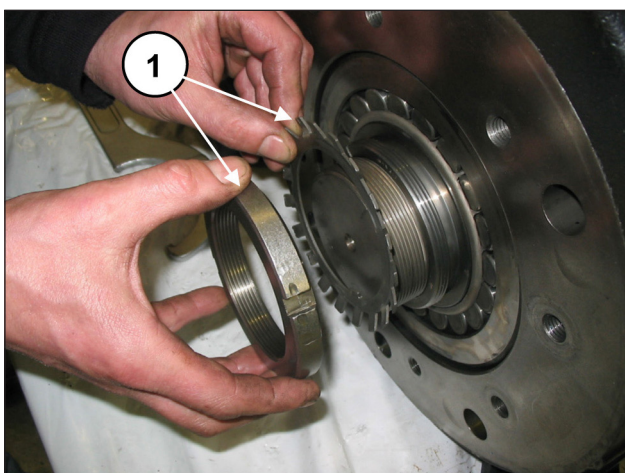

Fig. 18

Screw a ring nut type SKF KM19 onto the pressure bush (pos. ①, Fig. 19) then, using an appropriate wrench, loosen the bush (pos. ①, Fig. 20).

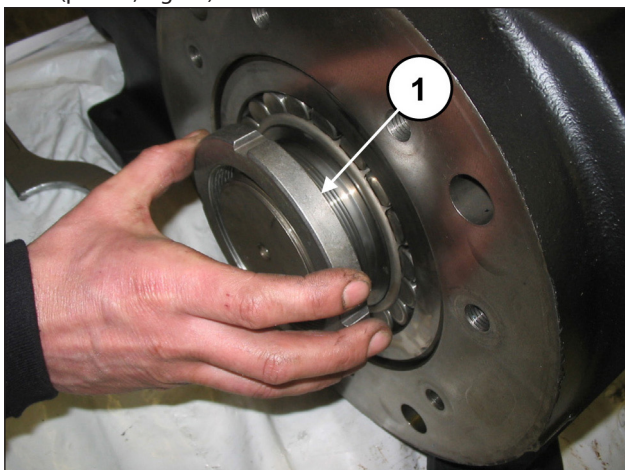

Fig. 19

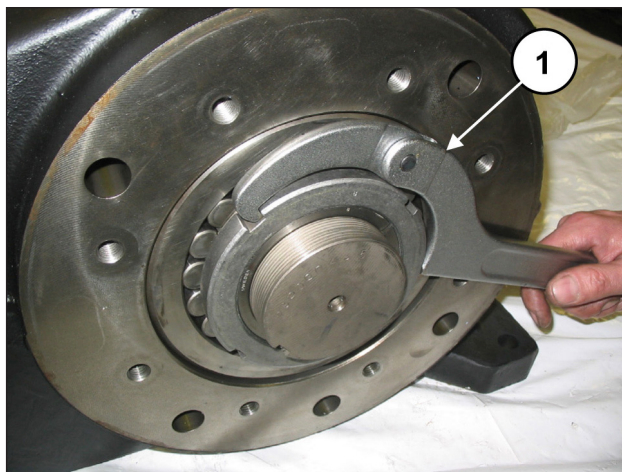

Fig. 20

On the opposite side, unscrew the reduction gear box fixing screws (pos. ①, Fig. 21), then remove it (pos. ①, Fig. 22).

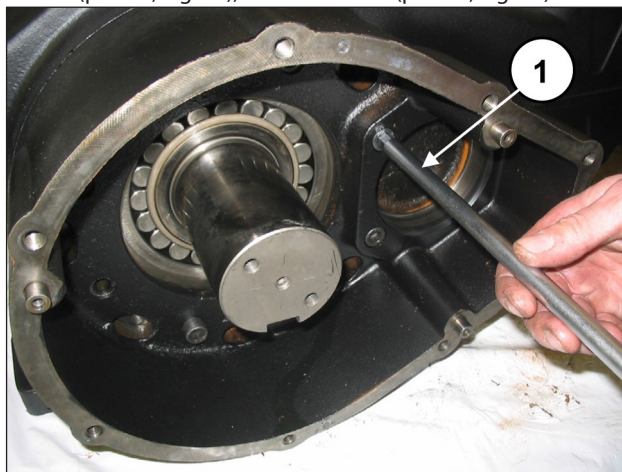

Fig. 21

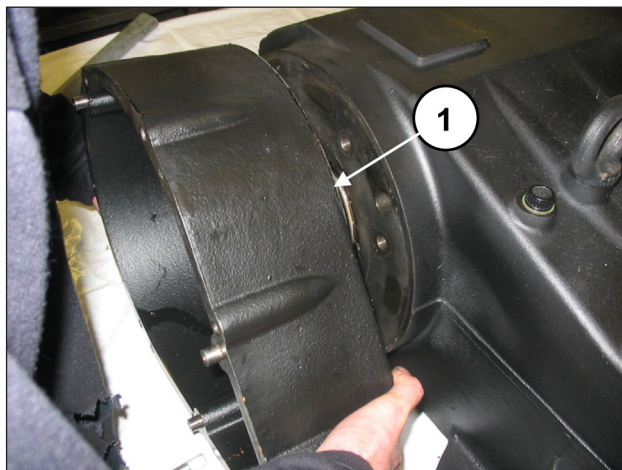

Fig. 22

Unscrew the con-rod screws (pos. ①, Fig. 23).

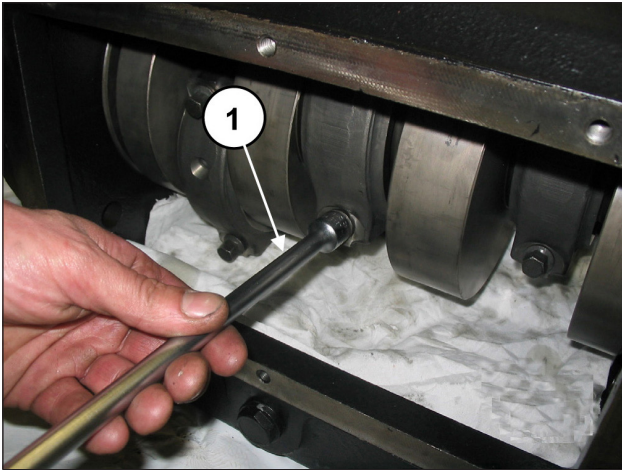

Fig. 23

Remove the con-rod caps with the semi-bearings, taking special care of the disassembly sequence during disassembly.



The con-rod caps and their relative half supports must be reassembled in exactly the same order and coupling with which they were disassembled.

To avoid possible errors, caps and half supports have been numbered on one side (pos. ①, Fig. 24).

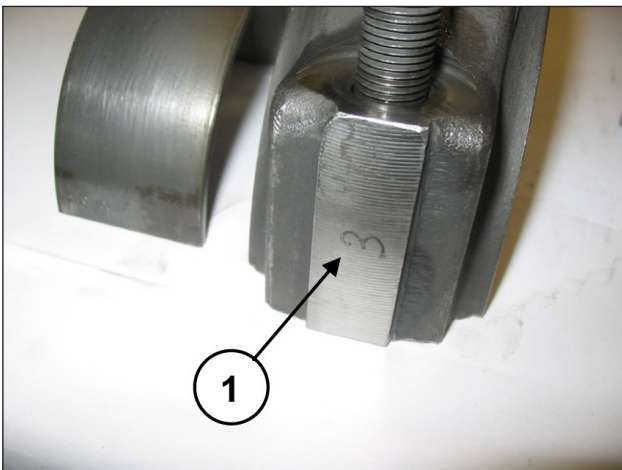

Fig. 24

Advance the half supports in the direction of the hydraulic part to allow the shaft to come out. To facilitate this operation, use special tool (code 27566200), (pos. ①, Fig. 25).

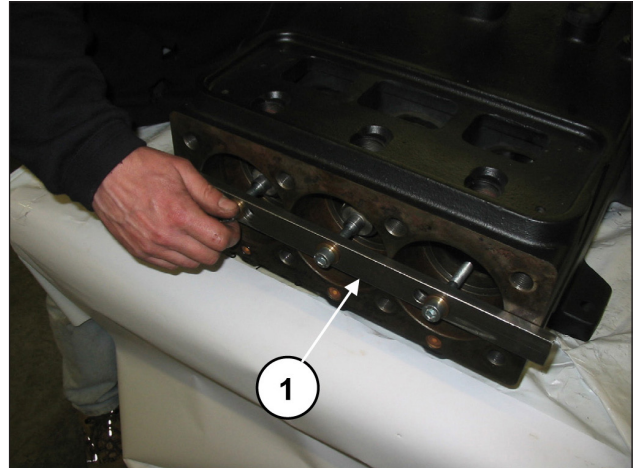

Fig. 25

Remove the pressure bush (pos. ①, Fig. 26).

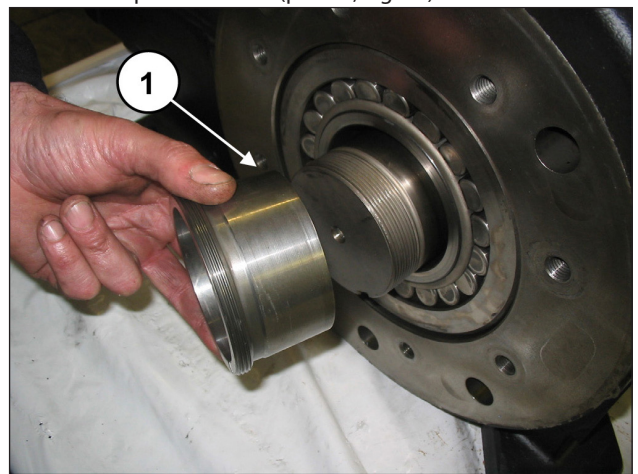

Fig. 26

Remove the three upper half-bearings of the half supports (pos. ①, Fig. 27).

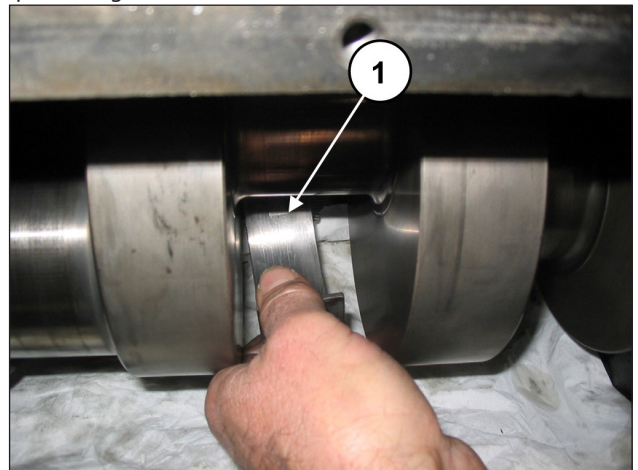

Fig. 27

Extract the bend shaft with the aid of an extractor hammer from the PTO side (pos. ①, Fig. 28).

Extract the shaft and bearing (pos. ①, Fig. 29).

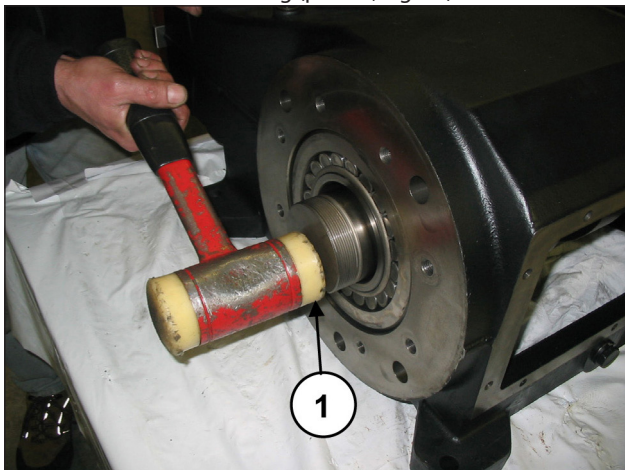

Fig. 28

Unscrew the screws with tool code 27566200 to unlock the con-rods (pos. ①, Fig. 31) and then extract the con-rod-piston guide units from the back casing opening (pos. ①, Fig. 32).

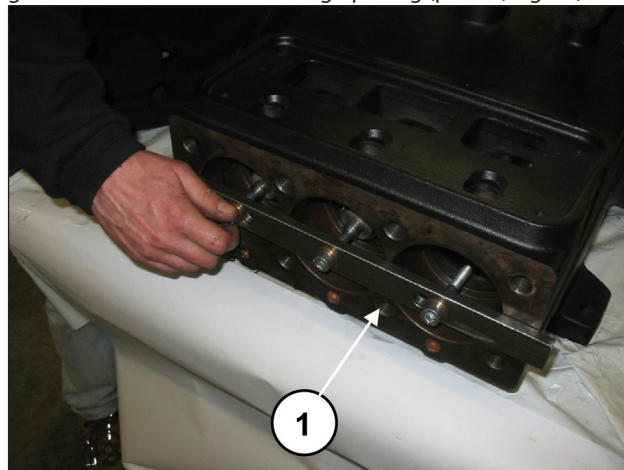

Fig. 31

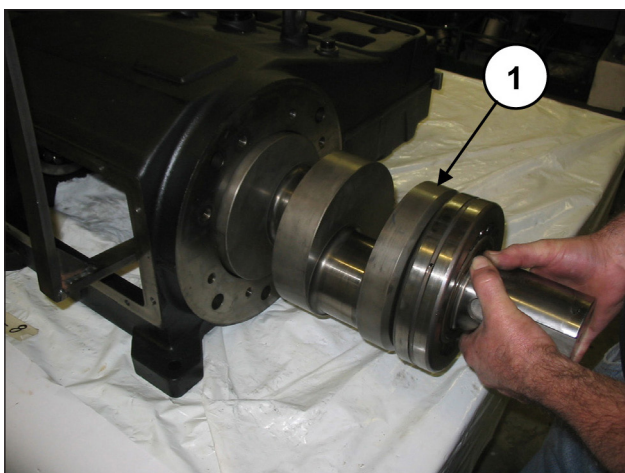

Fig. 29

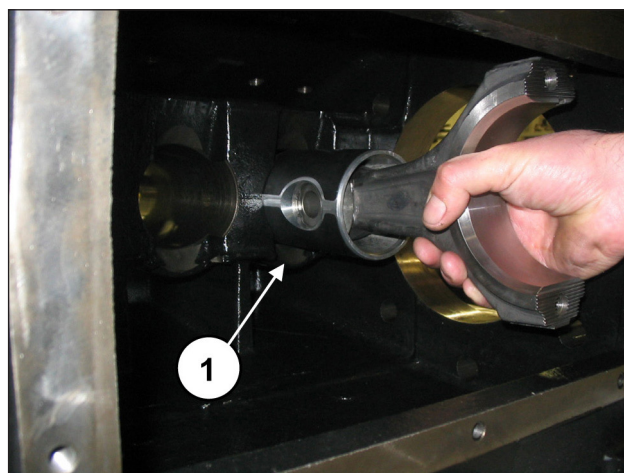

Fig. 32

From the opposite side, extract the bearing (pos. ①, Fig. 30).



Fig. 30

In the event that it is necessary to replace one or more con-rods or piston guides, operate as follows:

Couple the half supports to the previously disassembled caps, referring to the numbering (pos. ①, Fig. 33).

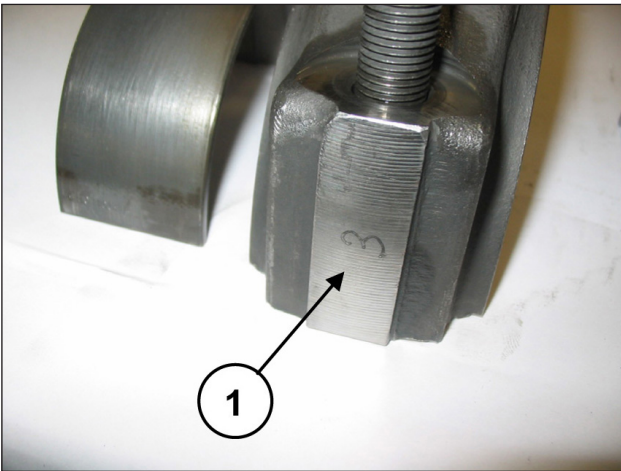

Fig. 33

Remove the two spindle locking Seeger rings using a special tool (pos. ①, Fig. 34).

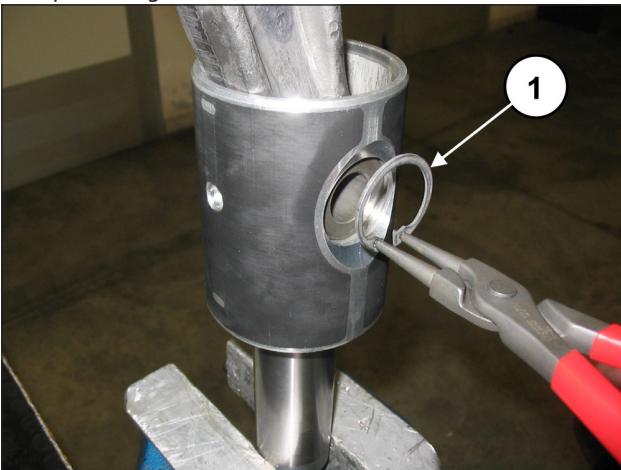

Fig. 34

Remove the spindle (pos. ①, Fig. 35) and extract the con-rod (pos. ①, Fig. 36).

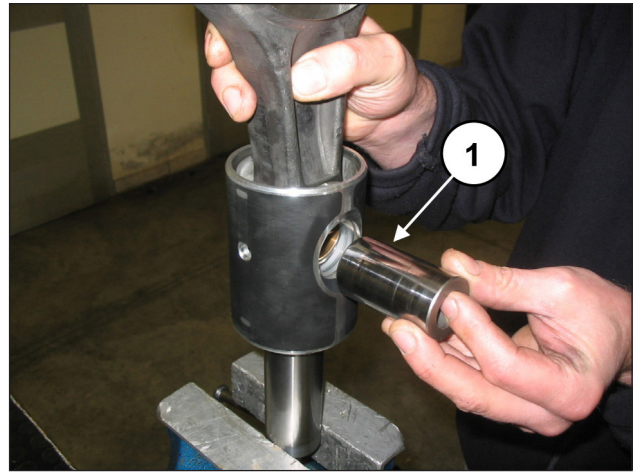

Fig. 35

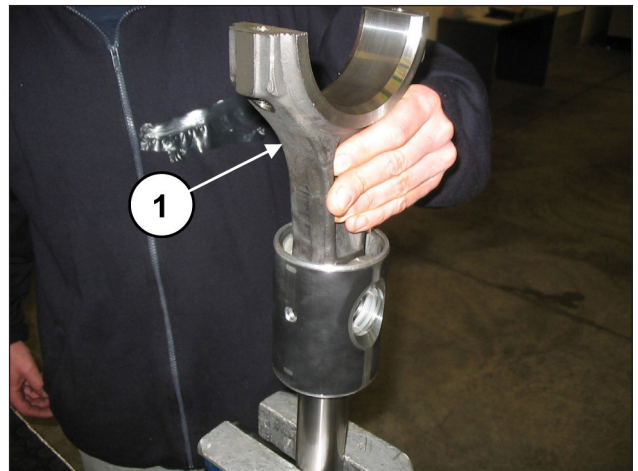

Fig. 36

To separate the rod from the piston guide, unscrew the hexagonal head M6 screws with a special wrench (pos. ①, Fig. 37).

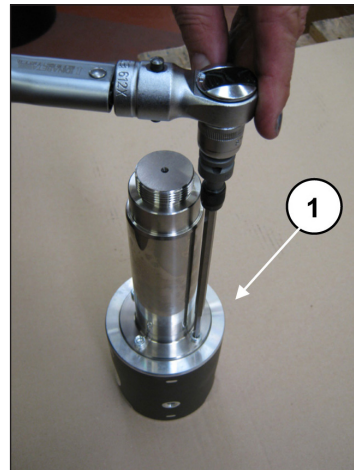

Fig. 37

2.1.2 Assembly of mechanical parts

Proceed with assembly following the reverse order indicated in par. 2.1.1.

The correct sequence is as follows:

Assemble the red to the piston guide.

Insert the piston guide rod into its seat on the piston guide (pos. ①, Fig. 38) and join the rod to the piston guide by means of the 4 M6x20 screws (pos. ①, Fig. 39).



Fig. 38



Fig. 39

Lock the piston guide in a vice with the aid of a special tool and calibrate the screws with a torque wrench (pos. ①, Fig. 40) as indicated in chapter 3.

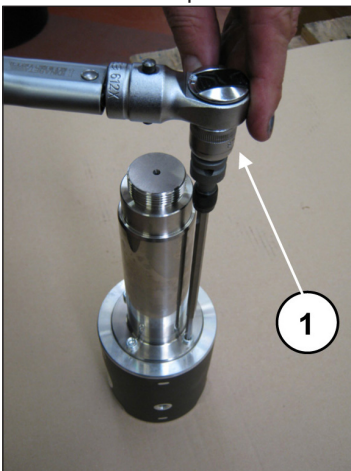

Fig. 40

Insert the con-rod in the piston guide (pos. ①, Fig. 36) and then insert the spindle (pos. ①, Fig. 35). Fit on the two Seeger rings with the special tool (pos. ①, Fig. 34).



Assembly has been carried out properly if the con-rod foot, piston guide and spindle rotate freely

Separate the caps from the half supports. Proper coupling can be verified by the numbering on the side (pos. ①, Fig. 33). After having checked casing cleaning, proceed with assembly of half support-piston guide unit inside casing rods (pos. ①, Fig. 32).



Insertion of the half support-piston guide unit in the casing must be made with the half bearings set in the direction in which numbers are visible from above.

Block the three units with the use of special tool code 27566200 (pos. ①, Fig. 31).

Pre-assemble the bearing, PTO side, on the shaft to the end stroke (pos. ①, Fig. 41) and mount the bearing on the opposite side on the casing (pos. ①, Fig. 42).



The bearing in Fig. 42 has a tapered internal ring. Check that the taper goes from the outside inwards to allow inserting the bush.

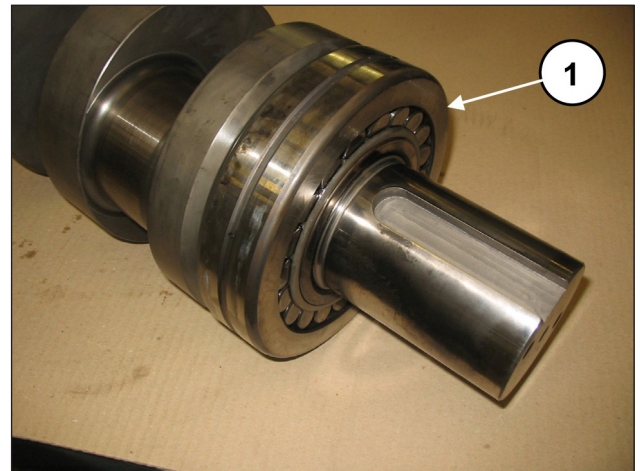

Fig. 41

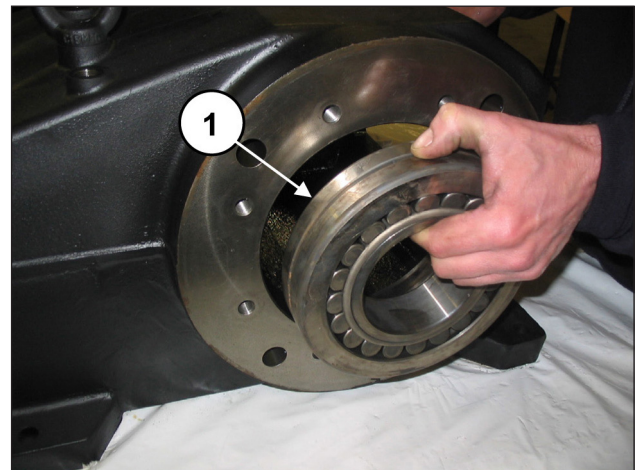

Fig. 42

Insert the shaft (pos. ①, Fig. 29) until the pre-assembled bearing is flush with the edge of the casing (pos. ①, Fig. 43).

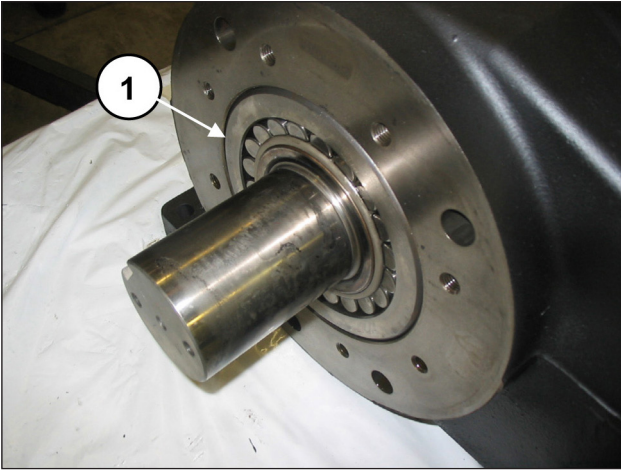

Fig. 43

Insert the pressure bush manually to keep the shaft aligned (pos. ①, Fig. 44).

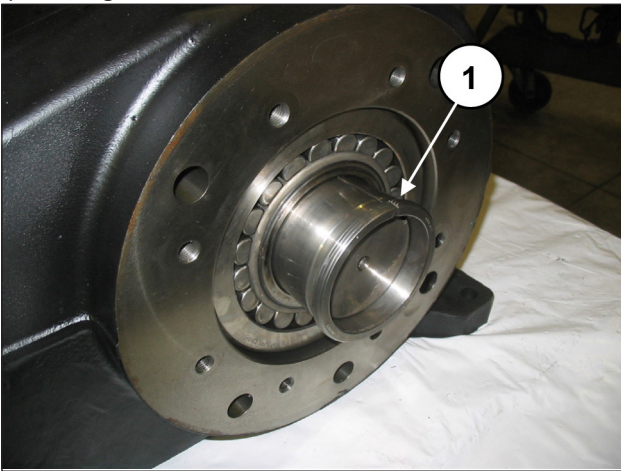

Fig. 44

Mount the reduction gear box (pos. ①, Fig. 45) and the gasket (pos. ②, Fig. 45) using the 6 M12x40 screws (pos. ①, Fig. 46), the 2 M12x50 screws (pos. ①, Fig. 47) and the Grower washers Ø12 (pos. ②, Fig. 46 and Fig. 47).

Calibrate the screws with a torque wrench (pos. ①, Fig. 48) as indicated in chapter 3.

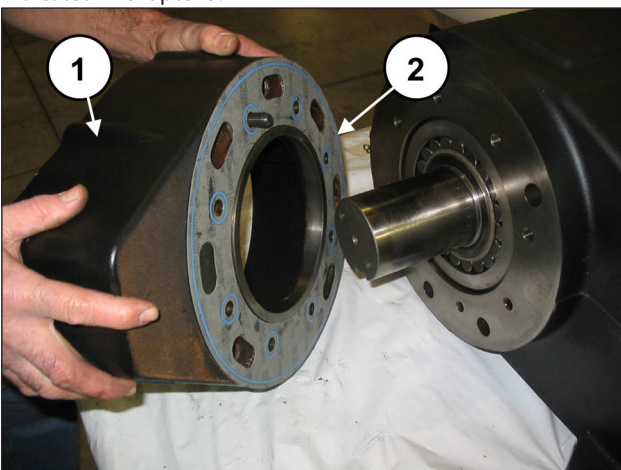

Fig. 45

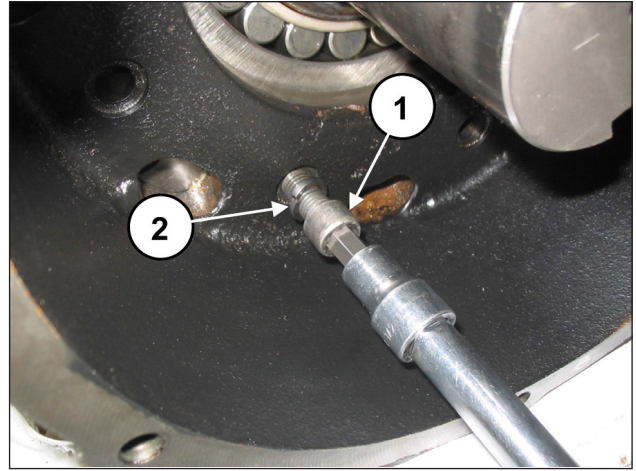

Fig. 46

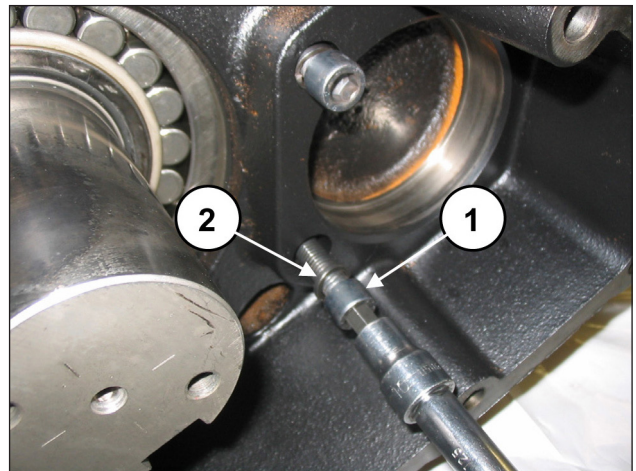

Fig. 47

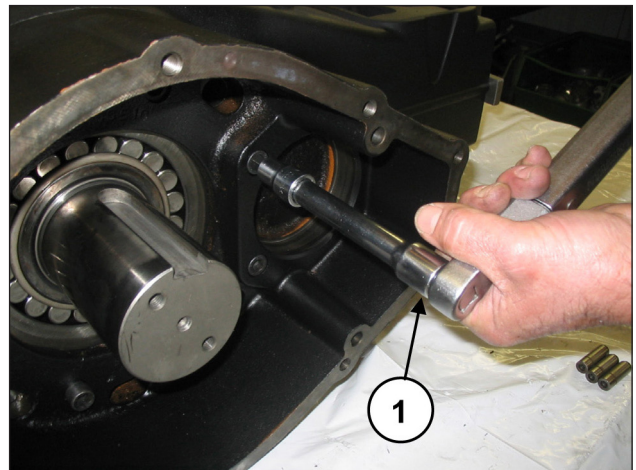

Fig. 48

Insert the pressure bush completely onto the shaft from the opposite side to the PTO (pos. ①, Fig. 49 and Fig. 50).



Fig. 49

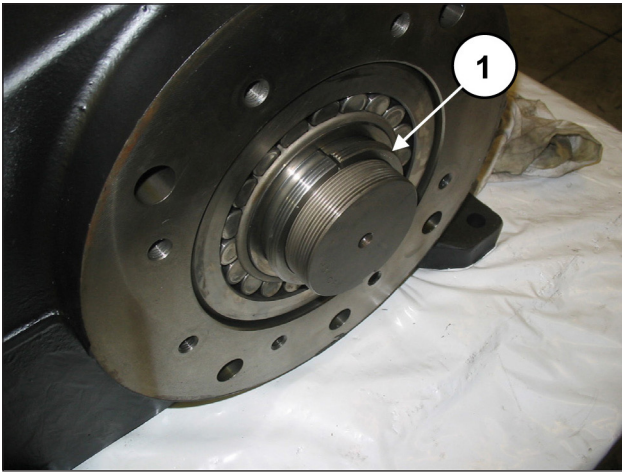

Fig. 50



The pressure bush must be inserted dry (no lubricant oils).

Insert the bush until the outside (conical) surface perfectly couples with the inside of the bearing. During insertion, make sure that the bearing stays in contact with the shaft shoulder. Measure the distance "X" indicated in Fig. 51.

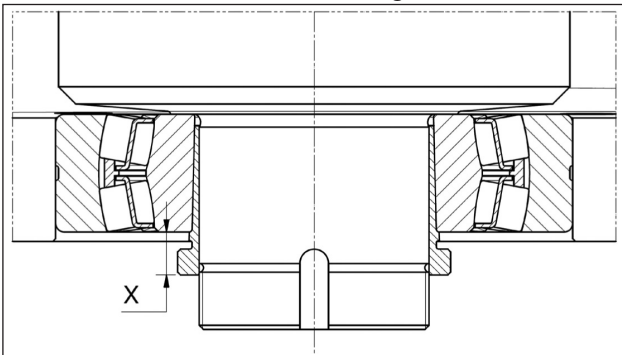

Fig. 51

Screw in the locking grub screw and tighten the bush until there is a reduction in the distance X of between 0.7 mm and 0.8 mm (Fig. 52).

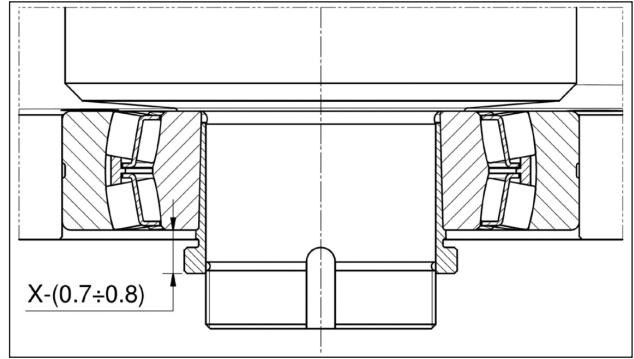

Fig. 52

Unscrew the ring nut, insert the safety washer (pos. ①, Fig. 53) and fully screw on the ring nut (pos. ①, Fig. 54), after which bend the washer's locking tab (pos. ①, Fig. 55).

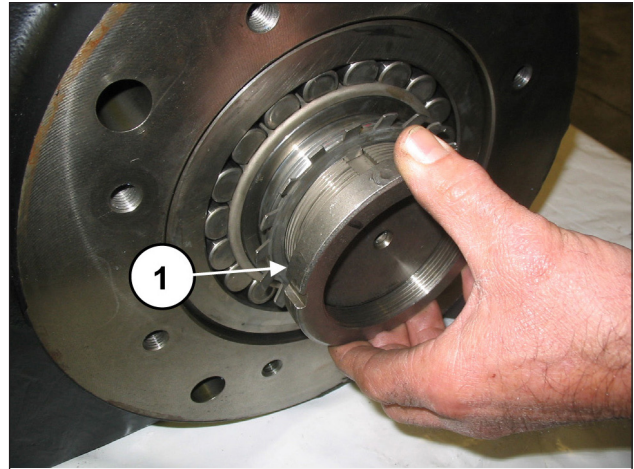

Fig. 53

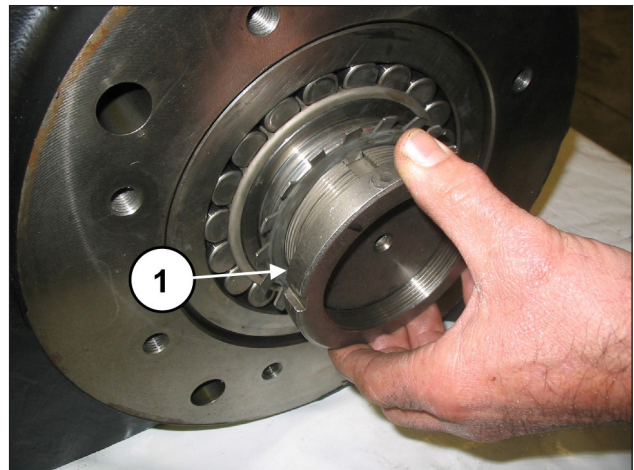

Fig. 54

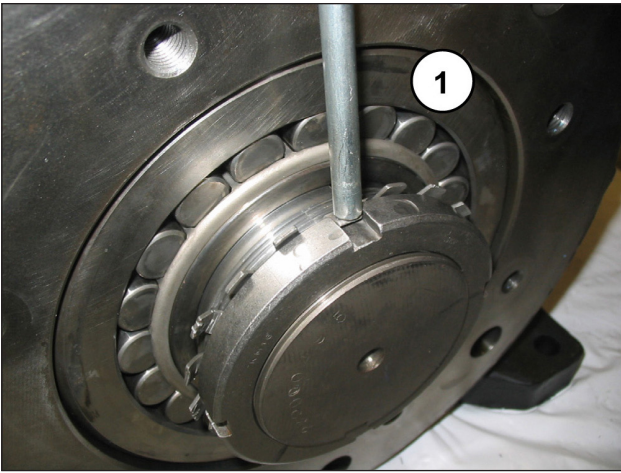

Fig. 55

Remove the tool for blocking the con-rods code 27566200 (pos. ①, Fig. 31).
Insert the upper half-bearings between the con-rods and the shaft (pos. ①, Fig. 56).



For proper assembly of the half-bearings, ensure that the reference tab on the half-bearings are positioned in their housing on the half support (pos. ①, Fig. 57).

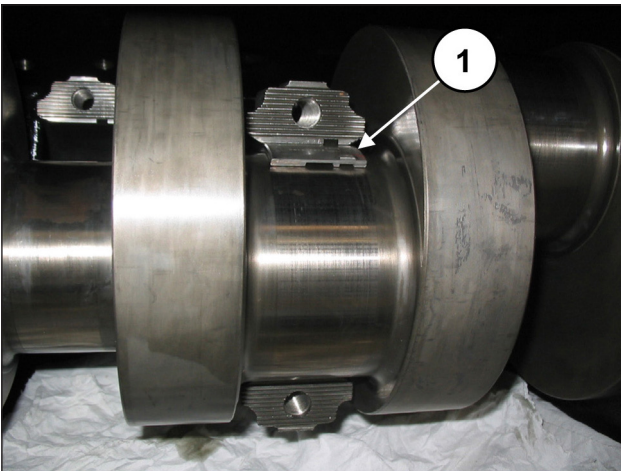

Fig. 56

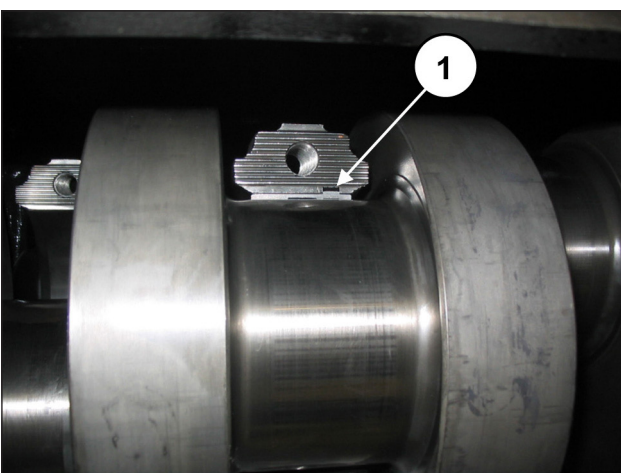

Fig. 57

Apply the lower half-bearings to the caps (pos. ①, Fig. 58) ensuring that the half-bearing reference notches are positioned in their housing on the cap (pos. ②, Fig. 58). Fasten the caps to the half supports by means of M12x1.25x87 screws (pos. ①, Fig. 59).



Note the correct assembly direction of the caps. Numbering must be turned upward.

Calibrate the screws with a torque wrench as indicated in chapter 3, bringing the screws to tightening torque at the same time.

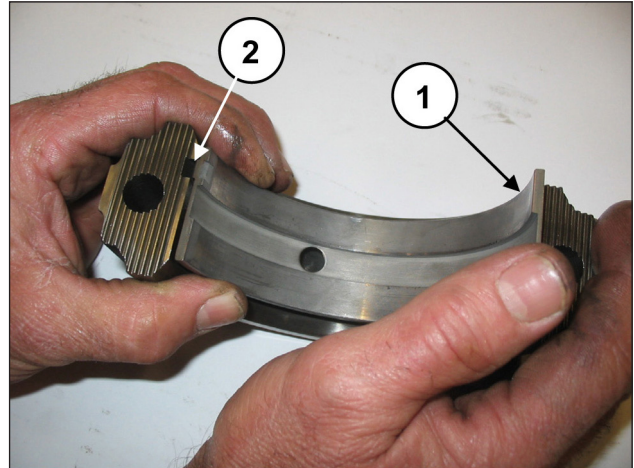

Fig. 58

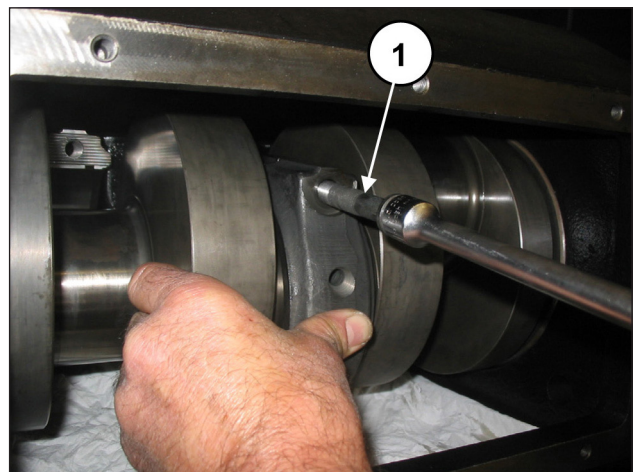

Fig. 59



After finishing this operation, verify that the con-rods have axial clearance in both directions.

Pre-assemble the bearing on the pinion (pos. ①, Fig. 60) and fully insert the pinion in the seat on the reduction gear box (pos. ①, Fig. 61) using an extractor hammer.

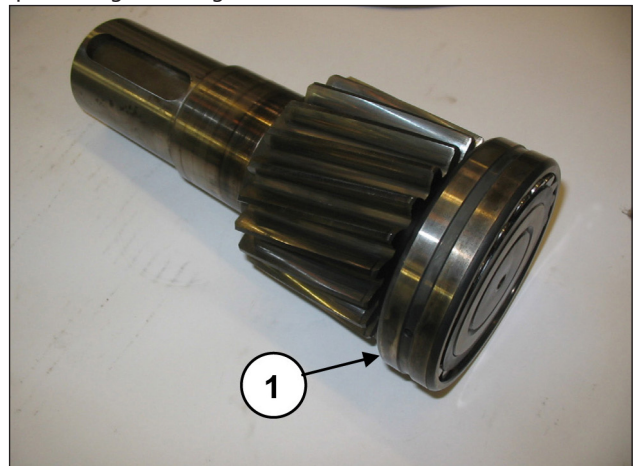

Fig. 60

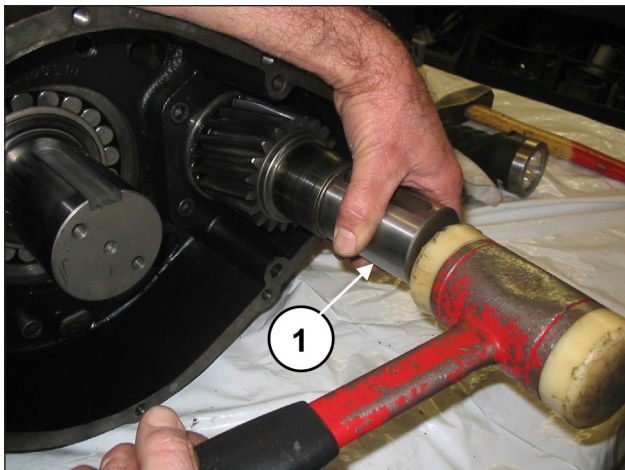

Fig. 61

Apply tab 22x14x100 in the shaft housing (pos. ①, Fig. 62) and insert the ring gear on the shaft.
Fasten the ring gear stop (pos. ①, Fig. 63) using the 2 M10x25 screws (pos. ②, Fig. 63).
Calibrate the screws with a torque wrench as indicated in chapter 3.

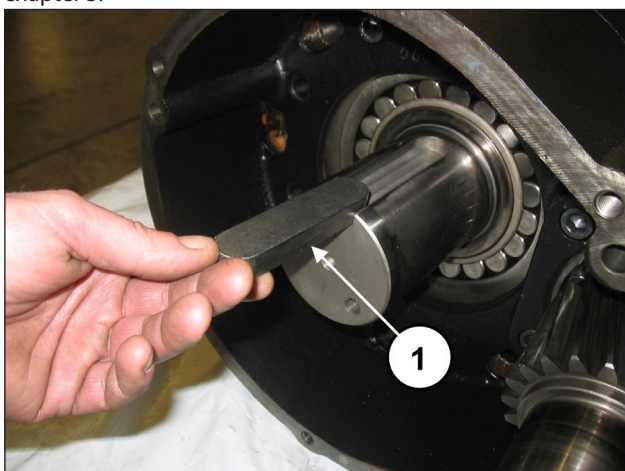

Fig. 62

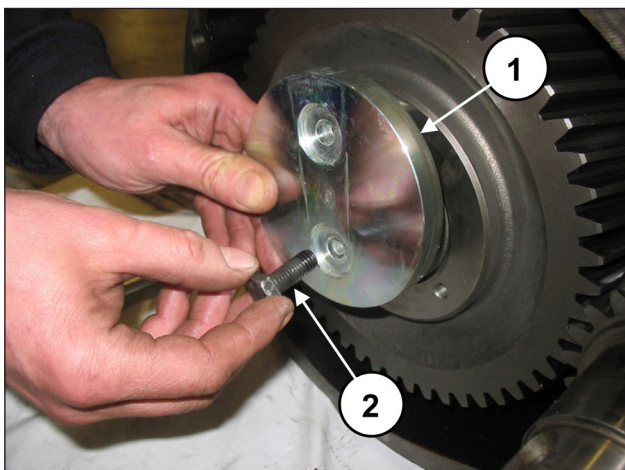

Fig. 63

Apply the 3 Ø12x40 pins on the reduction gear box (pos. ①, Fig. 64) and insert the gasket (pos. ①, Fig. 65).

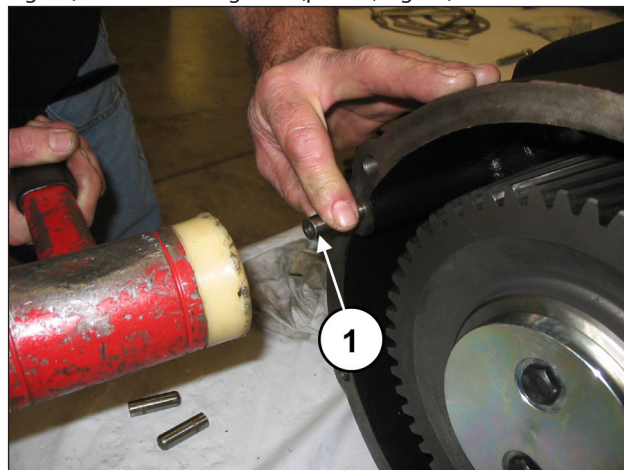

Fig. 64

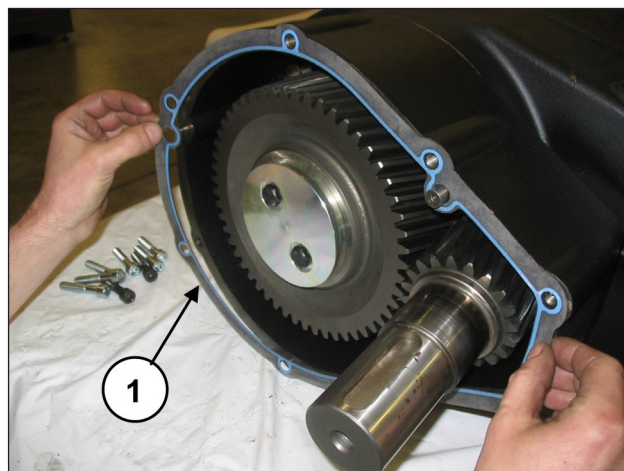

Fig. 65

Mount the bearing on the reduction gear cover (pos. ①, Fig. 66).

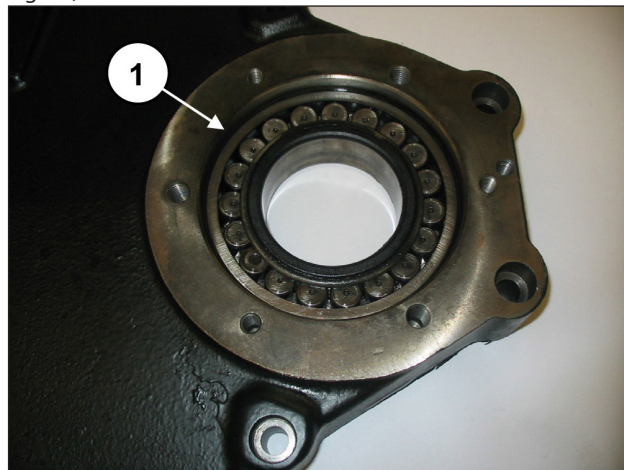

Fig. 66

Mount the reduction gear cover (pos. ①, Fig. 67) and fasten it with 8 M10x50 screws (pos. ①, Fig. 68). Use a buffer to prevent the bearing from being able to come out of its seat (pos. ①, Fig. 69).

Calibrate the screws with a torque wrench as indicated in chapter 3.

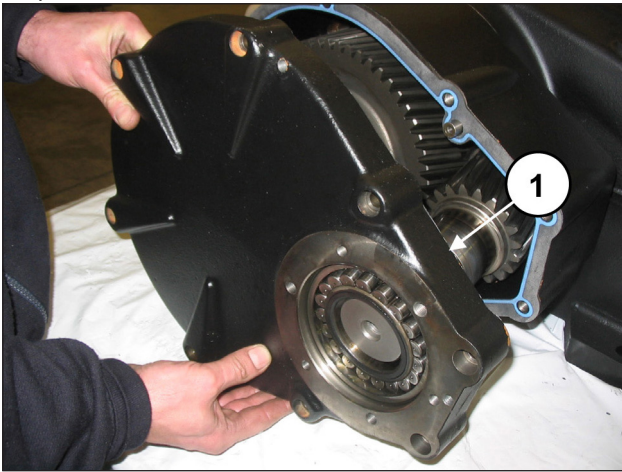

Fig. 67

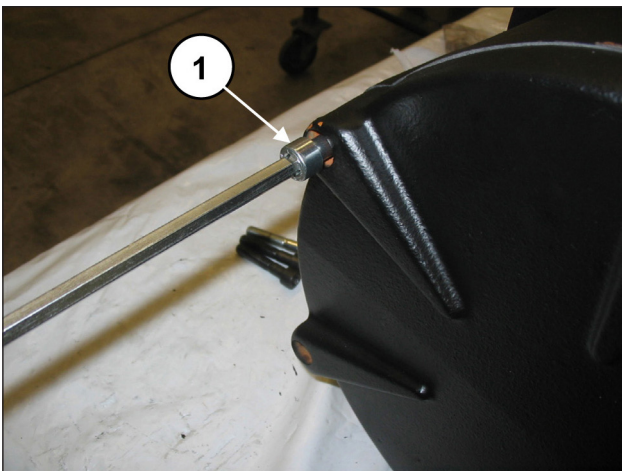

Fig. 68



Fig. 69

Insert the oil seal inside the reduction gear flange using the tools code 27515900 and 27548200 (pos. ①, Fig. 70). Before proceeding with seal ring assembly, check lip seal conditions. If replacement is necessary, position the new ring on the bottom of the groove as indicated in Fig. 71.



If the shaft should present a diameter wear corresponding to the lip seal, to prevent grinding, position the ring in the second stroke as indicated in Fig. 71.

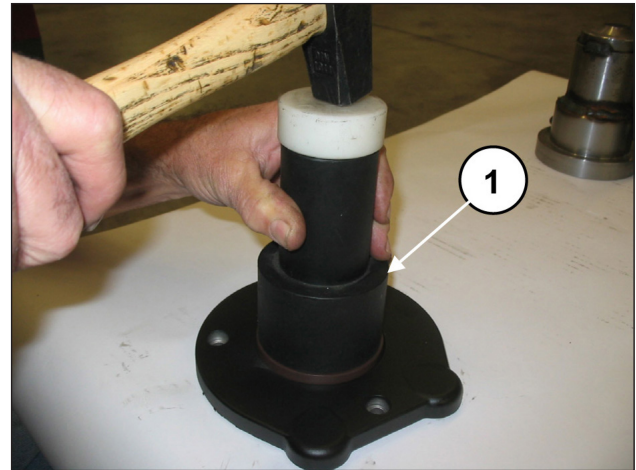

Fig. 70

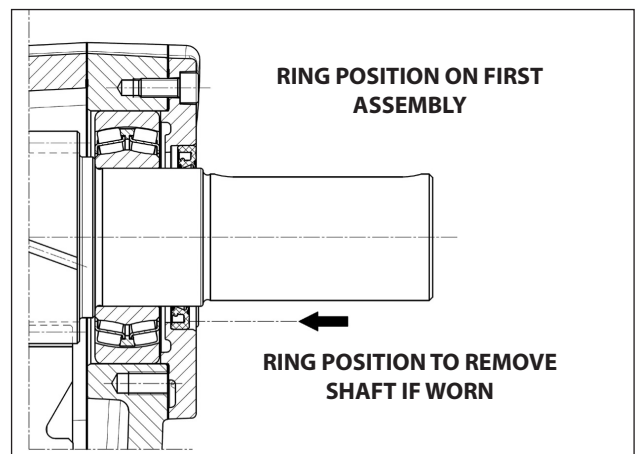

Fig. 71

Fit the reduction gear flange with its gasket onto the reduction gear box (pos. ①, Fig. 72) and screw it on with 3 M8x18 screws (pos. ①, Fig. 73).



To prevent damage to the seal ring, take special care when inserting the flange on the pinion

Calibrate the screws with a torque wrench as indicated in chapter 3.

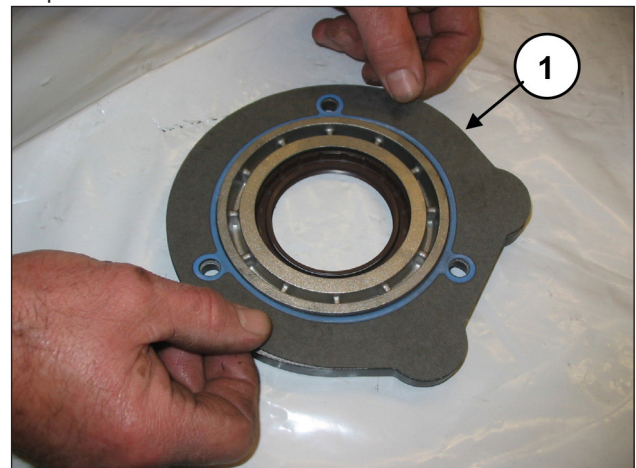

Fig. 72

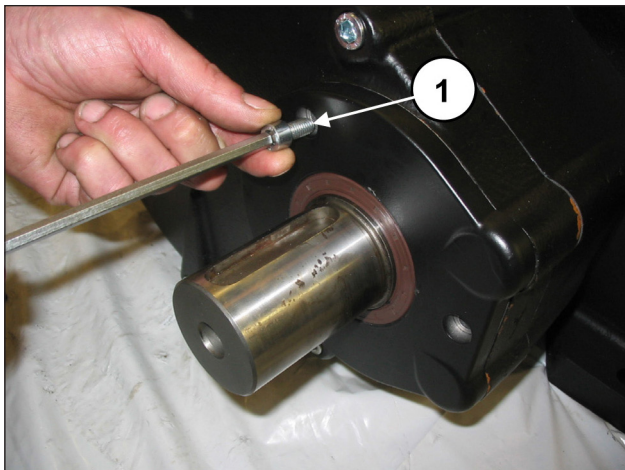

Fig. 73

Insert the tab 16x10x90 on the pinion.
 Insert the O-ring on the rear cover (pos. ①, Fig. 74) and fasten it to the casing with 10 x M8x18 screws (pos. ①, Fig. 75).
 Calibrate the screws with a torque wrench as indicated in chapter 3.

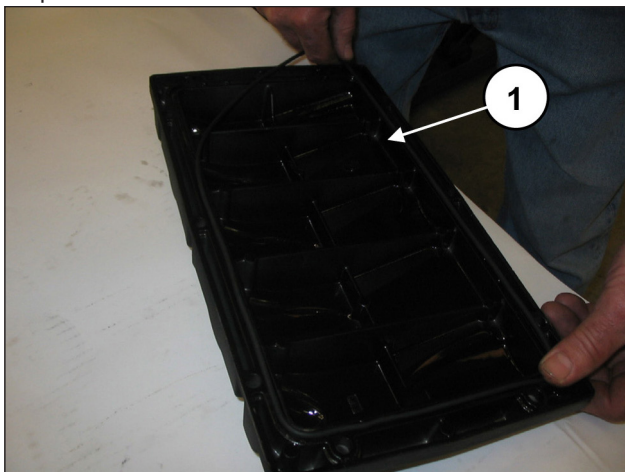

Fig. 74

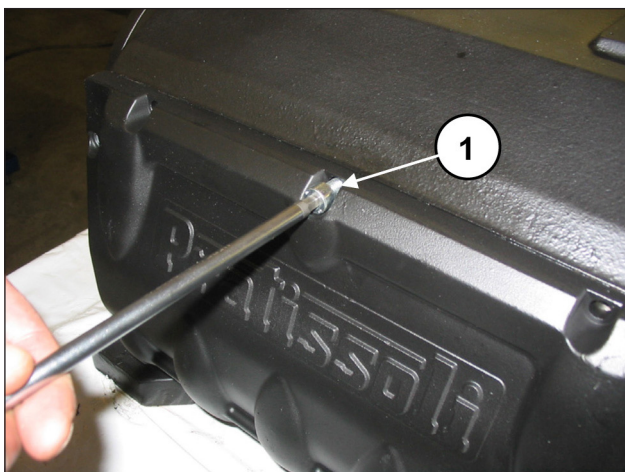

Fig. 75

Assemble the bearing cover (and relative seal) (pos. ①, Fig. 76) using 8 x M12x30 screws (pos. ①, Fig. 77).
 Calibrate the screws with a torque wrench as indicated in chapter 3.



Fig. 76



Fig. 77

Complete the assembly of the mechanical part by fitting the plugs and lifting eyebolts with the relevant O-rings.
 Insert oil in the casing as indicated in the **Use and maintenance manual**, par. 7.4.

2.1.3 Classes of increase

INCREASE TABLE FOR BEND SHAFTS AND CON-ROD HALF-BEARINGS			
Recovery classes (mm)	Upper Half-Bearing Code	Lower Half-Bearing Code	Correction on the shaft pin diameter (mm)
0.25	90931100	90930100	Ø92.75 0/-0.03 Ra 0.4 Rt 3.5
0.50	90931200	90930200	Ø92.50 0/-0.03 Ra 0.4 Rt 3.5

INCREASE TABLE FOR PUMP CASING AND PISTON GUIDE		
Recovery classes (mm)	Piston Guide Code	Adjustments on the Pump Casing housing (mm)
1.00	79050543	Ø81 H6 +0.022/0 Ra 0.8 Rt 6

2.2 REPAIRING HYDRAULIC PARTS

2.2.1 Dismantling the head – valve units

The head needs preventive maintenance as indicated in the *Use and maintenance manual*.

Operations are limited to inspection or replacement of valves, if necessary.

Proceed as follows to remove the valve units:

Unscrew the 8 M16x55 screws of the valve cover (pos. ①, Fig. 78) and remove the cover (pos. ①, Fig. 79).



Fig. 78

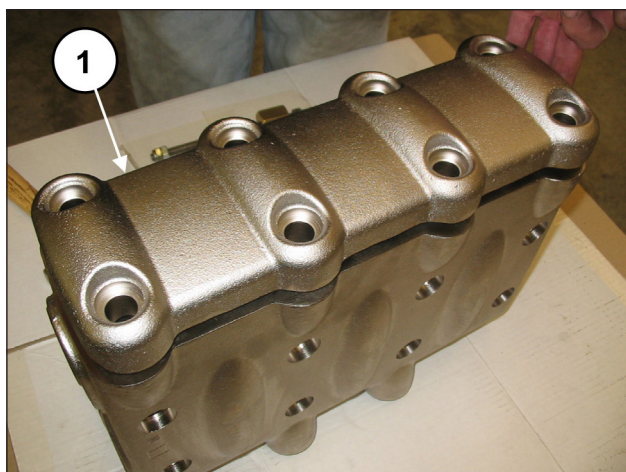

Fig. 79

Extract the valve plug with the use of an extractor hammer to be applied on the M10 hole of the valve plug (pos. ①, Fig. 80).

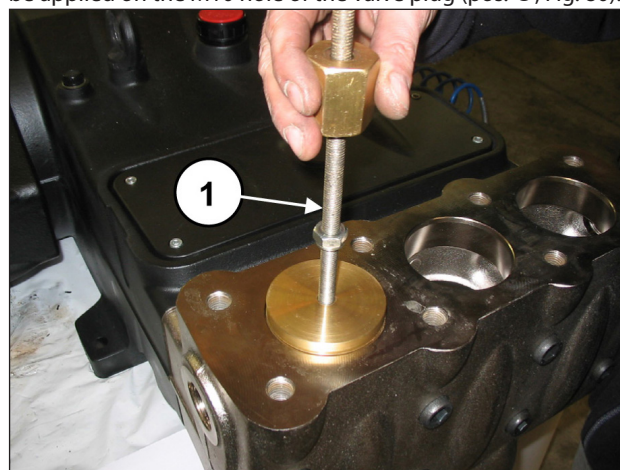

Fig. 80

Remove the spring (pos. ①, Fig. 81).

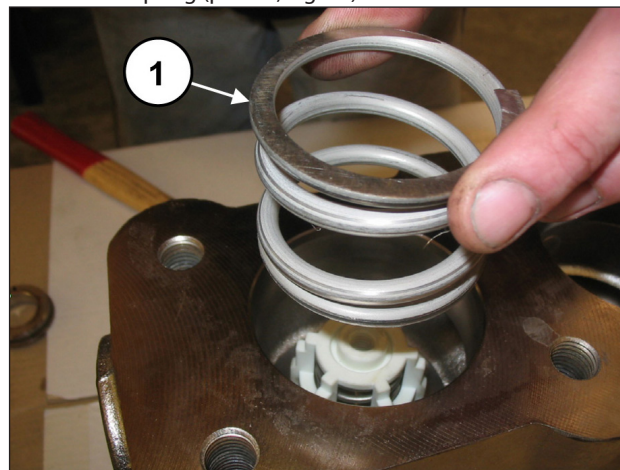

Fig. 81

Extract the outlet valve unit with an extractor hammer to be applied on the M10 hole of the valve guide (pos. ①, Fig. 82).

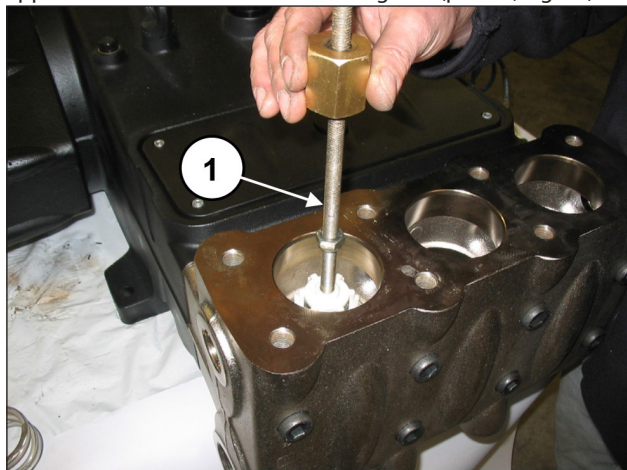

Fig. 82



If removing the outlet valve unit proves to be particularly difficult (for example because of incrustations due to prolonged inactivity of the pump), use the extractor tool (code 27516400).

Take out the valve guide spacer using an 8 mm hex wrench (pos. ①, Fig. 83).

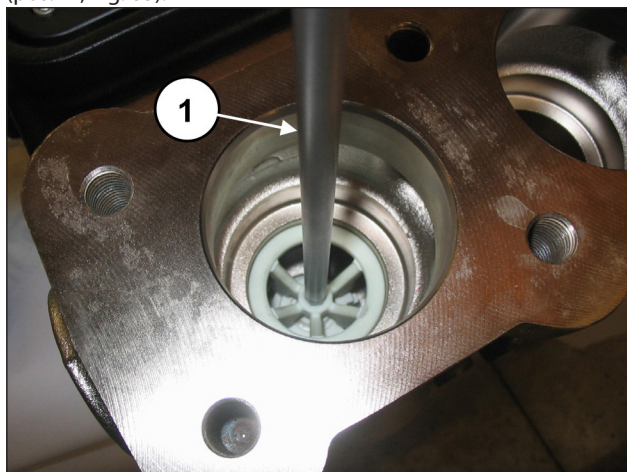

Fig. 83

Extract the suction valve unit with an extractor hammer to be applied on the M10 hole of the valve guide (pos. ①, Fig. 84).

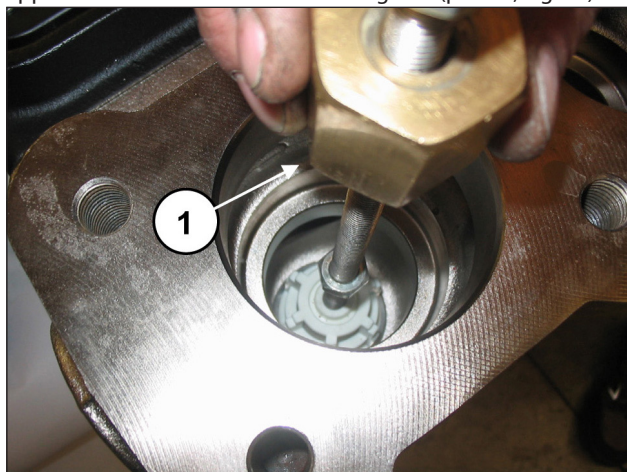

Fig. 84



If removing the suction valve unit proves to be particularly difficult (for example because of incrustations due to prolonged inactivity of the pump), use the extractor tool (code 27516200 (versions with Piston Ø: 40 - 45 - 50) or code 27516300 (versions with Piston Ø: 55 - 60 - 65).

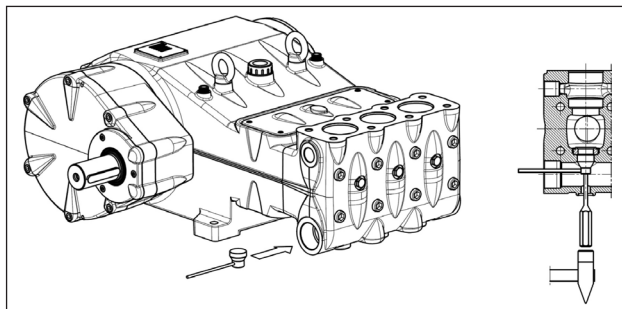

Fig. 85

Unscrew the valve opening device by means of a 30 mm spanner (pos. ①, Fig. 86).

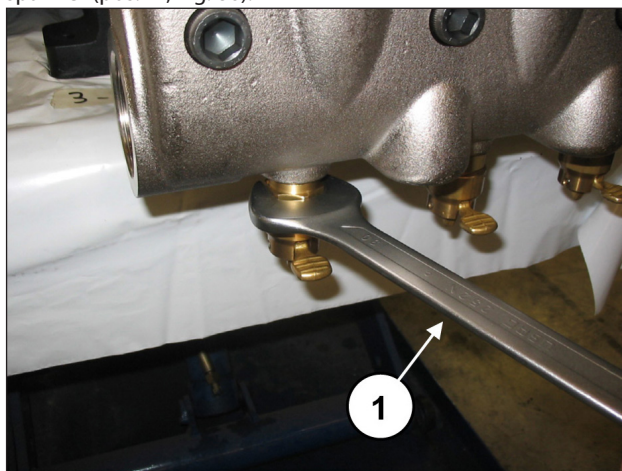

Fig. 86

Remove the suction and outlet valve units, unscrewing an M10 screw in such a way to press on the inner guide and remove the valve guide from the valve housing (pos. ①, Fig. 87).

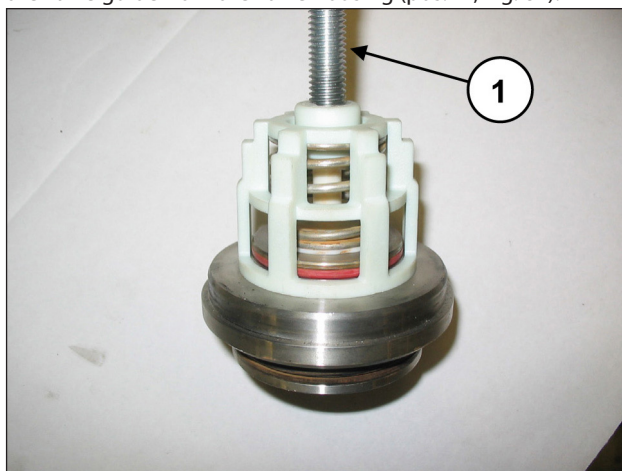

Fig. 87

2.2.2 Assembling the head – valve units



Pay particular attention to the conditions of the various components and replace if necessary. At every valve inspection, replace all O-rings both in the valve unit and in the valve plugs.



Before repositioning the valve units, thoroughly clean and dry the relative housings on the head indicated by the arrows (pos. ①, Fig. 88).

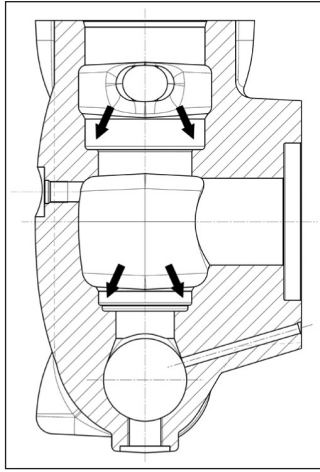

Fig. 88

Proceed with reassembly following the reverse order indicated in par. 2.2.1.

Assemble the suction and outlet valve units (Fig. 89 and Fig. 90) taking care not to invert the previously disassembled springs.

To facilitate insertion of the valve guide in its housing, you can use a pipe resting on the horizontal guide planes (Fig. 91) and use an extractor hammer acting on the whole circumference



Fig. 89

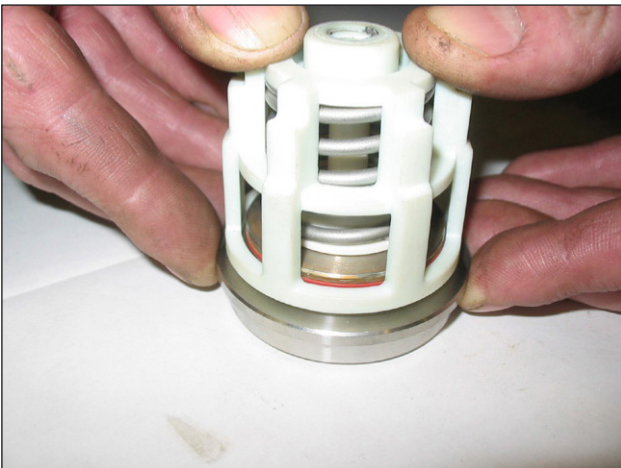

Fig. 90

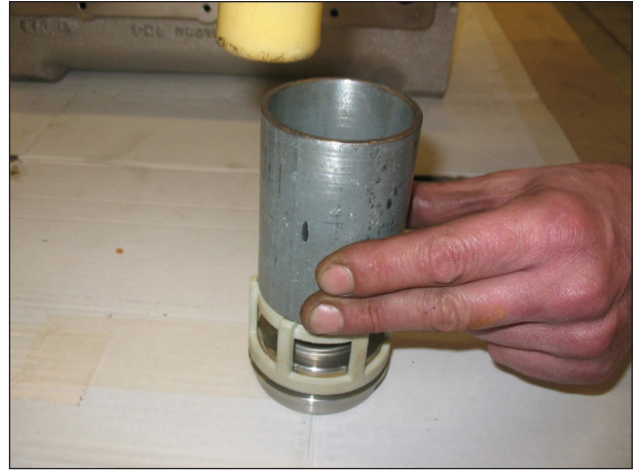

Fig. 91



Proceed with insertion of the valve units (suction and outlet) in the head, taking care to follow the correct insertion sequence of O-rings and anti-extrusion rings.

The proper sequence of valve unit assembly on the head is as follows:

Insert the anti-extrusion ring, exploded view pos. 4 (pos. ①, Fig. 92).

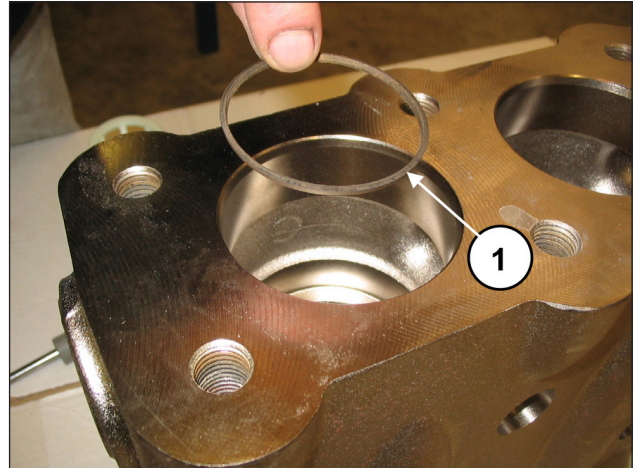

Fig. 92

Insert the O-ring, exploded view pos. 5 (pos. ①, Fig. 93).

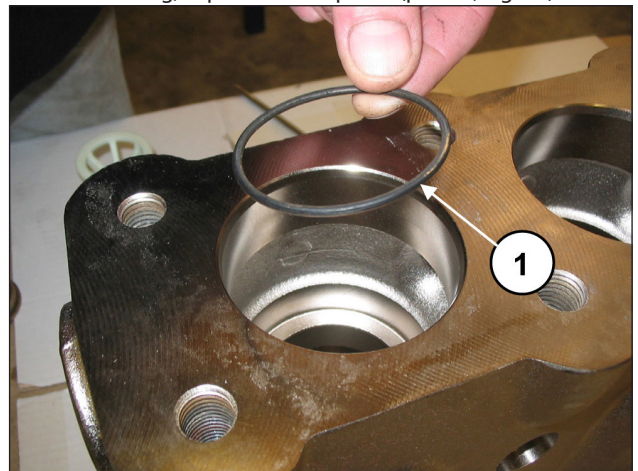

Fig. 93

Ensure that the O-ring and anti-extrusion ring are perfectly placed in their housings.

Insert the suction valve unit (pos. ①, Fig. 94) and then the spacer (pos. ①, Fig. 95).
The complete valve unit must be fully inserted into the bottom and should look like the image in pos. ①, Fig. 95.

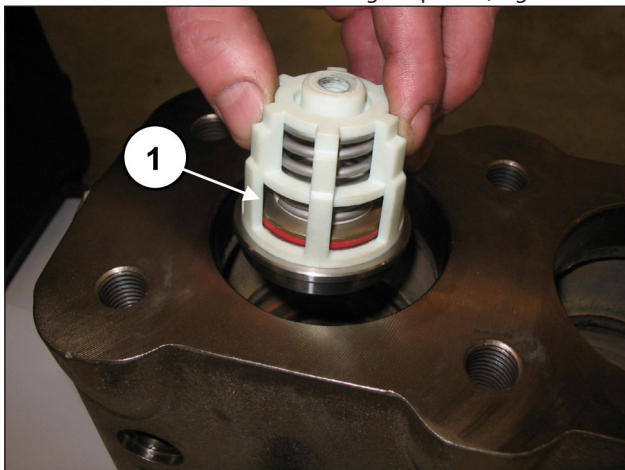

Fig. 94

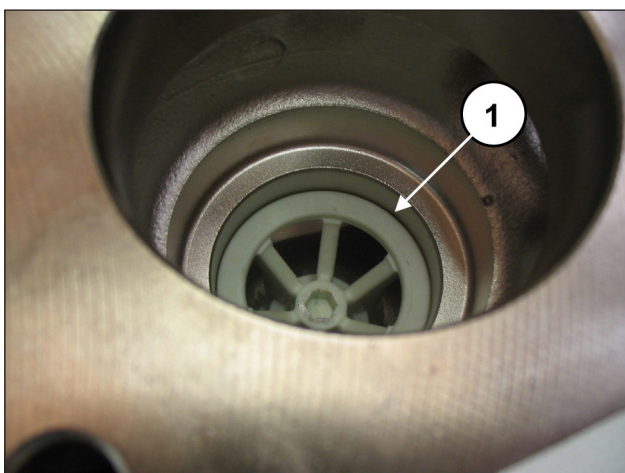

Fig. 95

Assemble the O-ring, exploded view pos. 5 (pos. ①, Fig. 96) and the anti-extrusion ring, exploded view pos. 15 (pos. ②, Fig. 96) on the outlet valve housing.

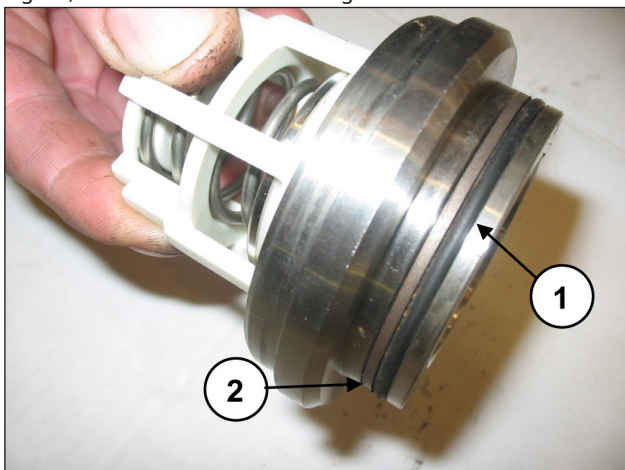

Fig. 96

Insert the outlet valve unit (pos. ①, Fig. 97). The valve unit must be fully inserted into the bottom and should look like the image in pos. ①, Fig. 98.

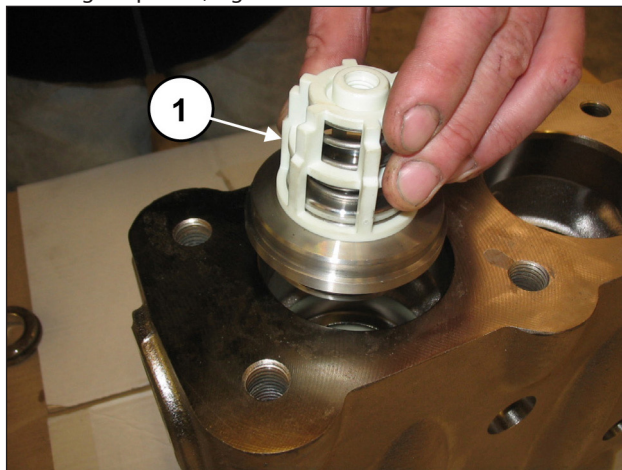

Fig. 97

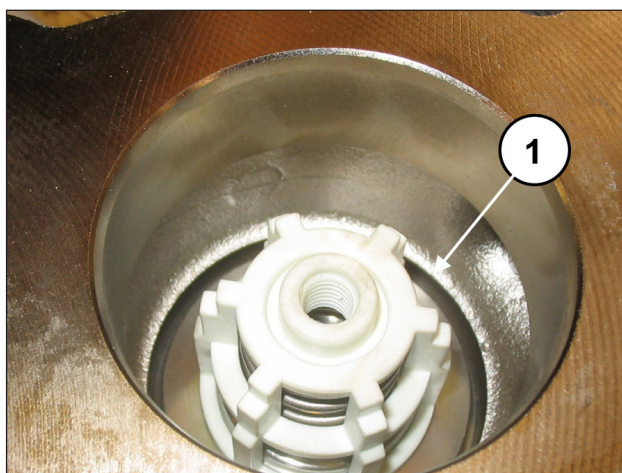

Fig. 98

Insert the anti-extrusion ring, exploded view pos. 16 (pos. ①, Fig. 99).

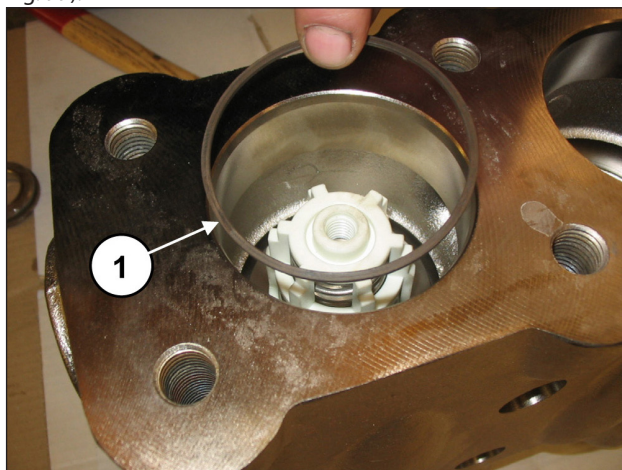

Fig. 99

Insert the O-ring, exploded view pos. 17 (pos. ①, Fig. 100).

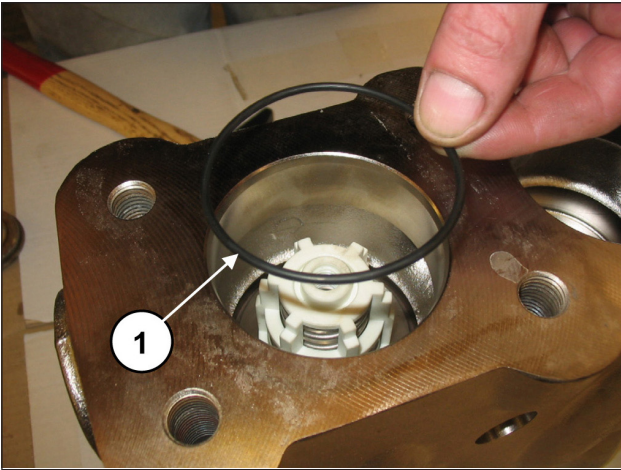

Fig. 100



Pay special attention to O-ring insertion indicated in pos. ①, Fig. 101.

Use a special tool code 27516000 (versions with Piston Ø: 40 - 45 - 50) or code 27516100 (versions with Piston Ø: 55 - 60 - 65) to prevent the O-ring getting cut during insertion.

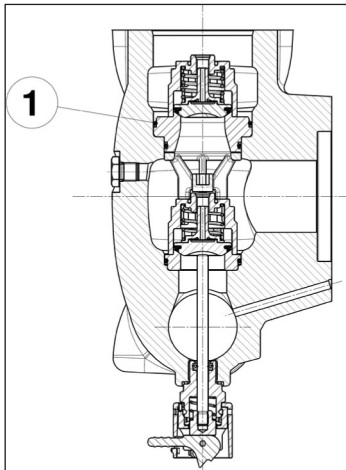

Fig. 101

Insert the valve housing ring (pos. ①, Fig. 102) and the spring (pos. ①, Fig. 103).

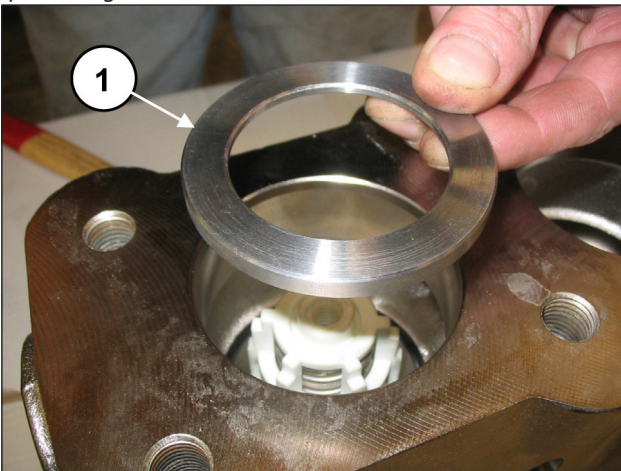

Fig. 102

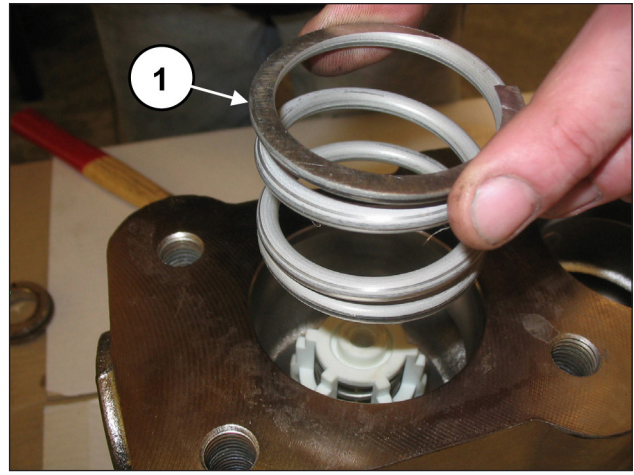

Fig. 103

Assemble the O-ring, exploded view pos. 17 (pos. ①, Fig. 104) and the anti-extrusion ring, exploded view pos. 21 (pos. ②, Fig. 104) on the outlet valve plug.

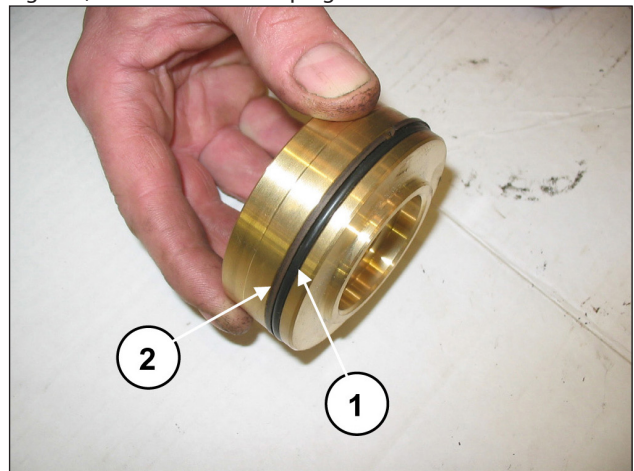

Fig. 104

Insert the valve plug housing complete with O-ring and anti-extrusion rings.

After having completed assembly of the valve units and the valve plug, apply the valve cover (pos. ①, Fig. 105) and screw in the 8 M16x55 screws (pos. ①, Fig. 106).

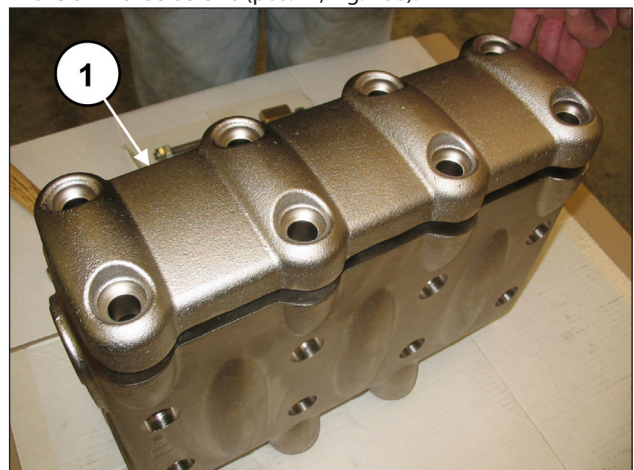

Fig. 105

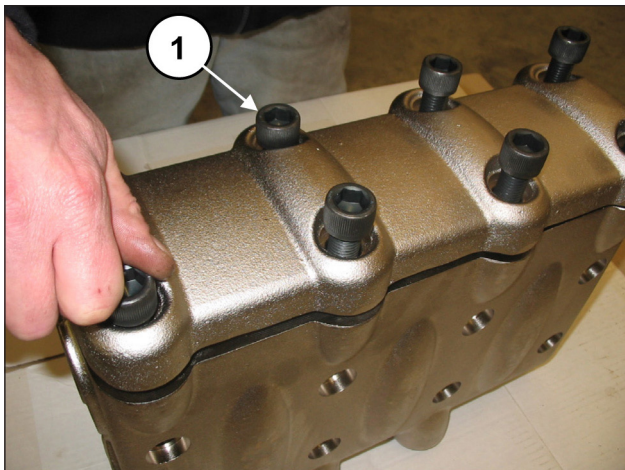

Fig. 106

Assemble the pump casing head (pos. ①, Fig. 107) taking care not to hit the pistons and screw in the 8 M16x180 screws (pos. ①, Fig. 108).

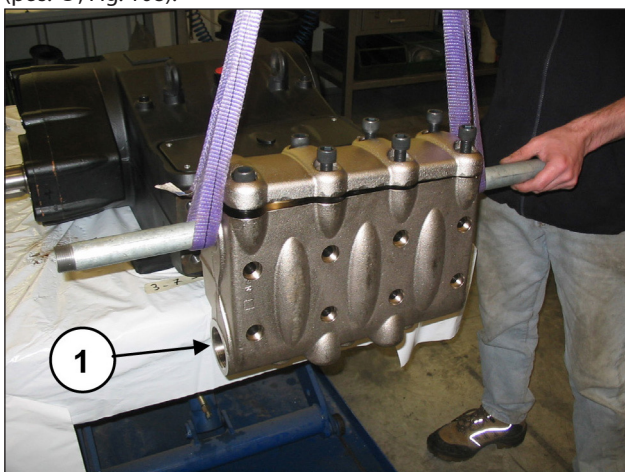

Fig. 107

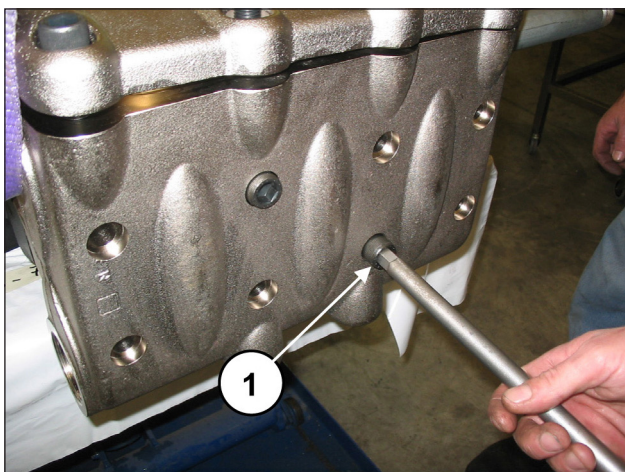

Fig. 108

Proceed with calibration of the M16x180 screws with a torque wrench as indicated in chapter 3.



Tighten the 8 M16x180 screws starting crosswise from the 4 inner screws (see Fig. 107), to then continue with the 4 outer screws, always tightening crosswise

Calibrate the M16x55 cover screws with a torque wrench as indicated in chapter 3.

Apply the valve opening devices (pos. ①, Fig. 109) and screw them in with the use of a 30 mm spanner (pos. ①, Fig. 110).

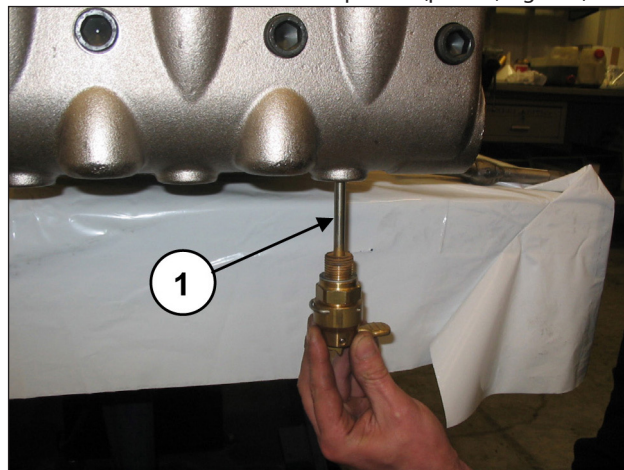

Fig. 109

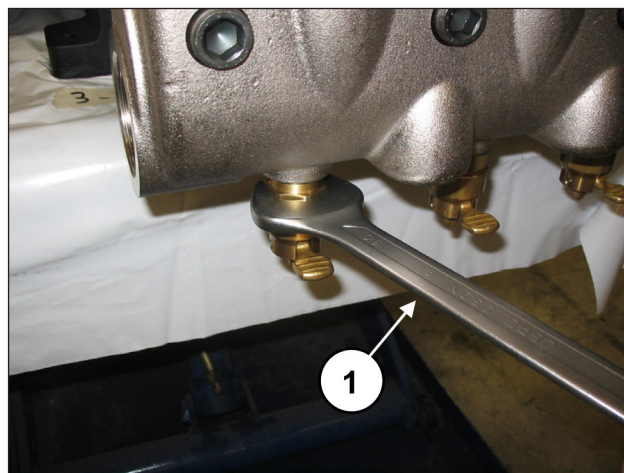

Fig. 110

2.2.3 Disassembly of the piston unit – supports – seals

The piston unit requires preventive checks as indicated in the preventive maintenance table in the **Use and maintenance manual**.

Maintenance is limited to visual inspection of any drainage from the hole present on the lower cover. If abnormalities / variations on the outlet pressure gauge or dripping from the drainage hole circuit are detected, the seal pack will have to be checked and replaced.

Proceed as follows to remove the piston units:

To access the piston unit, unscrew the M16x180 screws and remove the head.



Remove the head taking care to avoid hitting the pistons

Disassemble pistons unscrewing the fixing screws (pos. ①, Fig. 111).

Remove the piston from the seal support and check that its surfaces do not present any scratches, signs of wear or cavitation

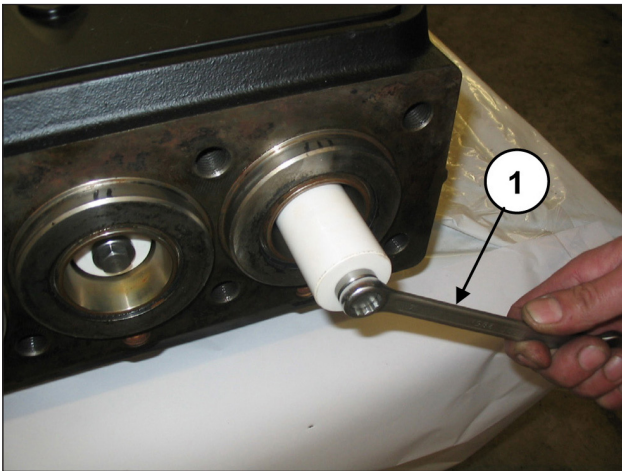

Fig. 111

Remove the upper inspection cover, unscrewing the 4 fixing screws (pos. ①, Fig. 112).

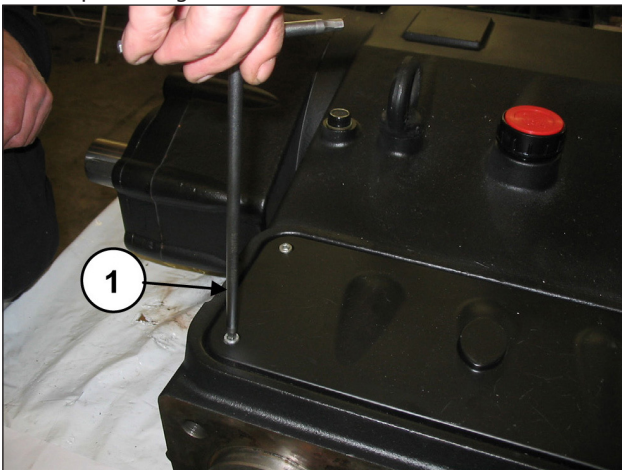

Fig. 112

Manually turn the shaft in such a way to bring the 3 pistons to the top dead centre position.

Insert the buffering tool code 27516600 between the piston guide and the piston (pos. ①, Fig. 113).

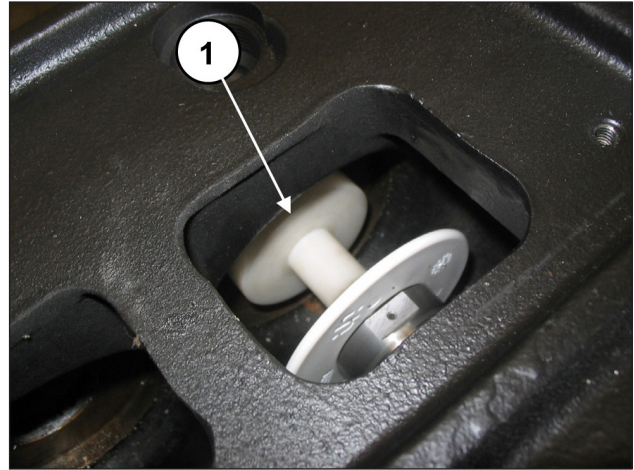

Fig. 113

Turning the shaft, have the piston guide move forward so that the buffer, moving ahead, can expel the seal support and the entire piston unit (pos. ①, Fig. 114).

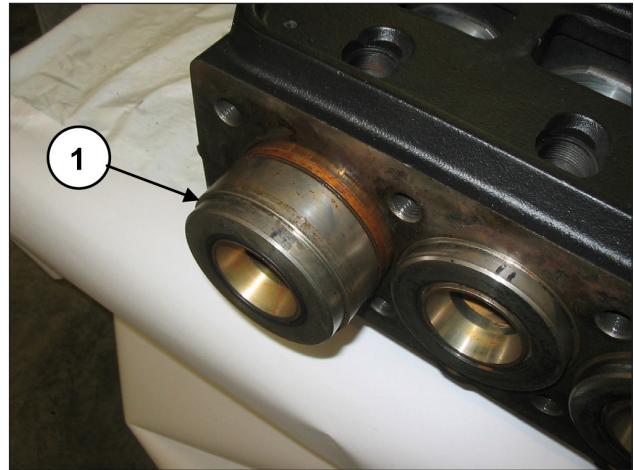

Fig. 114

Extract the seal support unit and the buffering tool. Remove the seal support bottom O-ring should it remain inside the pump casing (pos. ①, Fig. 115).

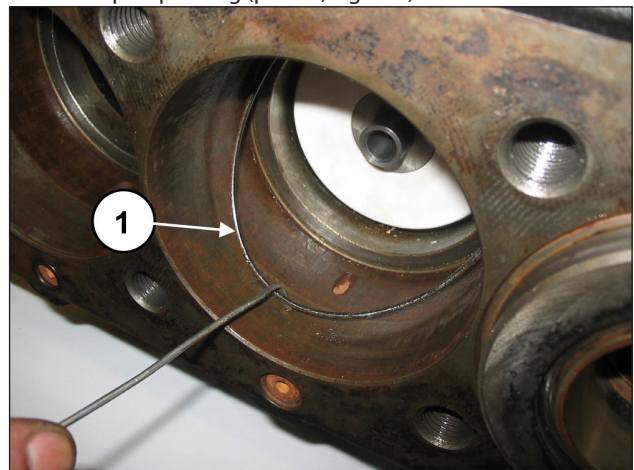

Fig. 115

Slip the spray-guard rings off the piston heads (pos. ①, Fig. 116).

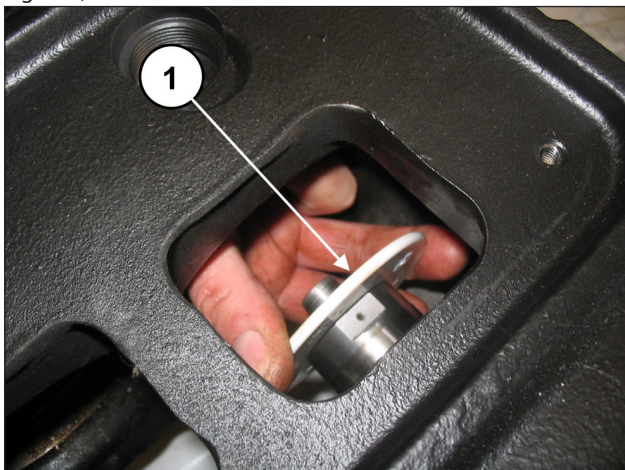

Fig. 116

If you need to replace the piston guide seal ring, you need to remove the oil seal cover as follows:
Unscrew the two screws locking the oil seal cover (pos. ①, Fig. 117).

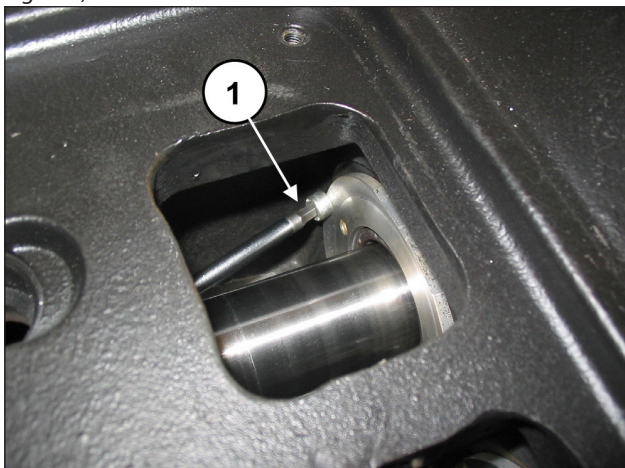

Fig. 117

Position the piston guide at bottom dead centre, screw the extractor code 27516400 including the M5 adapter code 27516500 in the holes in the cover (pos. ①, Fig. 118) and remove the oil seal cover from the pump assembly (pos. ①, Fig. 119).

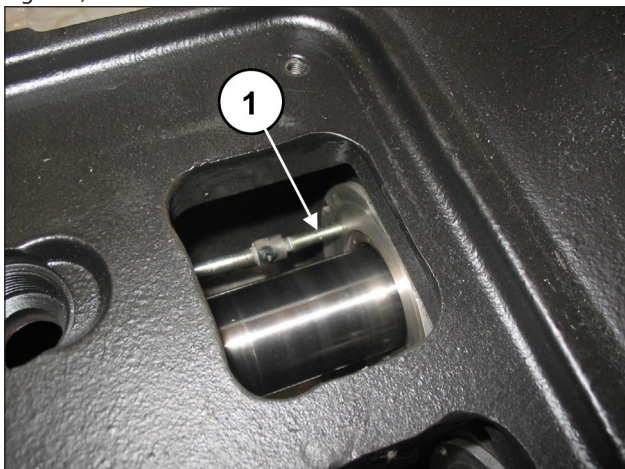

Fig. 118



Fig. 119

Replace the oil seal (pos. ①, Fig. 120) and the outside O-ring (pos. ②, Fig. 120).

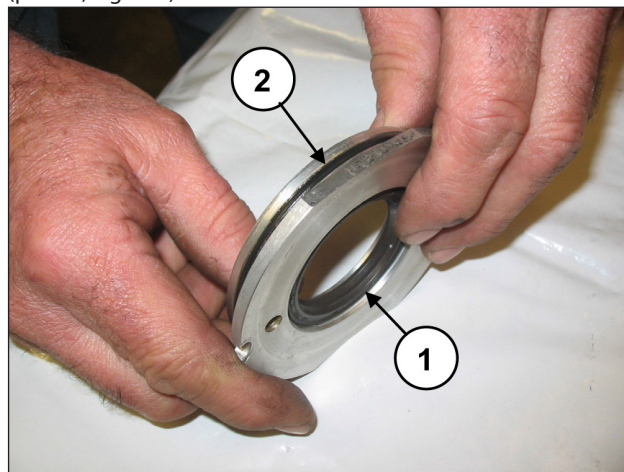

Fig. 120

Separate the seal support from the liner (pos. ①, Fig. 121) to access the pressure seals (pos. ①, Fig. 122).

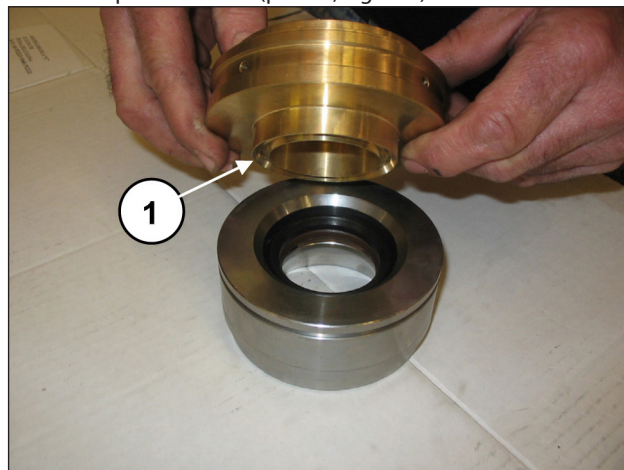

Fig. 121

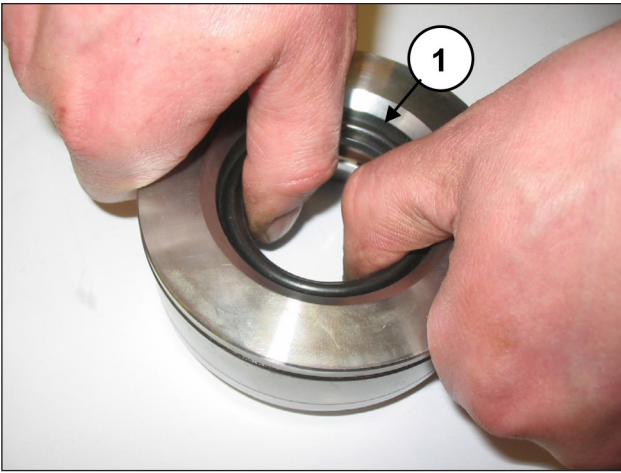

Fig. 122

To remove the low pressure seal, use a thickness gauge or another tool which will not damage the seal support housing (pos. ①, Fig. 123).

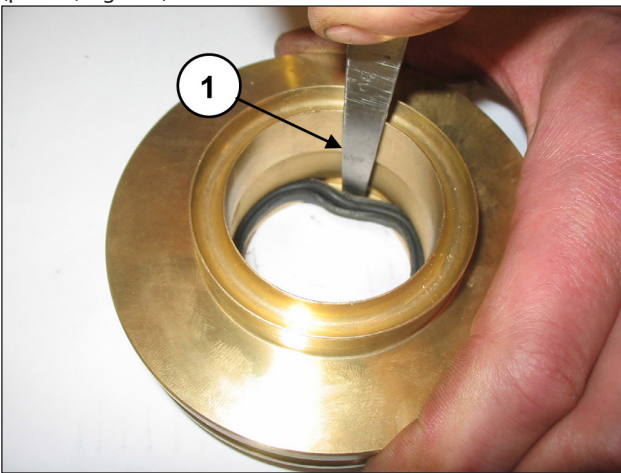

Fig. 123

2.2.4 Assembling the piston unit – supports – seals

Proceed with reassembly following the reverse order indicated in par. 2.2.3.



Replace the pressure seals moistening the lips with silicone grease (without spreading it), taking extra care not to damage them during liner insertion.



The O-rings and the pressure seals must be replaced at each disassembly.

Insert the low pressure seal in the seal support (pos. ①, Fig. 124) paying attention to the mounting direction which requires that the sealing lip be set forward (towards the head).

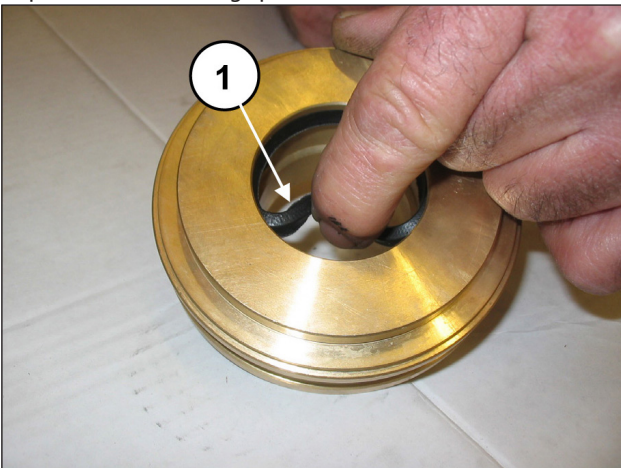

Fig. 124

Install the head ring (pos. ①, Fig. 125), the high pressure seal (pos. ①, Fig. 126) and the restop ring (pos. ①, Fig. 127).



Fig. 125

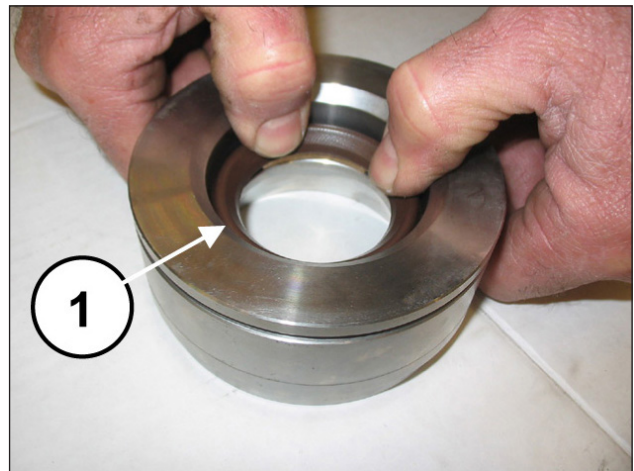

Fig. 126



Fig. 127

Join the seals support to the liner (pos. ①, Fig. 128).

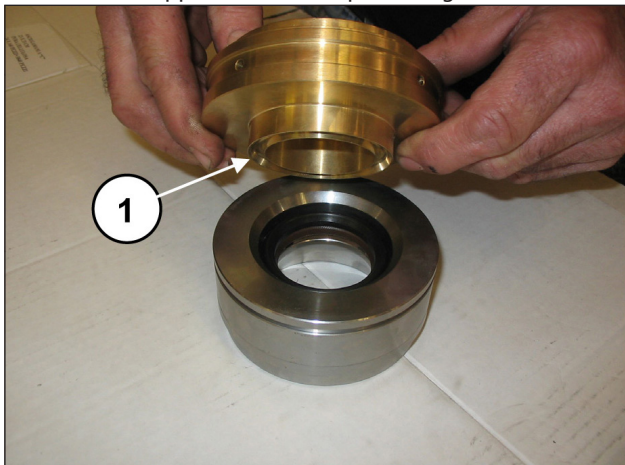

Fig. 128

Mount the oil seal in the oil seal cover (pos. ①, Fig. 129) using a buffer code 27910900.

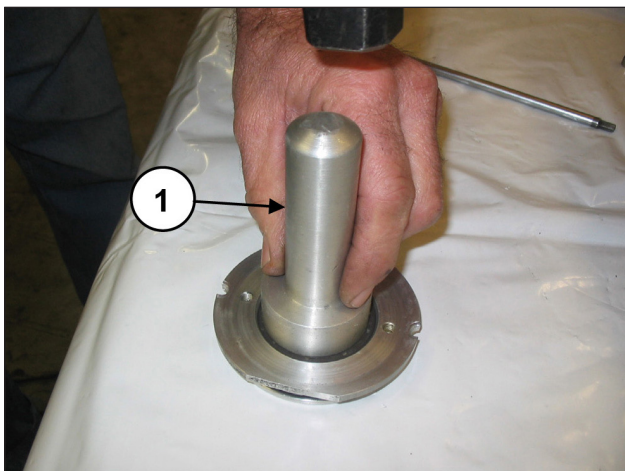

Fig. 129

Position the O-ring (pos. ①, Fig. 130) in the seat of the oil seal cover and insert the assembly mounted in the casing into the seat (pos. ①, Fig. 131).

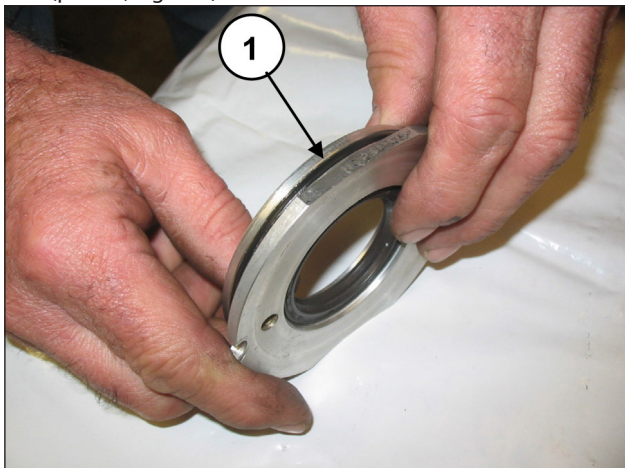

Fig. 130

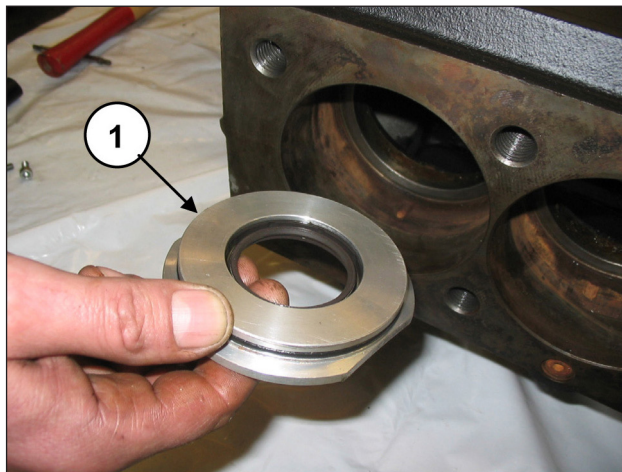

Fig. 131

Make sure that the cover completely enters its seat (pos. ①, Fig. 132) being careful not to damage the lip of the seal ring. Screw in the oil seal covers using 2 x M6x14 screws (pos. ①, Fig. 133).

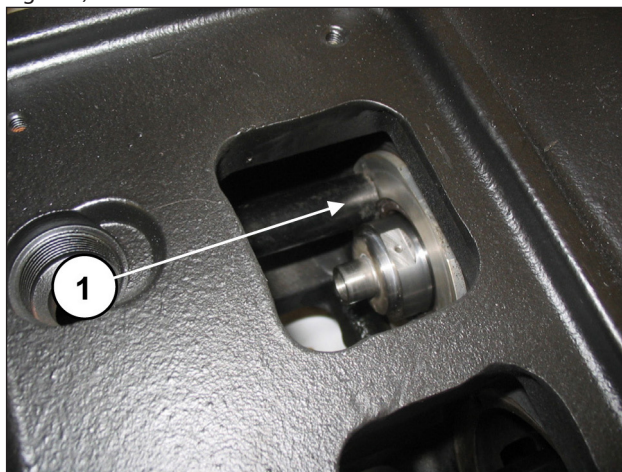

Fig. 132

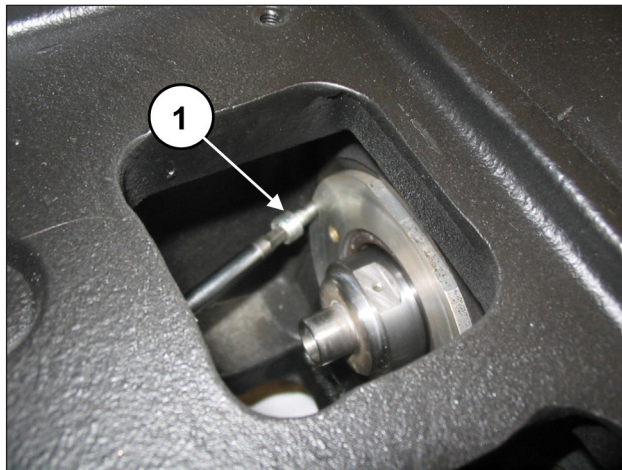

Fig. 133

Calibrate the screws with a torque wrench as indicated in chapter 3.

Position the spray-guard together with the O-ring in the housing on the piston guide (pos. ①, Fig. 134 and Fig. 135).

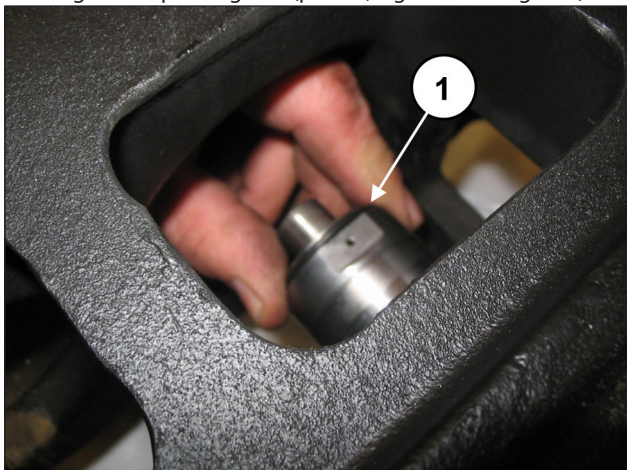

Fig. 134

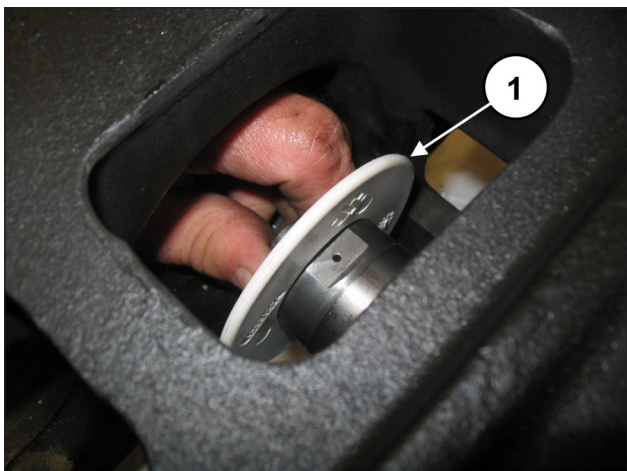

Fig. 135

Insert the Ø10x18x0.9 washer in the piston fixing screw (pos. ①, Fig. 136).

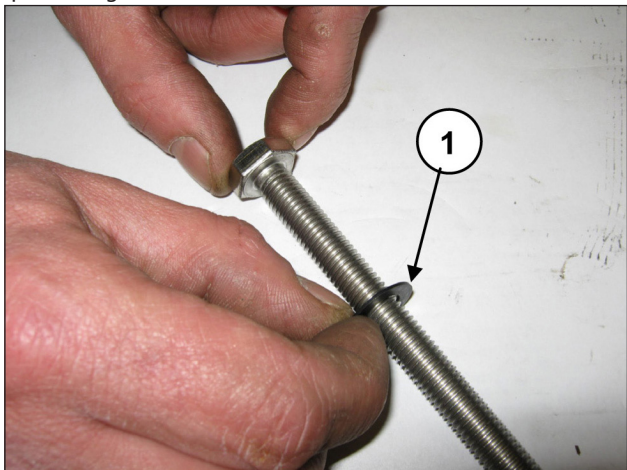

Fig. 136

Install the pistons on their respective guides (pos. ①, Fig. 137) and fasten them as per pos. ①, Fig. 138.

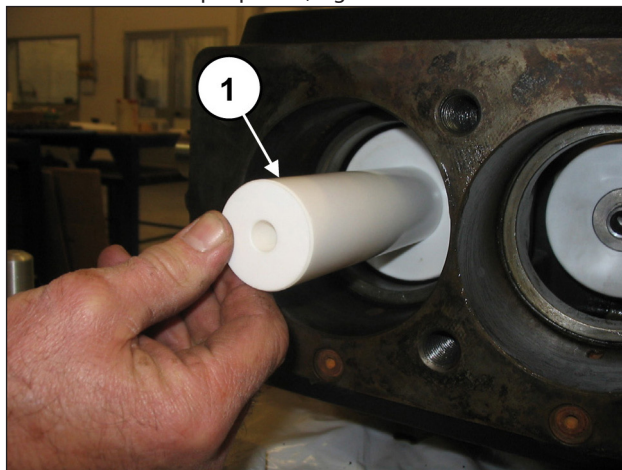

Fig. 137

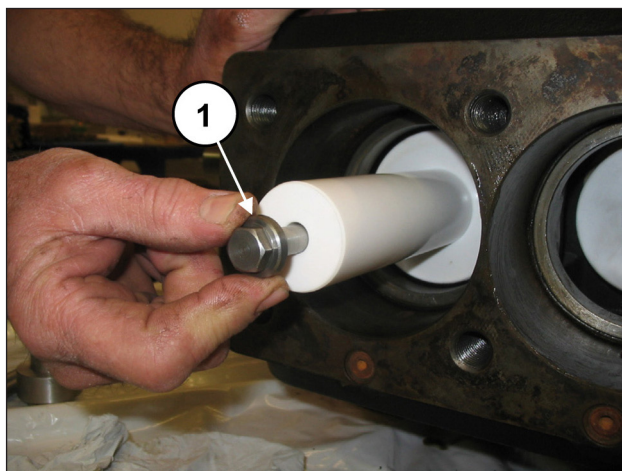

Fig. 138

Calibrate the screws with a torque wrench as indicated in chapter 3.

Insert the O-ring inside the pump casing (pos. ①, Fig. 139) and then the previously-assembled liner-seal support block (complete with the same O-ring) to end stroke (pos. ①, Fig. 140).

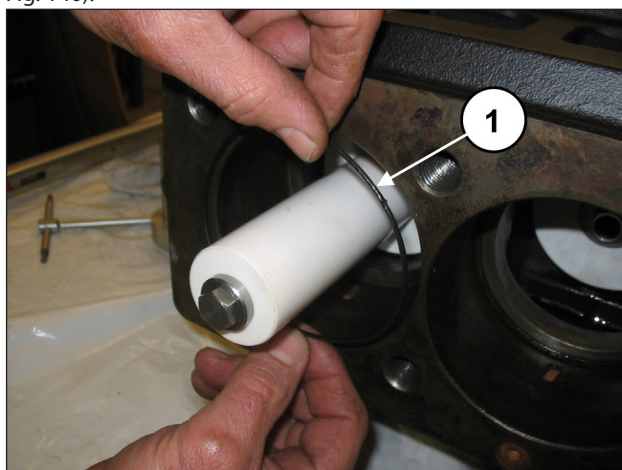

Fig. 139

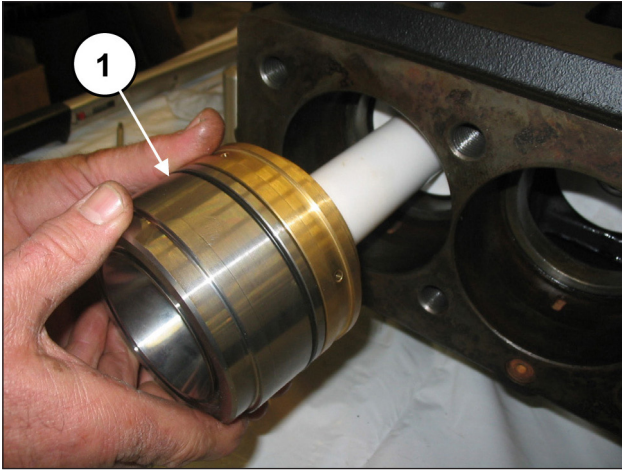

Fig. 140

Ensure that the liner-support block is positioned correctly down to the bottom of the housing (pos. ①, Fig. 141).

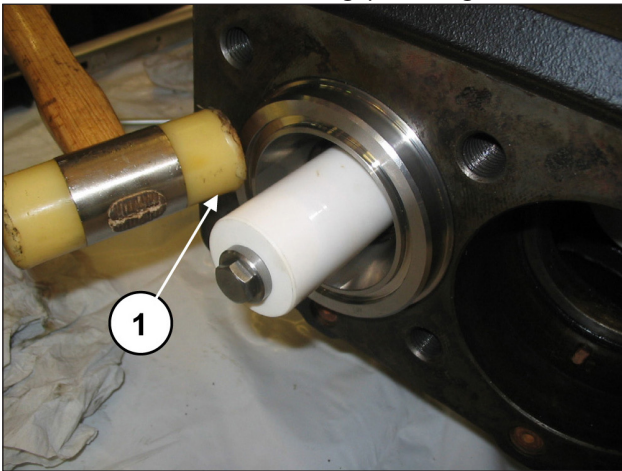

Fig. 141

Install the front O-ring in the liner (pos. ①, Fig. 142) and the recirculation hole O-ring (pos. ①, Fig. 143).

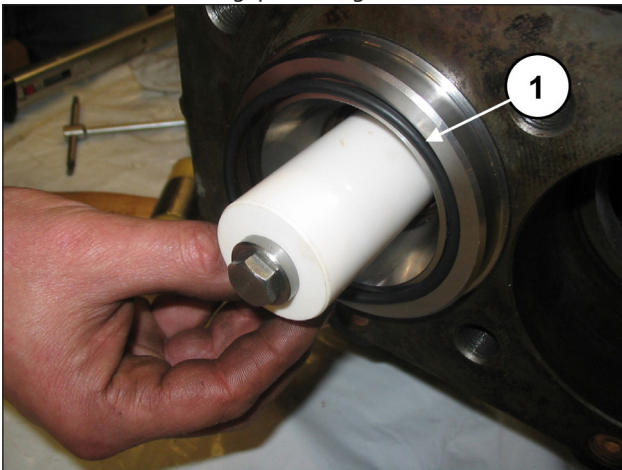

Fig. 142

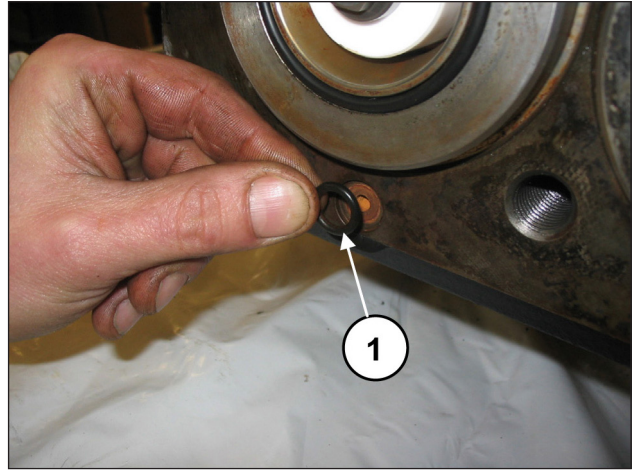

Fig. 143

Insert the O-ring on the inspection covers (pos. ①, Fig. 144) and assemble the covers with the use of 4+4 M6x14 screws (pos. ①, Fig. 145).

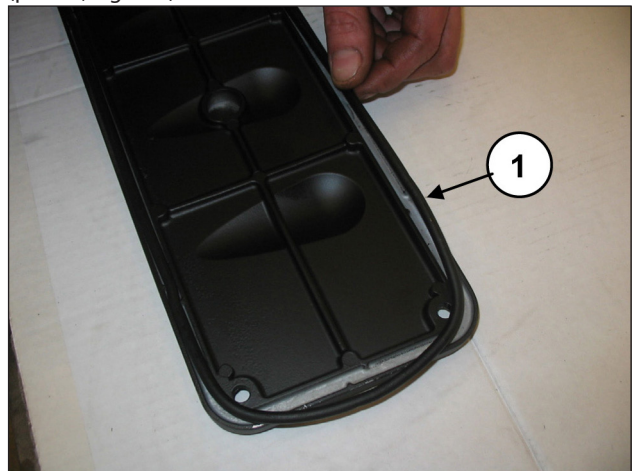

Fig. 144

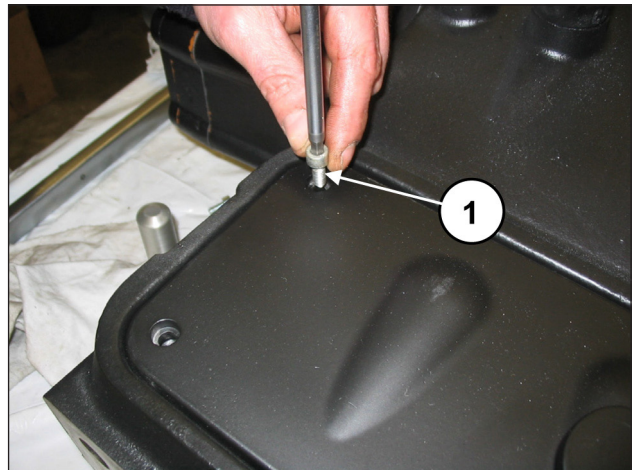

Fig. 145

Calibrate the screws with a torque wrench as indicated in chapter 3.

2.2.5 Recovering the heads

If the insides of the piston chambers on the head show clear signs of cavitation, due to incorrect pump feeding, it is possible to recover the damaged head and avoid the need to replace it.

In order to recover the head, perform the operations indicated in Fig. 146 for the versions with piston \varnothing 40-45-50 and indicated in Fig. 147 with piston \varnothing 55-60-65:

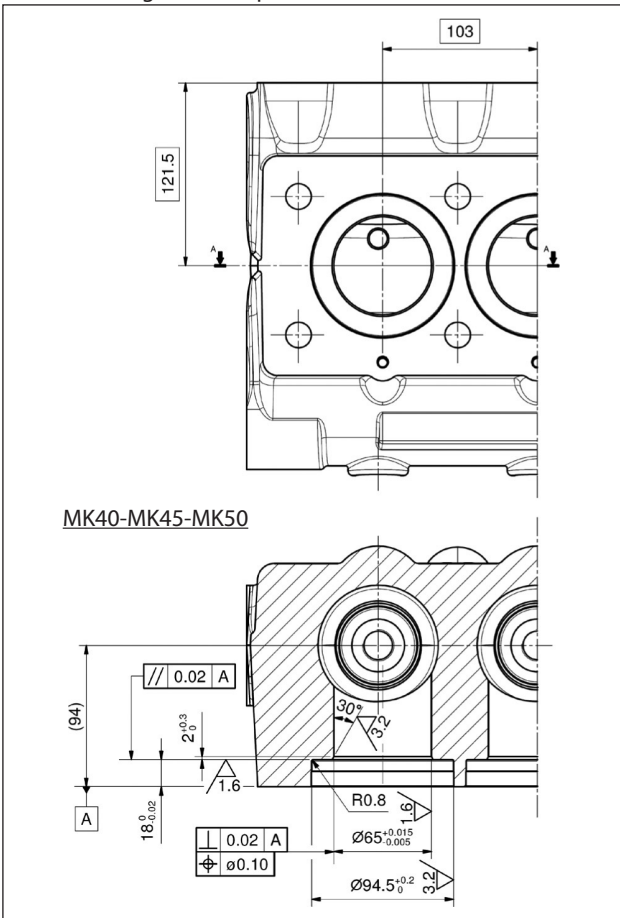

Fig. 146

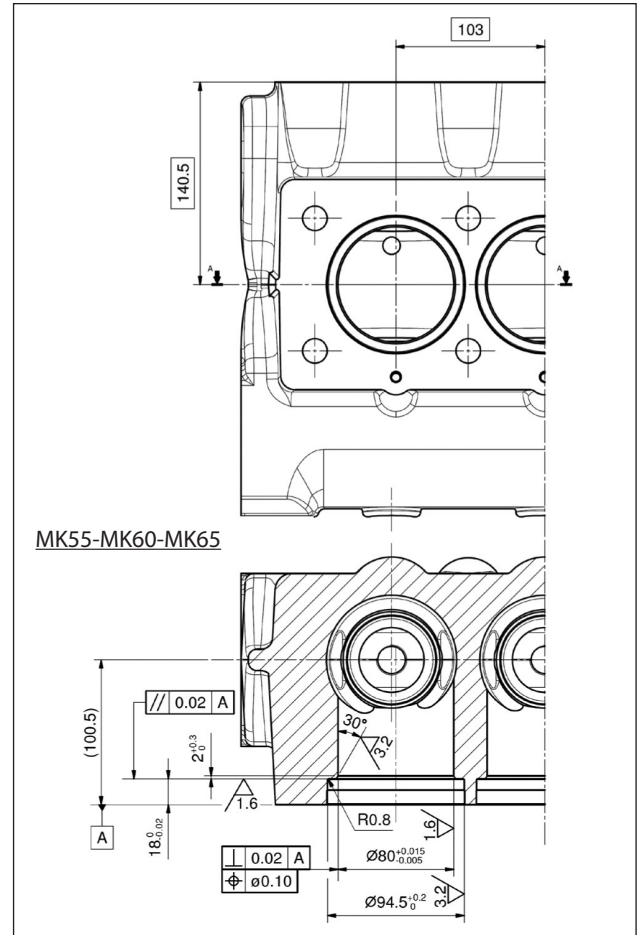

Fig. 147

The machined head must be assembled by driving in the bushes (pos. ①) together with the anti-extrusion rings (pos. ②) and O-rings (pos. ③) as shown in Fig. 148 for versions with piston \varnothing 40-45-50 and in Fig. 149 for versions with piston \varnothing 55-60-65:

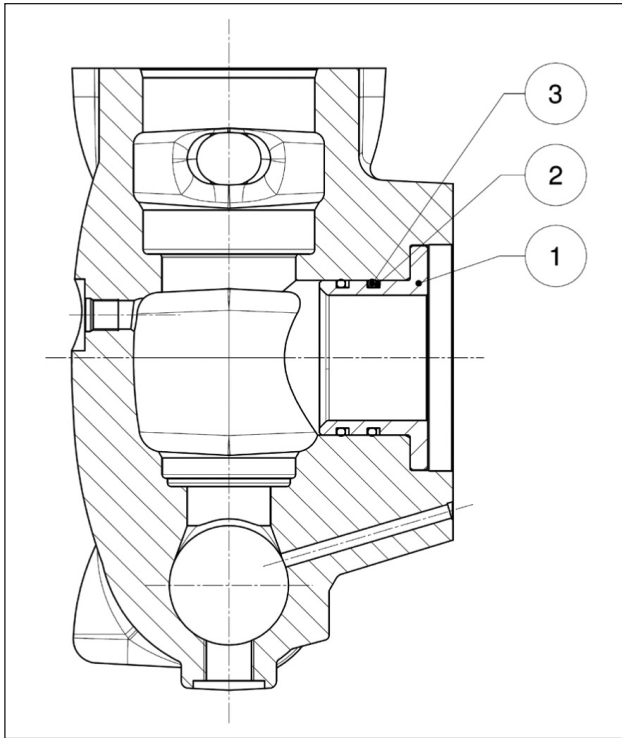

Fig. 148

- no. 1 - Bush for versions with piston Ø40-45-50 code 74215156 - qty 3
- no. 2 - Anti-extruder ring - code 90526880 - qty 6
- no. 3 - O-ring - code 90410200 - qty

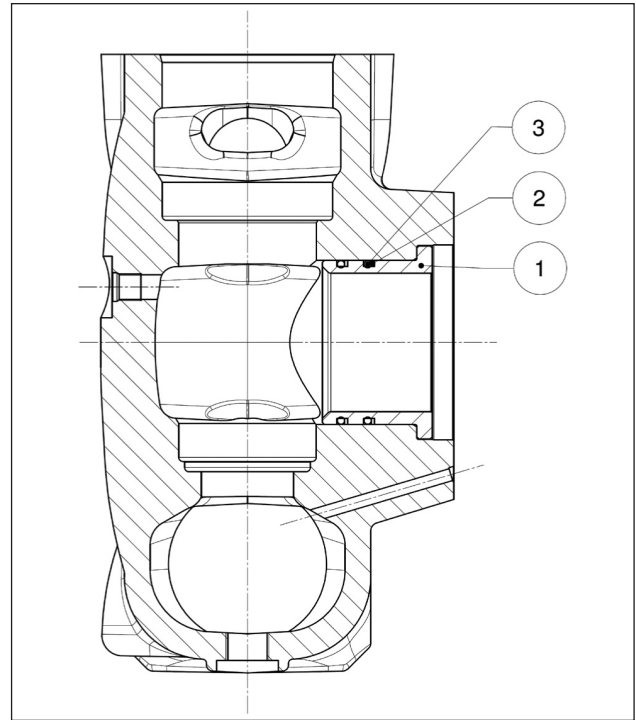

Fig. 149

- no. 1 - Bush for versions with piston Ø55-60-65 code 74215056 - qty 3
- no. 2 - Anti-extruder ring - code 90528500 - qty 6
- no. 3 - O-ring - code 90412900 - qty 6

3 SCREW TIGHTENING CALIBRATION

Screw tightening must only be performed with a torque wrench.

Description	Exploded Drawing Position	Tightening Torque Nm
Casing cover M8x18 screw	54	20
G1/2x13 casing plug	55	40
Reduction gear flange M8x18 screw	54	20
Reduction gear cover M10x50 screw	70	45
Ring gear stop M10x25 screw	65	45
Reduction gear box M12x40 screw	75	73.5
Reduction gear box M12x50 screw	64	73.5
Upper and lower cover M6x14 screw	41	10
Bearing cover M12x30 screw	90	40
M12x1.25x87 screw, connecting rod tightening	53	75*
Piston guide M6x20 screw	49	10
Oil seal cover M6x14 screw	41	10
M10x160 screw, piston attachment	27	40
M16x55 screw, valve cover	26	333
G1/4"x13 head plug	13	40
Head M16x180 screw	25	333**
Valve opening device	2	40

* Achieve coupling torque tightening screws at the same time

** Tighten the screws starting crosswise from the 4 inner screws (see Fig. 108), to then continue with the 4 outer screws, always tightening crosswise.

4 REPAIR TOOLS

Pump maintenance can be carried out with simple component disassembly and reassembly tools. The following tools are available:

For assembly:

Piston guide oil seal	code 27910900
Pinion oil seal	code 27515900
	code 27548200
Outlet valve seat O-ring for versions with piston Ø40-45-50	code 27516000
Outlet valve seat O-ring for versions with piston Ø55-60-65	code 27516100

For disassembly:

Inlet valve seat for versions with piston Ø40-45-50	code 27516200
Inlet valve seat for versions with piston Ø55-60-65	code 27516300
Outlet valve seat	code 27516400
Oil seal cover	code 27516400
	code 27516500
Liner block + seals support	code 27516600
Reduction gear cover	code 27516700
Shaft (con-rod interlocking)	code 27566200

5 REPLACING THE CON-ROD FOOT BUSH

Perform cold-driving of the bushing and the subsequent work bearing in mind the dimensions and tolerances shown in Fig. 150 below.

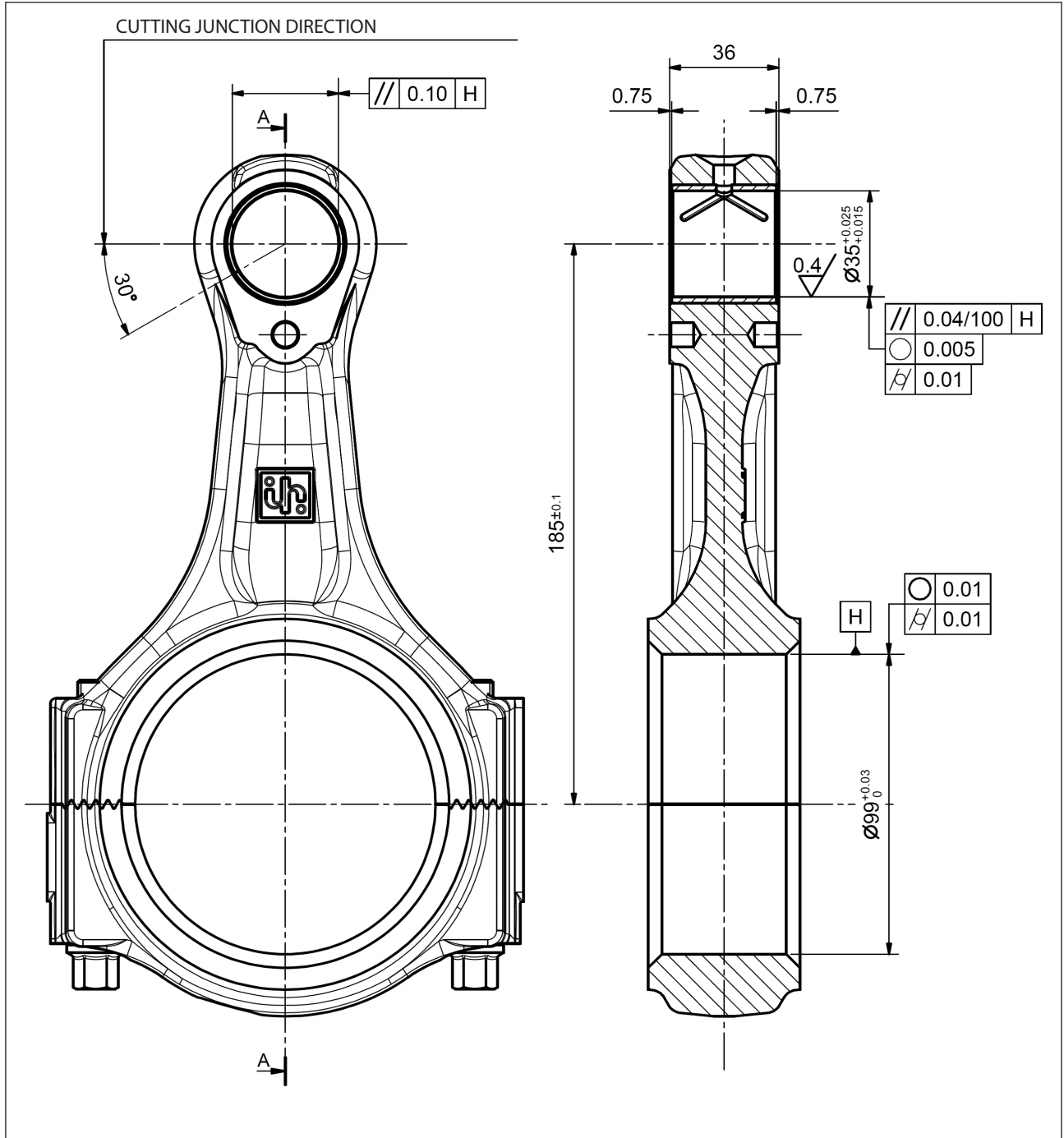

Fig. 150

6 SPECIAL VERSIONS

The instructions for repairing special versions are given below. Unless specified otherwise, refer to the information above for the standard MK-MKS pump.

- MKC - MKSC pumps: for repair, follow the instructions for the standard MK-MKS pump.
- MKR - MKSR pumps: for repair, follow the instructions for the standard MK pump with the exception of the pressure seals, for which it is necessary to follow the paragraphs below.

6.1 DISASSEMBLY OF THE PISTON UNIT – SUPPORTS – SEALS

The piston unit requires preventive checks as indicated in the preventive maintenance table in the **Use and maintenance manual**.

Maintenance is limited to visual inspection of any drainage from the hole present on the lower cover. If abnormalities / variations on the outlet pressure gauge or dripping from the drainage hole circuit are detected, the seal pack will have to be checked and replaced.

Proceed as follows to remove the piston units:

To access the piston unit, unscrew the M16x180 screws and remove the head.



Remove the head taking care to avoid hitting the pistons.

Disassemble pistons unscrewing the fixing screws (pos. ①, Fig. 151).

Remove the piston from the seal support and check that its surfaces do not present any scratches, signs of wear or cavitation.

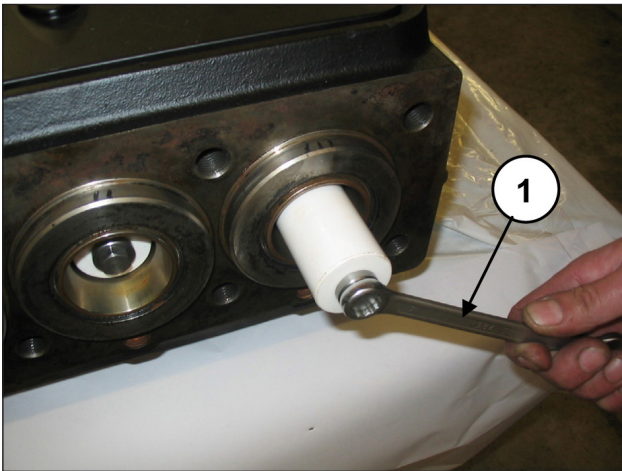

Fig. 151

Remove the upper inspection cover, unscrewing the 4 fixing screws (pos. ①, Fig. 152).

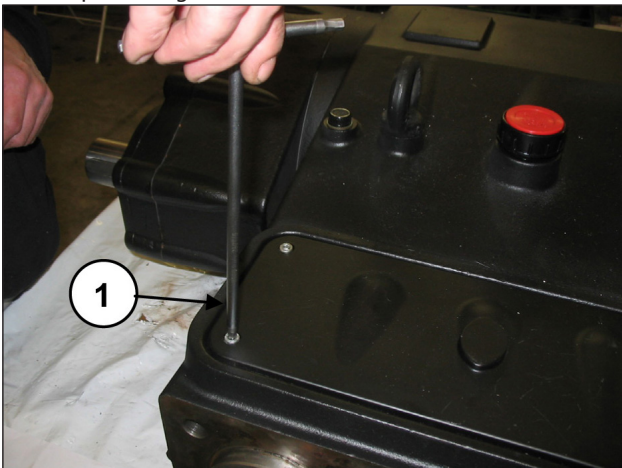

Fig. 152

Manually turn the shaft in such a way to bring the 3 pistons progressively to the top dead centre position and insert the buffer tool code 27516600 between the piston guide and the piston (pos. ①, Fig. 153).

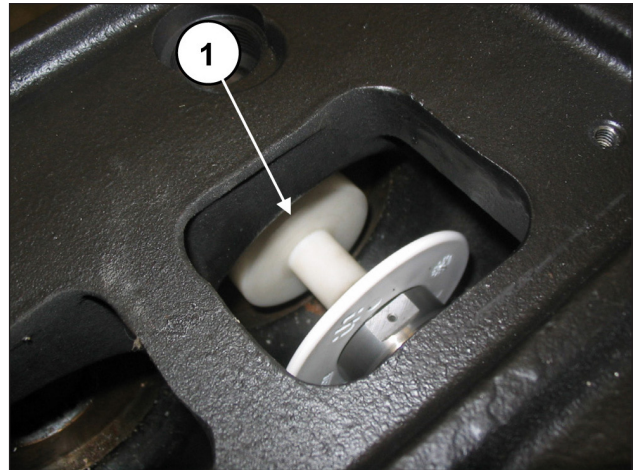

Fig. 153

Turning the shaft, have the piston guide move forward so that the buffer, moving ahead, can expel the seal support, the spring and the entire piston unit (pos. ①, Fig. 154).

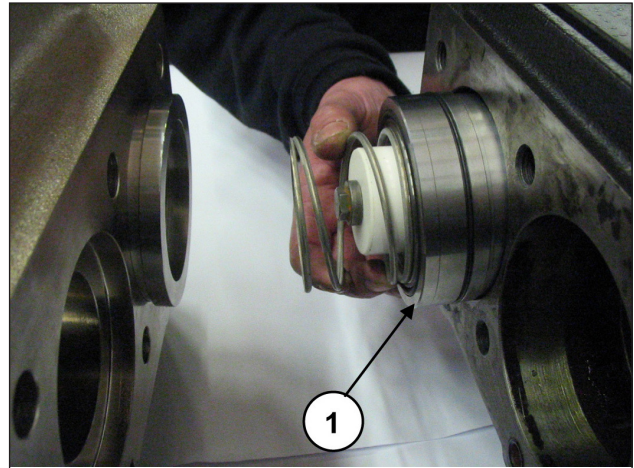

Fig. 154

Extract the seal support unit and the buffering tool. Remove the seal support bottom O-ring should it remain inside the pump casing (pos. ①, Fig. 155).

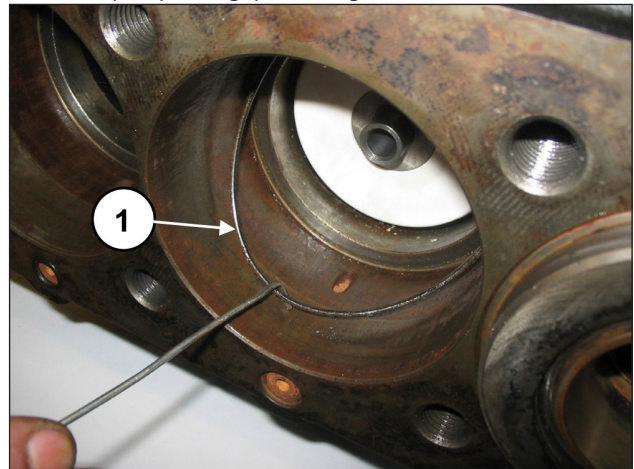

Fig. 155

Slip the spray-guard rings off the piston heads (pos. ①, Fig. 156).

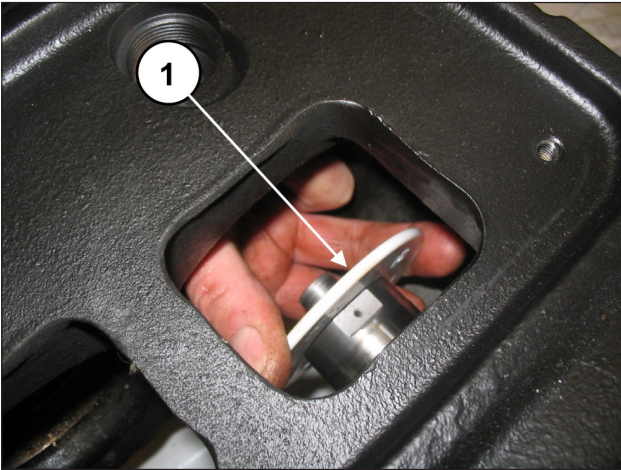

Fig. 156

If you need to replace the piston guide seal ring, you need to remove the oil seal cover as follows:
Unscrew the two screws locking the oil seal cover (pos. ①, Fig. 157).

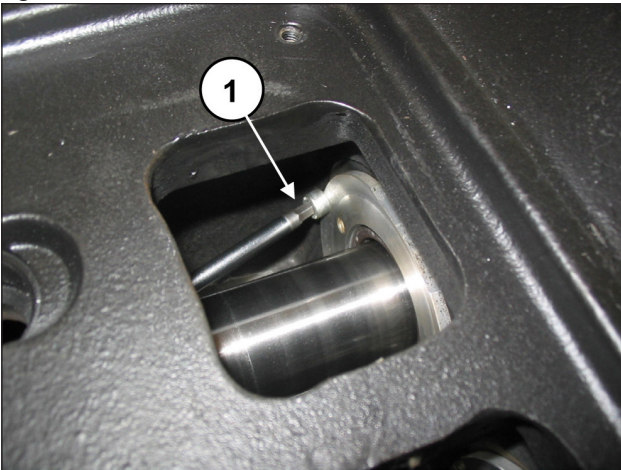

Fig. 157

Position the piston guide at bottom dead centre, screw the extractor code 27516400 including the M5 adapter code 27516500 in the holes in the cover (pos. ①, Fig. 158) and remove the oil seal cover from the pump assembly (pos. ①, Fig. 159).

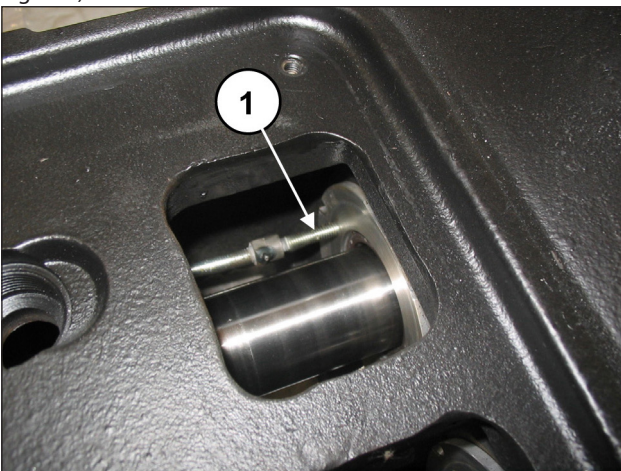

Fig. 158

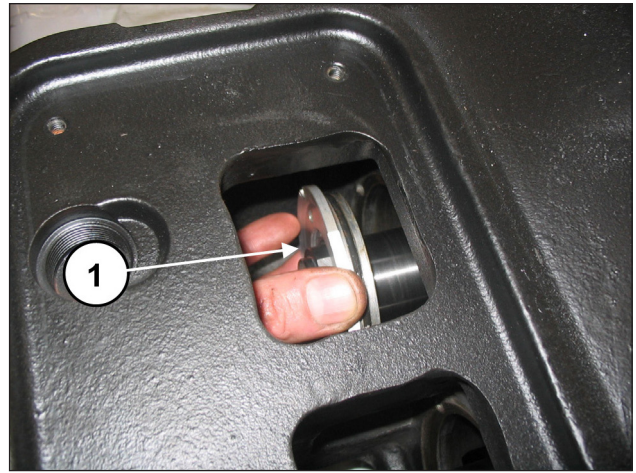

Fig. 159

Replace the oil seal (pos. ①, Fig. 160) and the outside O-ring (pos. ②, Fig. 160).

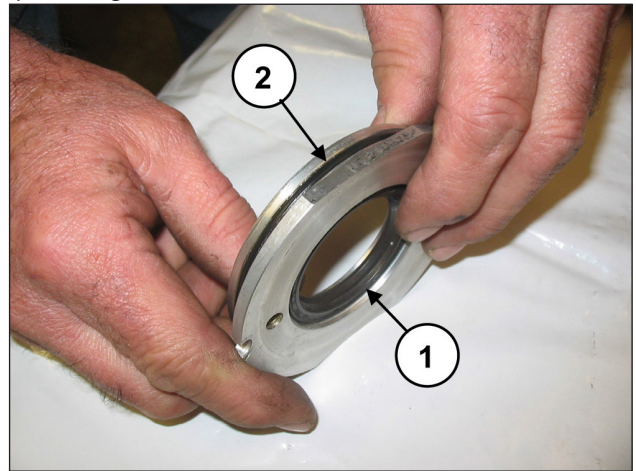

Fig. 160

Separate the seal support from the liner, remove the spring ring and scraper ring (pos. ①②, Fig. 161) to access the pressure seals (pos. ①, Fig. 162).

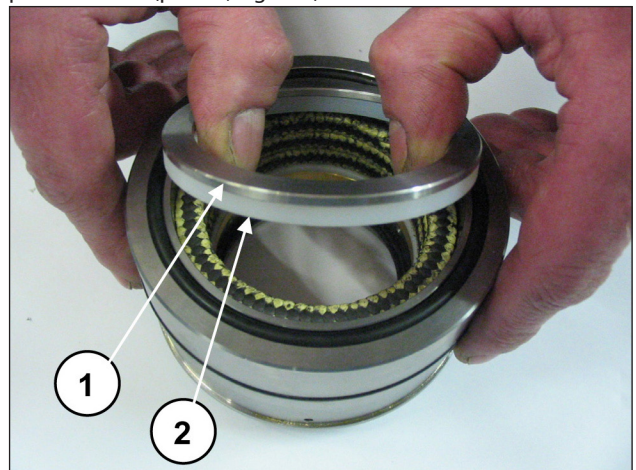

Fig. 161

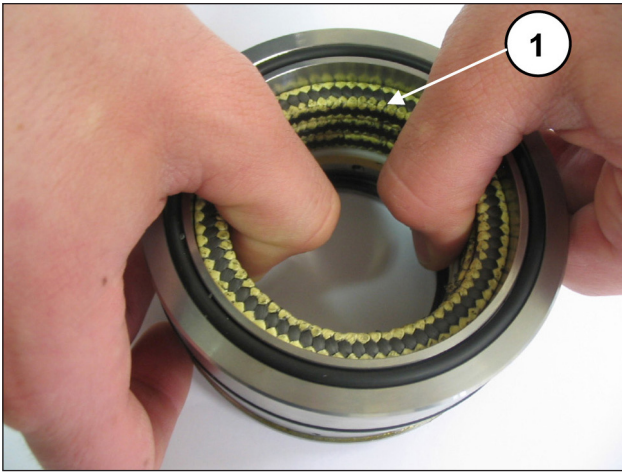

Fig. 162

To remove the low pressure seal, use a thickness gauge or another tool which will not damage the seal support housing (pos. ①, Fig. 163).

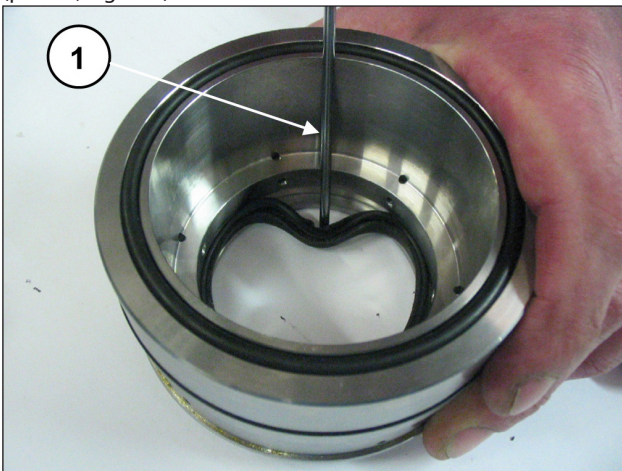

Fig. 163

6.2 ASSEMBLING THE PISTON UNIT – SUPPORTS – SEALS

Proceed with reassembly following the reverse order indicated in par. 6.1.



Replace the pressure seals moistening the lips with silicone grease (without spreading it), taking extra care not to damage them during liner insertion.



The O-rings and the pressure seals must be replaced at each disassembly.

Insert the low pressure seal in the packing support (pos. ①, Fig. 164) taking care to choose the direction of assembly where the seal lip is facing forwards (towards the head) and the O-ring (pos. ②, Fig. 164).

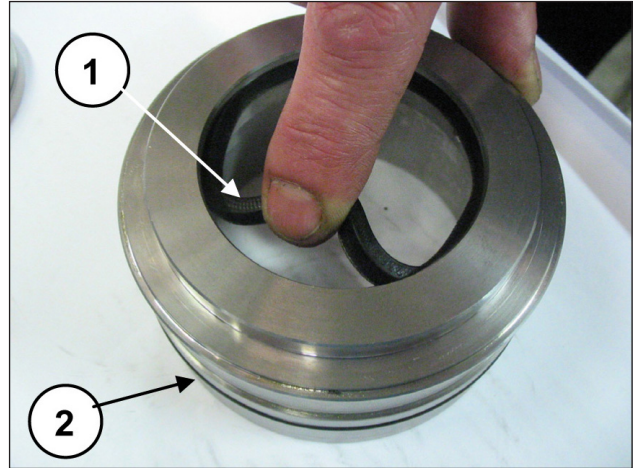

Fig. 164

Assemble the support ring and the anti-extrusion ring (pos. ①②, Fig. 165), the three packings making sure the notches are at 120° from each other (pos. ①, Fig. 166), the packing scraper ring and the spring ring (pos. ①②, Fig. 167).

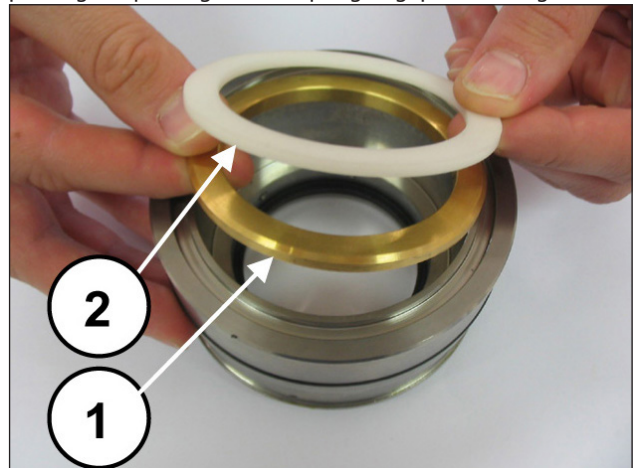

Fig. 165

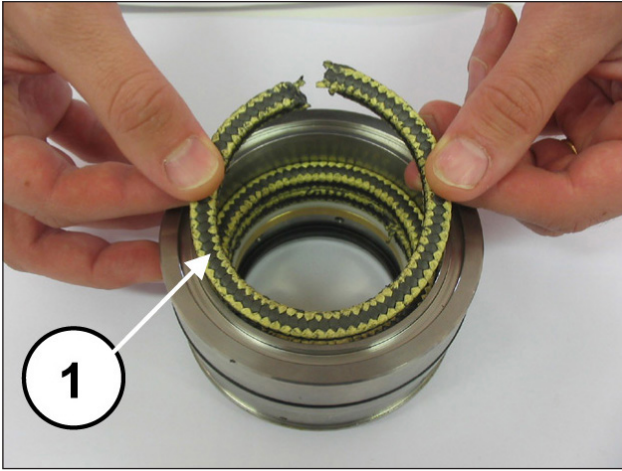

Fig. 166

Mount the oil seal in the oil seal cover (pos. ①, Fig. 169) using a buffer code 27910900.

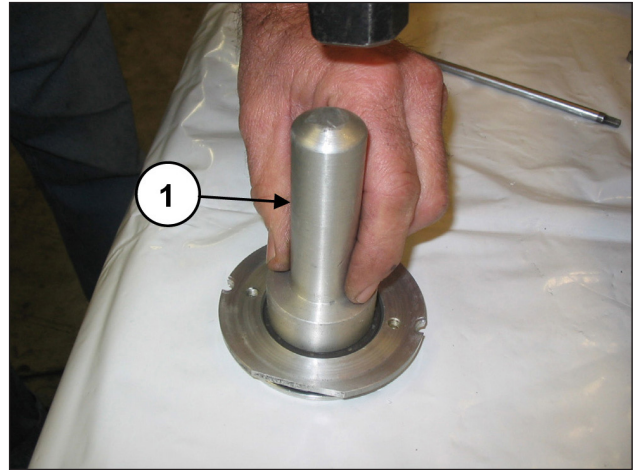

Fig. 169

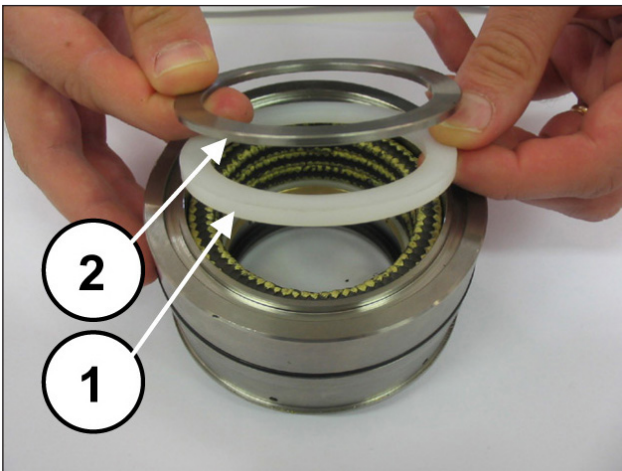

Fig. 167

Position the O-ring (pos. ①, Fig. 170) in the seat of the oil seal cover and insert the assembly mounted in the casing into the seat (pos. ①, Fig. 171).

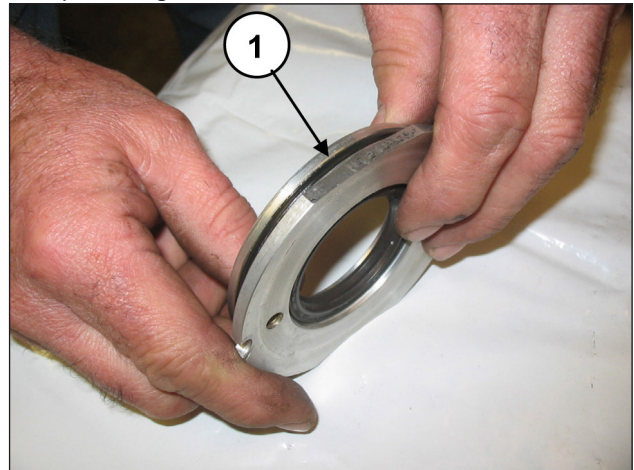

Fig. 170

Now assemble the O-ring (pos. ①, Fig. 168) on the packing head ring and position it in the seat on the head.

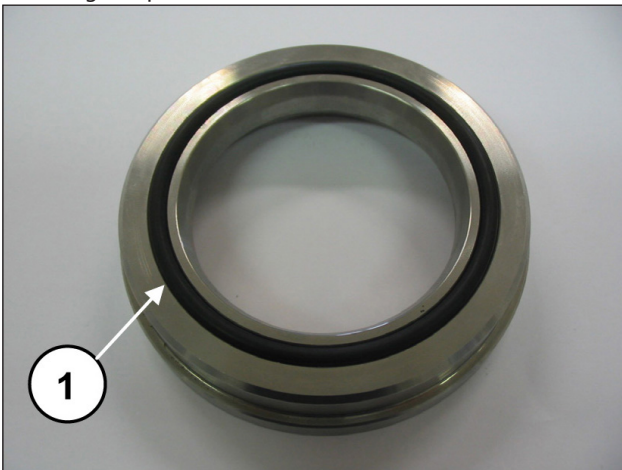

Fig. 168

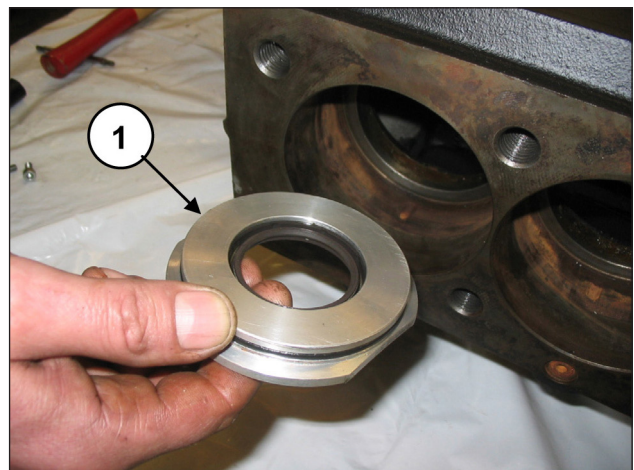

Fig. 171

Make sure that the cover completely enters its seat (pos. ①, Fig. 172) being careful not to damage the lip of the seal ring. Screw in the oil seal covers using 2 x M6x14 screws (pos. ①, Fig. 173).

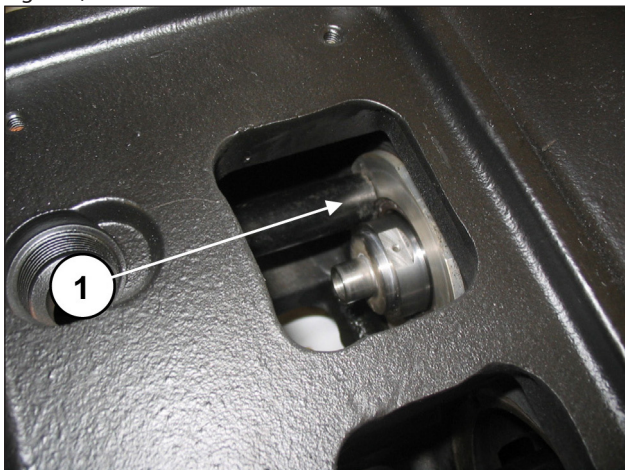

Fig. 172

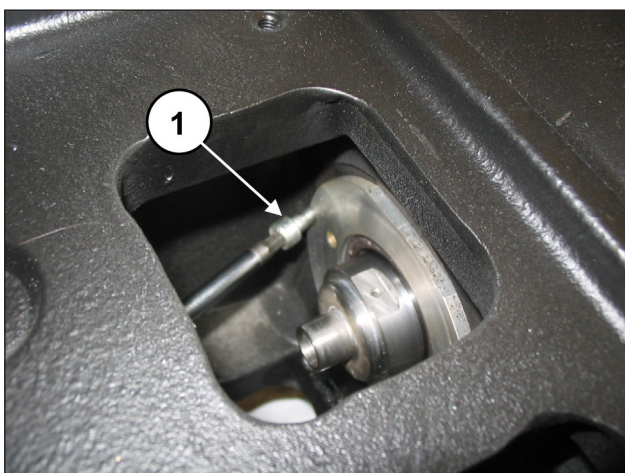

Fig. 173

Calibrate the screws with a torque wrench as indicated in chapter 3.
Position the spray-guard together with the O-ring in the housing on the piston guide (pos. ①, Fig. 174 and Fig. 175).

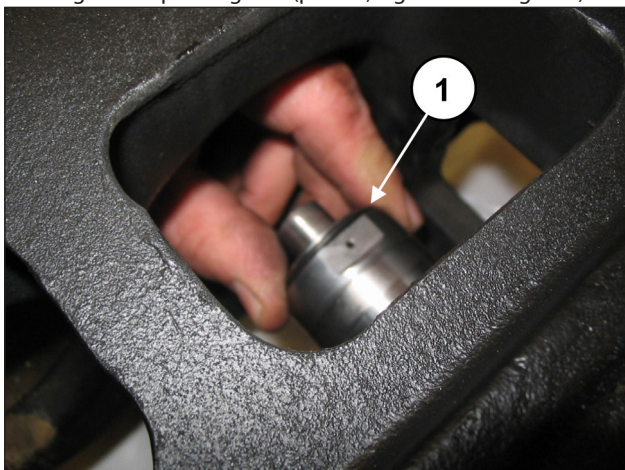

Fig. 174

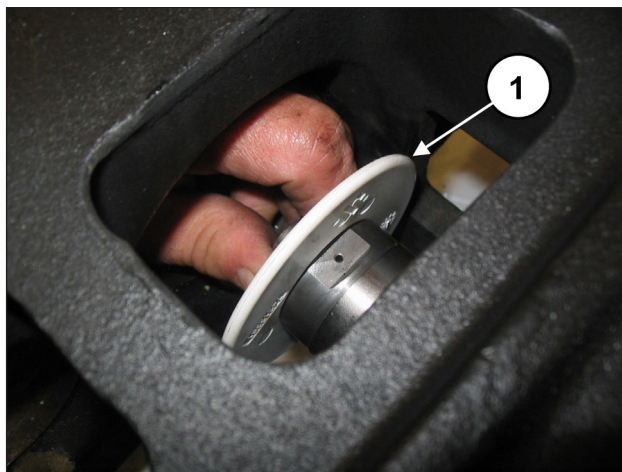

Fig. 175

Insert the $\varnothing 10 \times 18 \times 0.9$ washer in the piston fixing screw (pos. ①, Fig. 176).

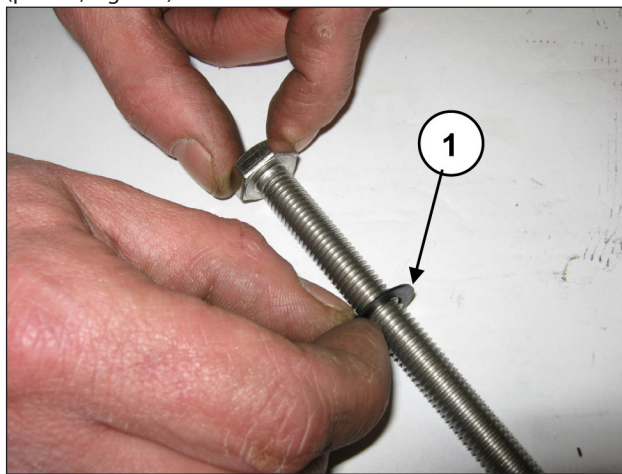

Fig. 176

Install the pistons on their respective guides (pos. ①, Fig. 177) and fasten them as per pos. ①, Fig. 178.

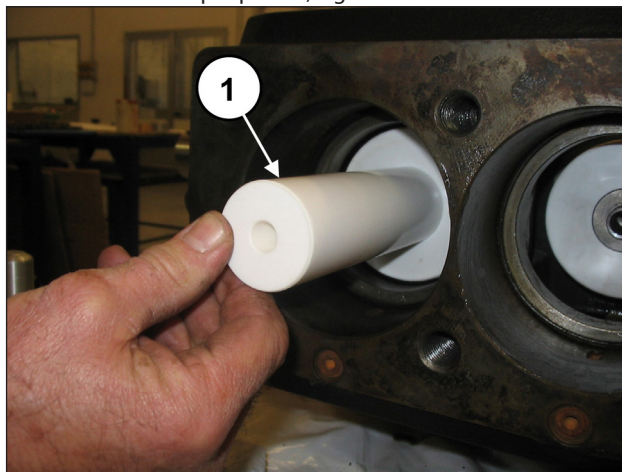

Fig. 177

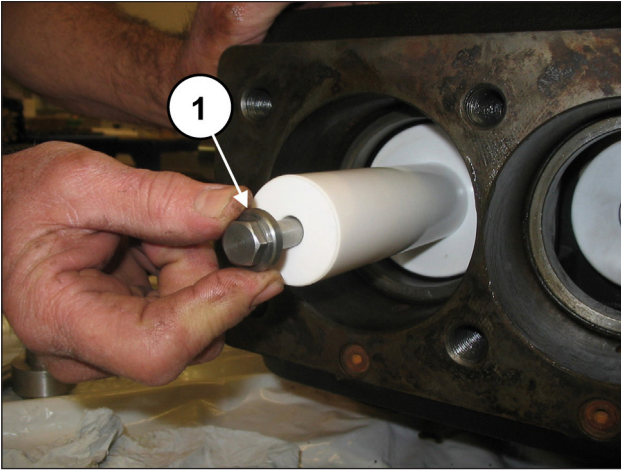

Fig. 178

Calibrate the screws with a torque wrench as indicated in chapter 3.
 Insert the O-ring inside the pump casing (pos. ①, Fig. 179) and then the previously-assembled liner-seal support block (complete with the same O-ring) to end stroke (pos. ①, Fig. 180).

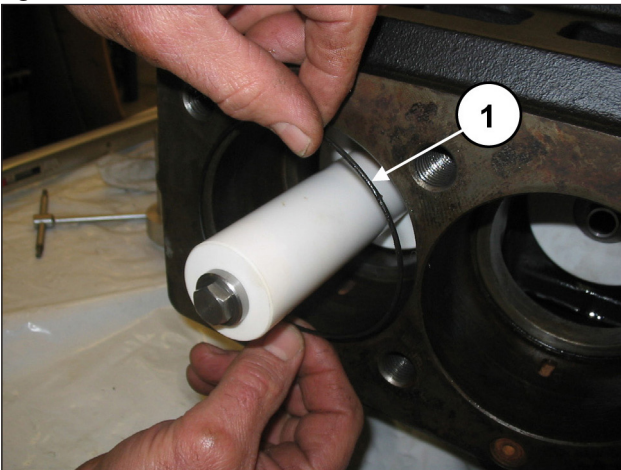

Fig. 179

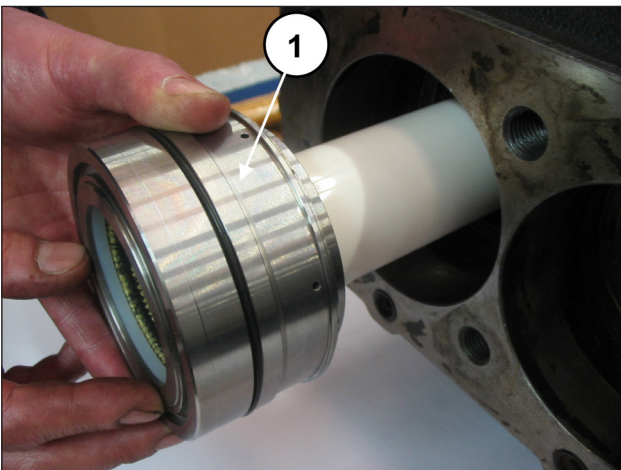

Fig. 180

Ensure that the liner-support block is positioned correctly down to the bottom of the housing (pos. ①, Fig. 181); now mount the front O-ring of the liner and the spring (pos. ①②, Fig. 182).

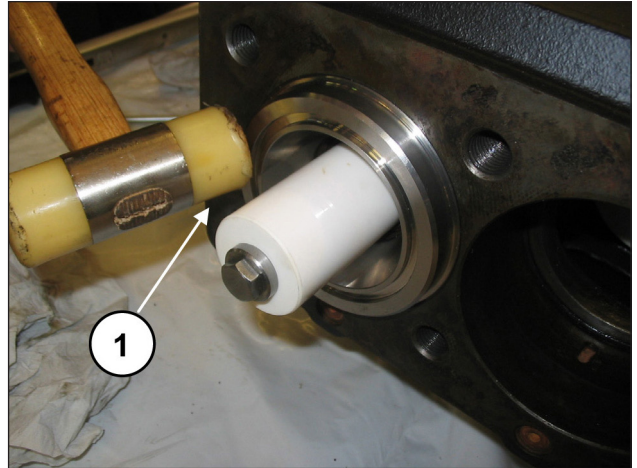

Fig. 181

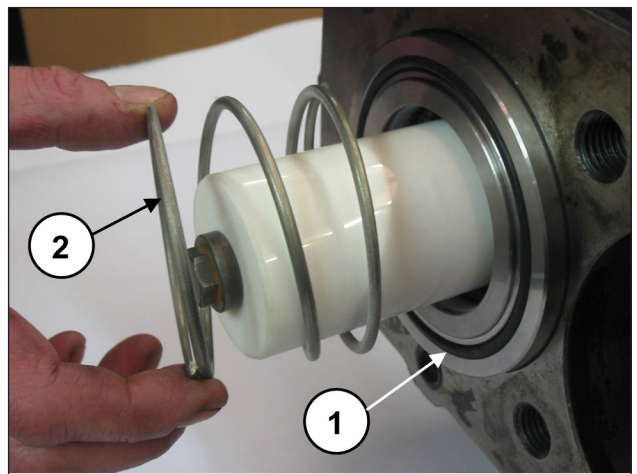

Fig. 182

Mount the recirculation hole O-ring (pos. ①, Fig. 183).
Facilitate keeping the O-rings in place with a light smearing of grease.

Fig. 184 shows subsequent assembly of the head.

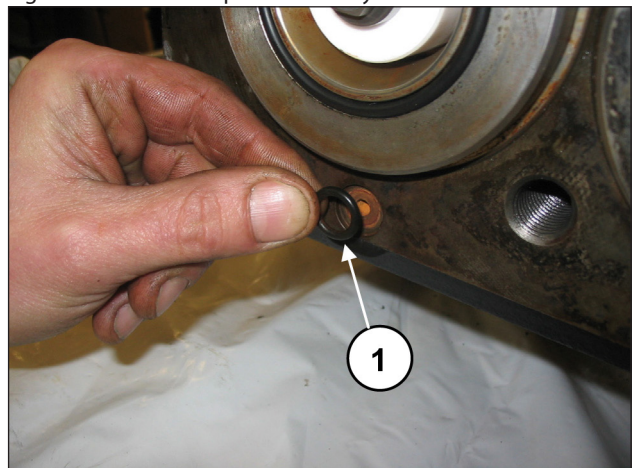

Fig. 183

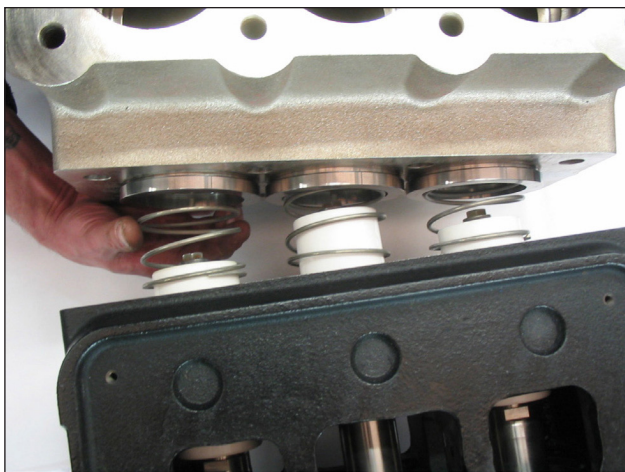

Fig. 184

Insert the O-ring on the inspection covers (pos. ①, Fig. 185) and assemble the covers with the use of 4+4 M6x14 screws (pos. ①, Fig. 186).

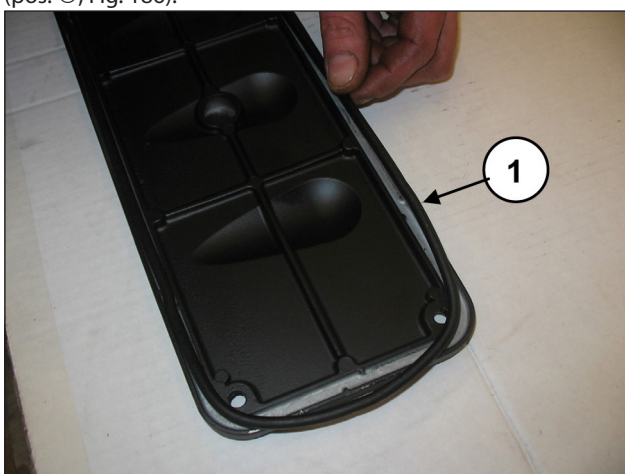

Fig. 185



Fig. 186

Calibrate the screws with a torque wrench as indicated in chapter 3.

Sommaire

1	INTRODUCTION	79
1.1	DESCRIPTION DES SYMBOLES	79
2	CONSIGNES DE RÉPARATION	79
2.1	RÉPARATION DE LA PARTIE MÉCANIQUE.....	79
2.1.1	<i>Démontage de la partie mécanique.....</i>	79
2.1.2	<i>Montage de la partie mécanique.....</i>	86
2.1.3	<i>Classes de majorations prévues</i>	93
2.2	RÉPARATION DE LA PARTIE HYDRAULIQUE	93
2.2.1	<i>Désassemblage de la tête - groupes des soupapes.....</i>	93
2.2.2	<i>Remontage de la tête - ensembles de soupapes</i>	95
2.2.3	<i>Démontage du groupe piston - supports - joints d'étanchéité</i>	99
2.2.4	<i>Montage du groupe piston - supports - joints d'étanchéité</i>	101
2.2.5	<i>Récupération des têtes.....</i>	105
3	FORCES DE SERRAGE DES VIS	106
4	OUTILS POUR LA RÉPARATION	107
5	REMPLACEMENT DE LA DOUILLE PIED DE LA BIELLE	107
6	VERSIONS SPÉCIALES	108
6.1	DÉMONTAGE DU GROUPE PISTON - SUPPORTS - JOINTS D'ÉTANCHÉITÉ	108
6.2	MONTAGE DU GROUPE PISTON - SUPPORTS - JOINTS D'ÉTANCHÉITÉ	110

1 INTRODUCTION

Ce manuel décrit les instructions pour la réparation des pompes de la série MK et doit être attentivement lu et compris avant d'effectuer et de réaliser toute intervention sur la pompe.

Le bon fonctionnement et la durée de la pompe dépendent de l'usage correct et de l'entretien approprié effectué sur celle-ci.

Interpump Group décline toute responsabilité concernant les dommages causés par négligence et inobservation des consignes décrites dans ce manuel.

1.1 DESCRIPTION DES SYMBOLES

Lire attentivement ce qui est indiqué dans ce manuel avant de commencer toute opération.



Signal de Mise en garde



Lire attentivement ce qui est indiqué dans ce manuel avant de commencer toute opération.



Signal de Danger

S'équiper de lunettes de protection.



Signal de Danger

S'équiper de gants de protection avant chaque opération.

2 CONSIGNES DE RÉPARATION



2.1 RÉPARATION DE LA PARTIE MÉCANIQUE

Les opérations de réparation de la partie mécanique doivent être effectuées après avoir éliminé l'huile du carter.

Pour vidanger l'huile, retirer le bouchon de remplissage rep. ①, Fig. 1 puis le bouchon de vidange rep. ②, Fig. 1.

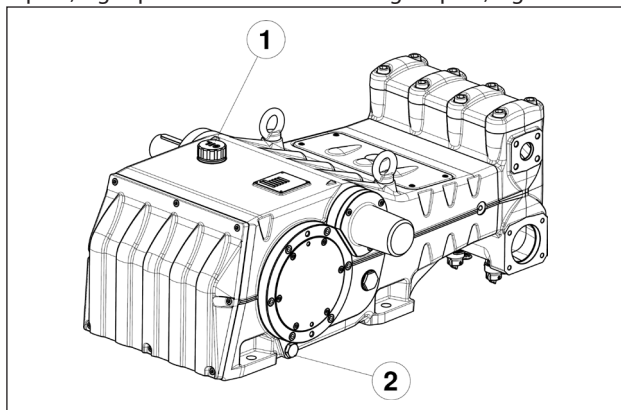

Fig. 1



Verser l'huile usagée dans un récipient spécial et l'éliminer auprès des centres autorisés. Elle ne doit en aucun cas être déversée dans l'environnement.

2.1.1 Démontage de la partie mécanique

La séquence correcte est la suivante :

Vidanger l'huile de la pompe et déposer la languette de l'arbre (rep. ①, Fig. 2).

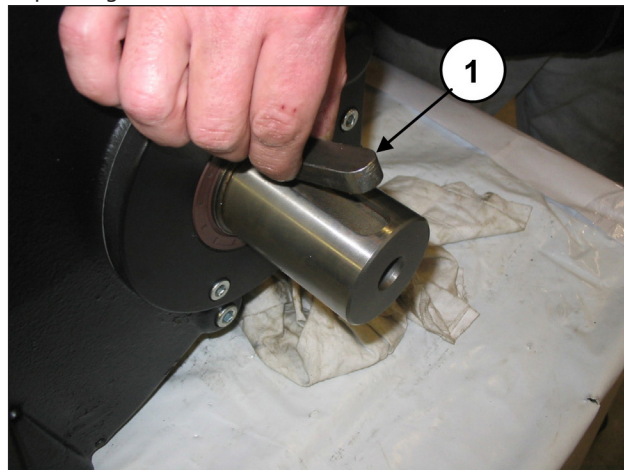

Fig. 2

Dévisser les vis de fixation du flasque du réducteur (rep. ①, Fig. 3) et dégager le flasque de l'arbre.

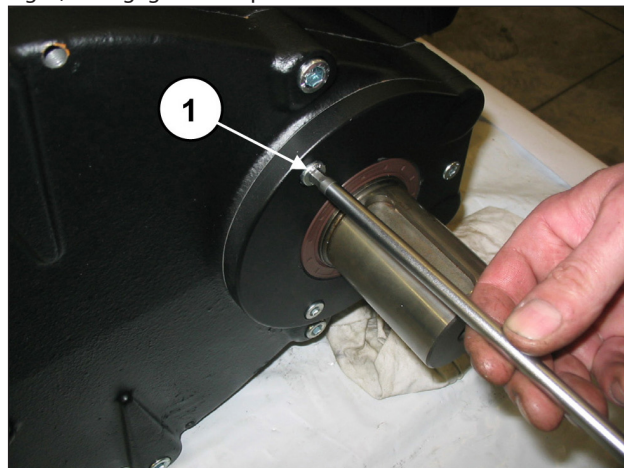

Fig. 3

De l'autre côté, dévisser les vis de fixation du couvercle du coussinet (rep. ①, Fig. 4) et le déposer.

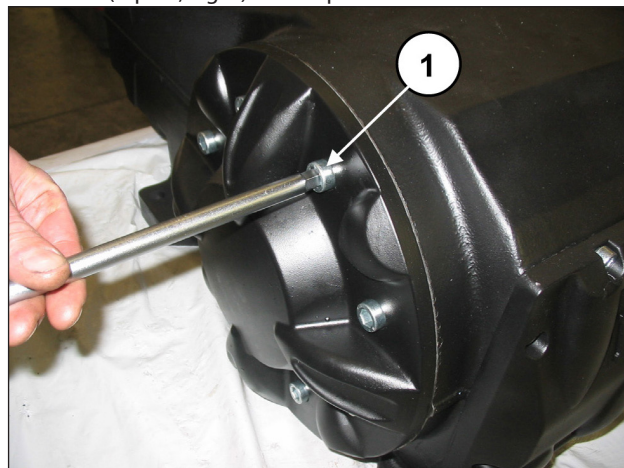

Fig. 4

Démonter ensuite le couvercle du carter en dévissant les vis correspondantes (rep. ①, Fig. 5).

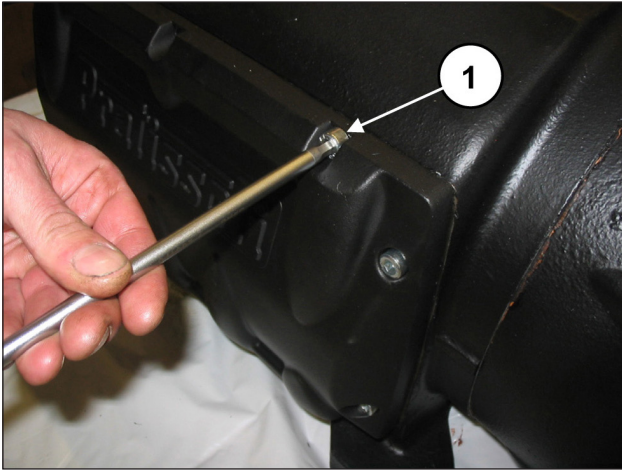

Fig. 5

Dévisser les vis de fixation du couvercle du réducteur (rep. ①, Fig. 6).

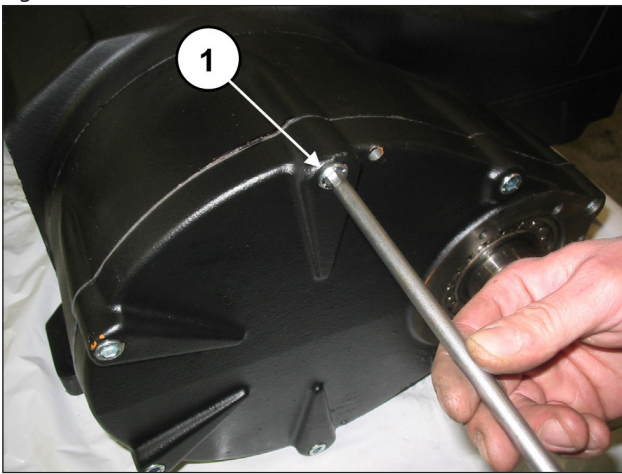

Fig. 6

Placer 3 goujons ou vis filetés M8 (rep. ①, Fig. 7) faisant office d'extracteurs, dans les orifices prévus à cet effet et deux vis M10 suffisamment longues servant à soutenir le couvercle (rep. ②, Fig. 7).

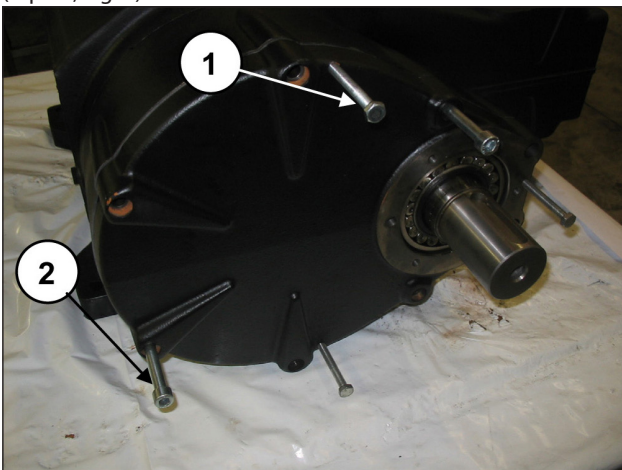

Fig. 7

Visser les 3 goujons filetés (rep. ①, Fig. 8) faisant office d'extracteurs et utiliser simultanément l'outil (réf. 27516700) pour frapper dessus de sorte que le coussinet reste sur le pignon durant l'extraction du couvercle (rep. ①, Fig. 9).

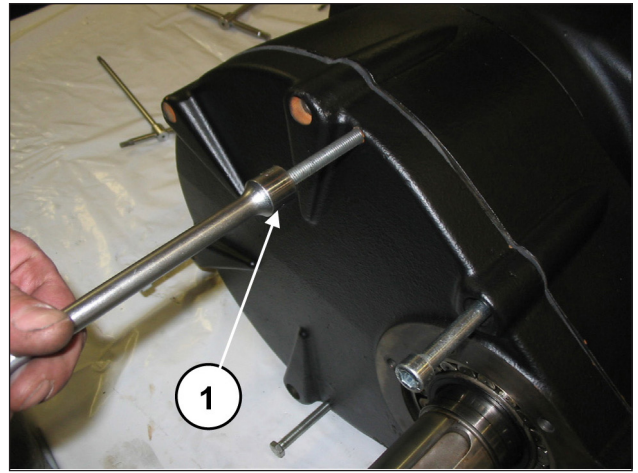

Fig. 8

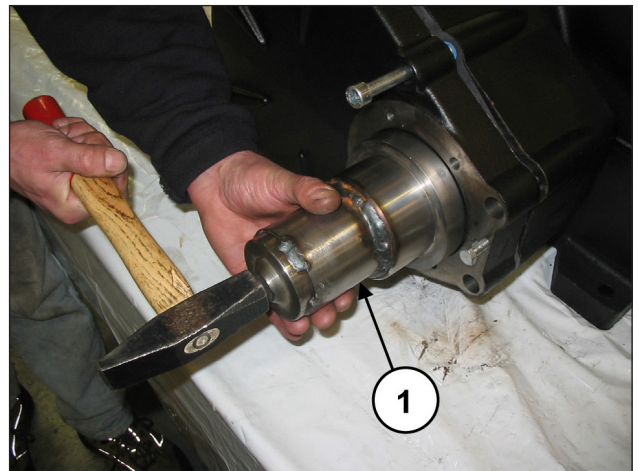

Fig. 9

Une fois l'opération terminée, déposer le couvercle du réducteur puis dégager le coussinet du pignon. Dévisser les vis de fixation du dispositif de retenue de la couronne (rep. ①, Fig. 10) et le déposer (rep. ①, Fig. 11).

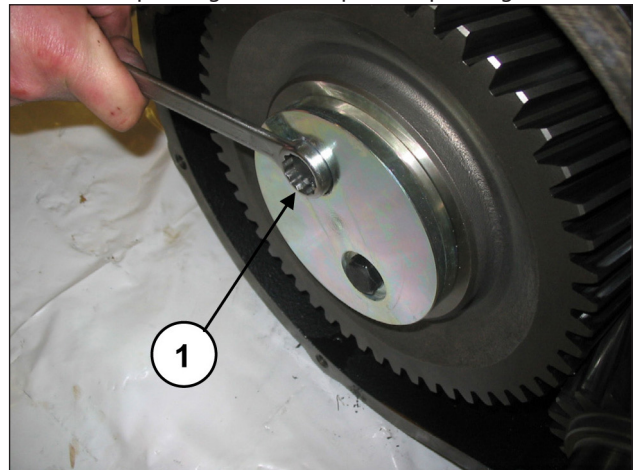

Fig. 10

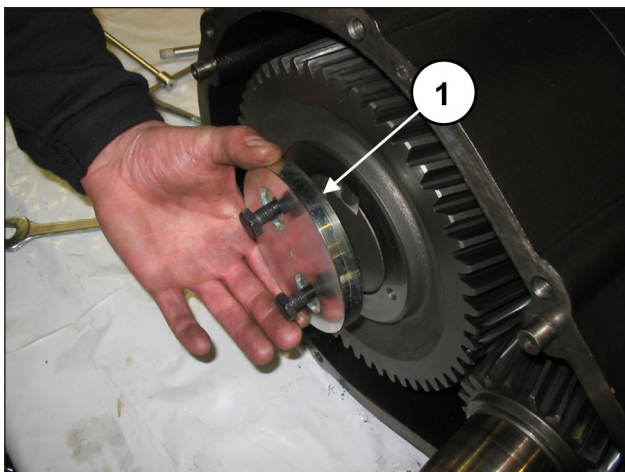

Fig. 11

Déposer la couronne (rep. ①, Fig. 12). Si nécessaire, il est possible d'utiliser un chasoir à inertie à appliquer aux 2 orifices M8 (rep. ②, Fig. 12).

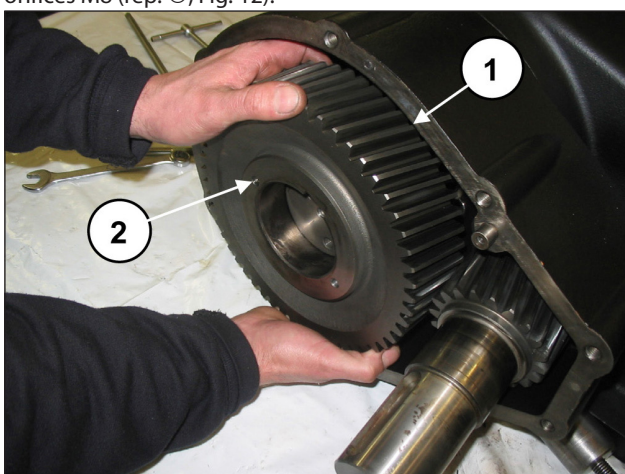

Fig. 12

Déposer la languette de l'arbre (rep. ①, Fig. 13).

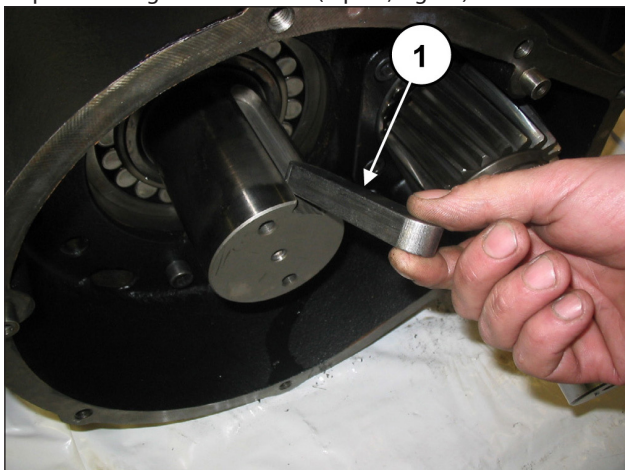

Fig. 13

Déposer le pignon à l'aide d'un chasoir à inertie à appliquer sur l'orifice M14 (rep. ①, Fig. 14).

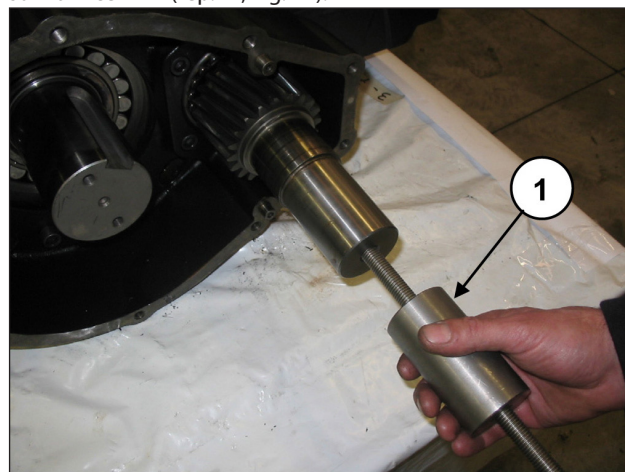

Fig. 14

Soulever la languette de la rondelle de sécurité (rep. ①, Fig. 15).

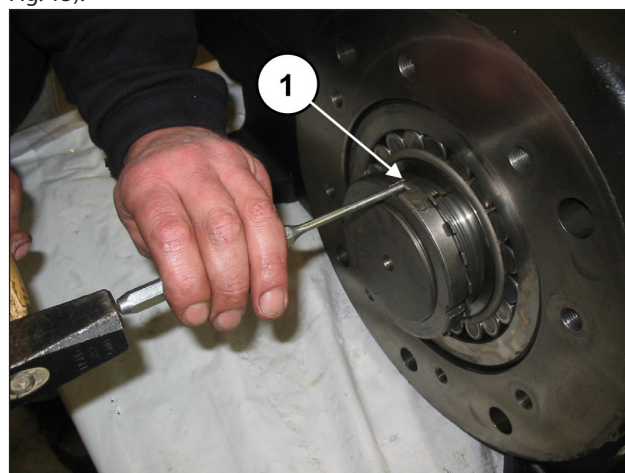

Fig. 15

Insérer une cale sous la bielle pour empêcher l'arbre de tourner (rep. ①, Fig. 16).

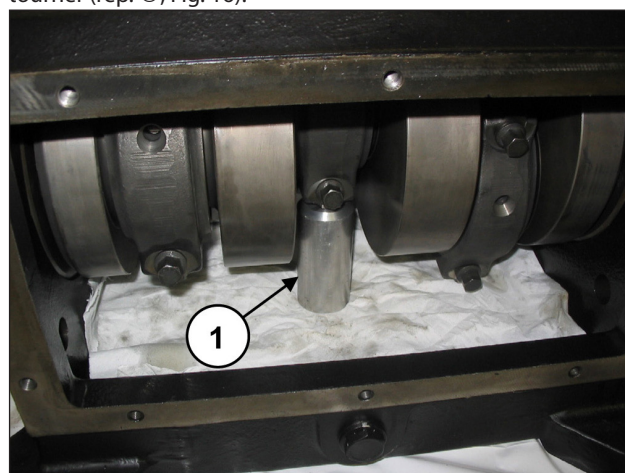

Fig. 16

Utiliser une clé appropriée pour dévisser la bague de blocage (rep. ①, Fig. 17) puis déposer la bague et la rondelle de sécurité (rep. ①, Fig. 18).

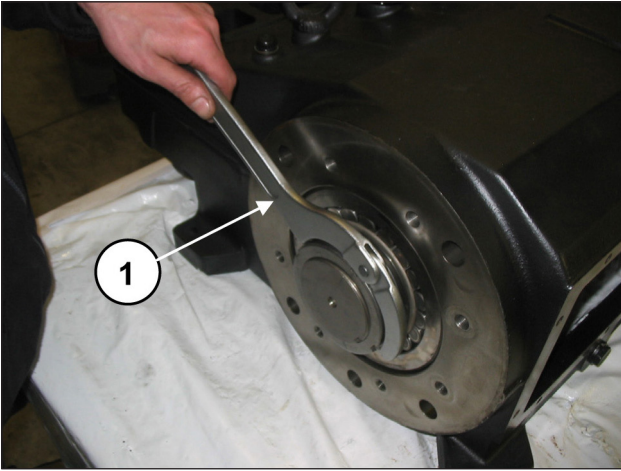

Fig. 17

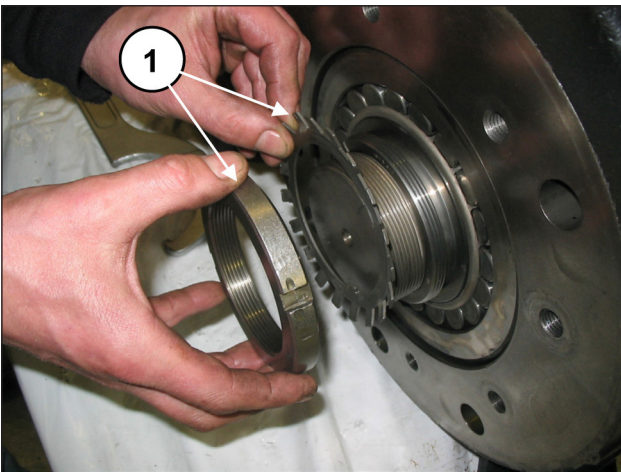

Fig. 18

Visser une bague type SKF KM19 sur la douille de pression (rep. ①, Fig. 19) puis utiliser une clé appropriée pour desserrer la douille (rep. ①, Fig. 20).

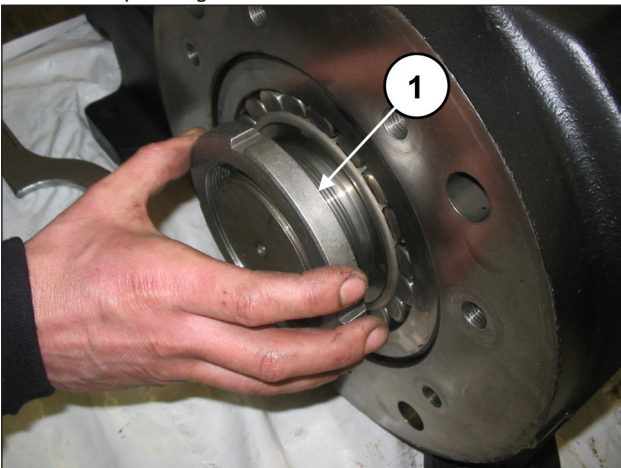

Fig. 19

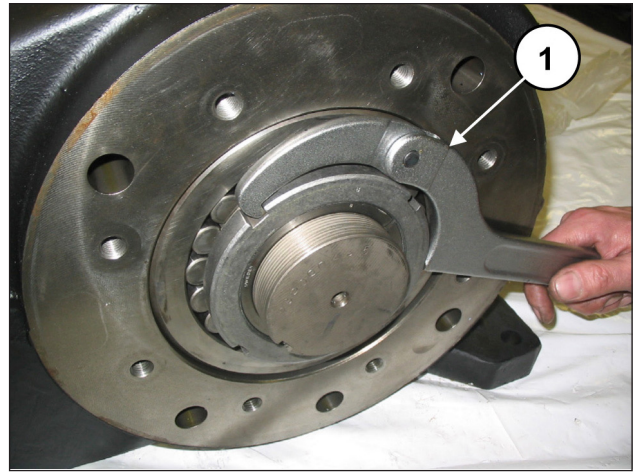

Fig. 20

De l'autre côté, dévisser les vis de fixation du boîtier du réducteur (rep. ①, Fig. 21) et le déposer (rep. ①, Fig. 22).

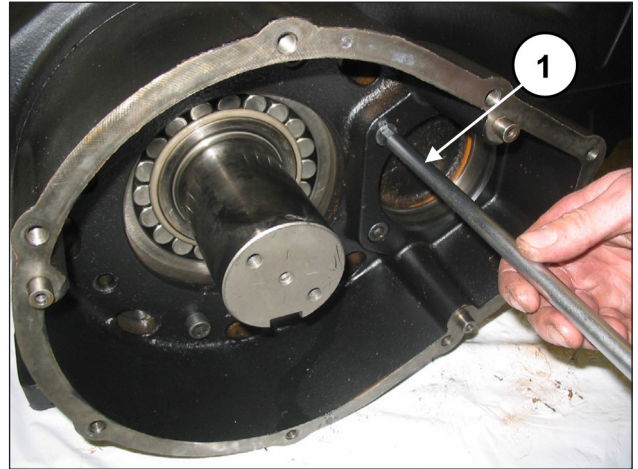

Fig. 21

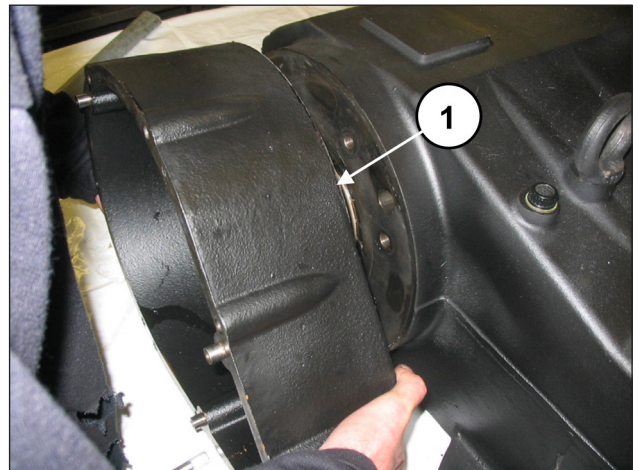

Fig. 22

Dévisser les vis de la bielle (rep. ①, Fig. 23).

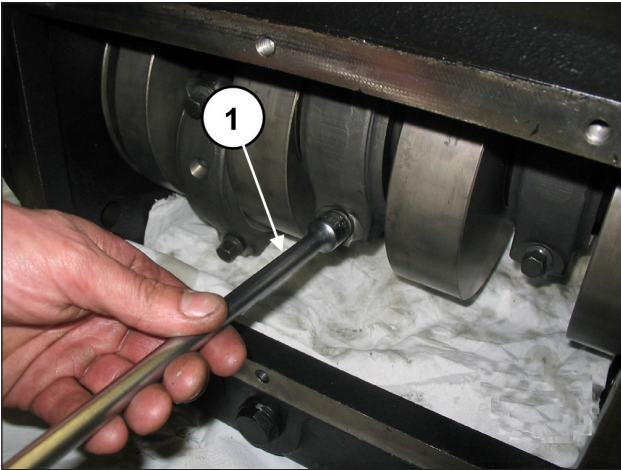

Fig. 23

Démonter les chapeaux de bielle avec les demi-coussinets en prenant note de l'ordre de démontage.



Remonter et accoupler les chapeaux de bielle et leurs demi-bielles dans l'ordre selon lequel ils ont été démontés.

Pour éviter toute erreur possible, les chapeaux et les demi-bielles ont été numérotés sur un côté (rep. ①, Fig. 24).

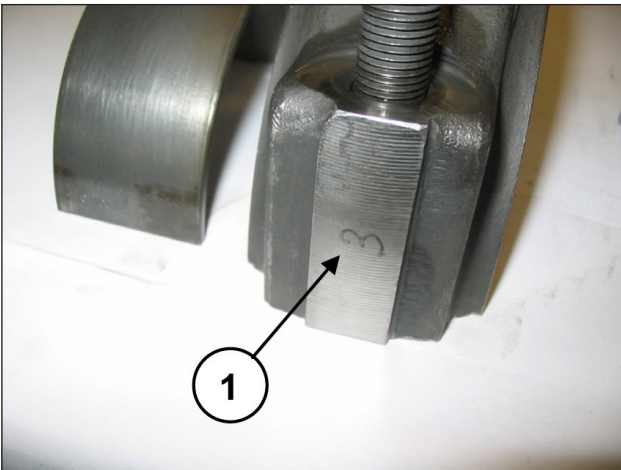

Fig. 24

Pousser à fond les demi-bielles dans la direction de la partie hydraulique pour faire ressortir le vilebrequin. Pour faciliter l'opération, utiliser l'outil (réf. 27566200 (rep. ①, Fig. 25).

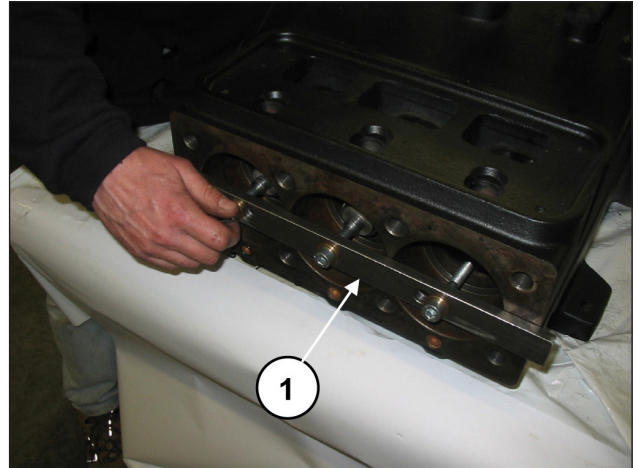

Fig. 25

Déposer la douille de pression (rep. ①, Fig. 26).

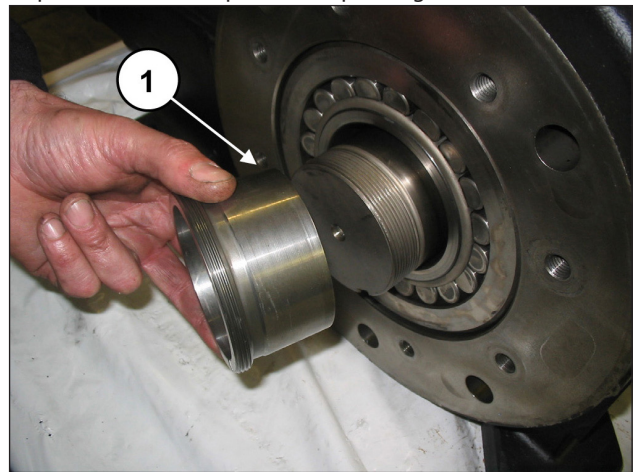

Fig. 26

Dégager les trois demi-coussinets supérieurs des demi-bielles (rep. ①, Fig. 27).

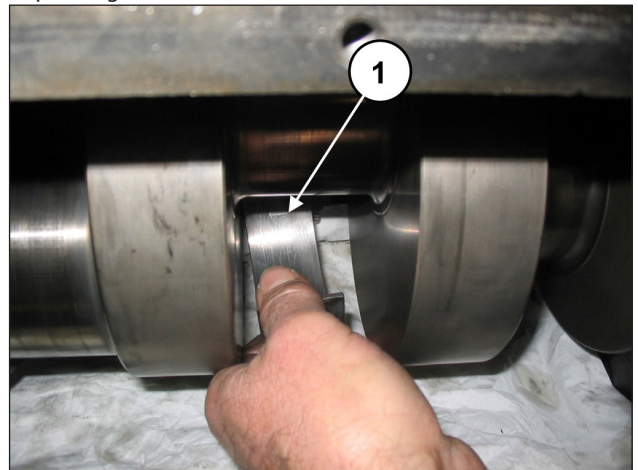

Fig. 27

Dégager le vilebrequin à l'aide d'un outil à inertie, côté PTO (rep. ①, Fig. 28).

Dégager l'arbre et le coussinet (rep. ①, Fig. 29).

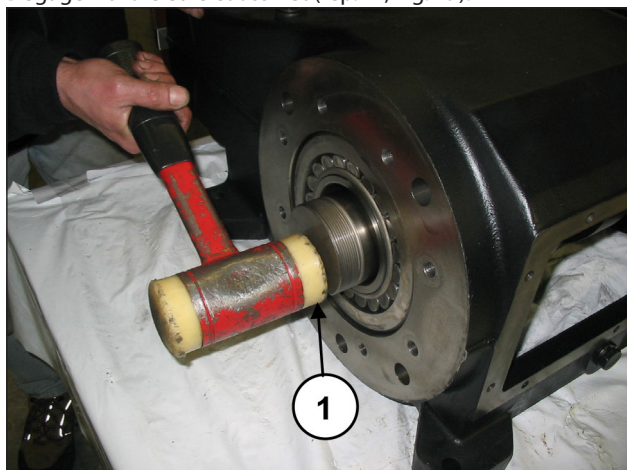

Fig. 28

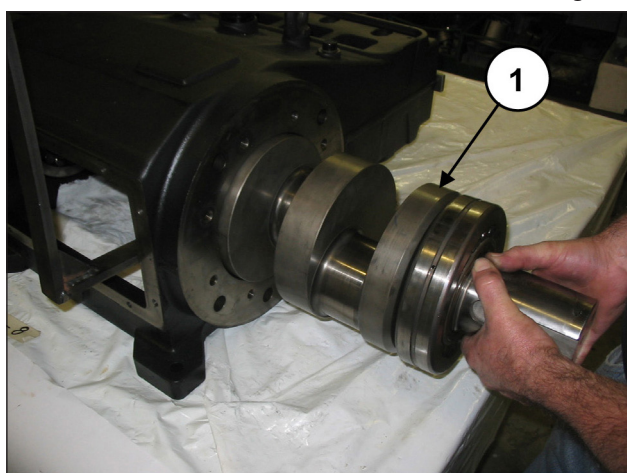

Fig. 29

De l'autre côté, extraire le coussinet (rep. ①, Fig. 30).



Fig. 30

S'il s'avère nécessaire de remplacer une ou plusieurs bielles ou guides de piston, procéder de la façon suivante :

Dévisser les vis de l'outil réf. 27566200 pour débloquer les bielles (rep. ①, Fig. 31) puis dégager les ensembles bielle-guide de piston par l'ouverture arrière du carter (rep. ①, Fig. 32).

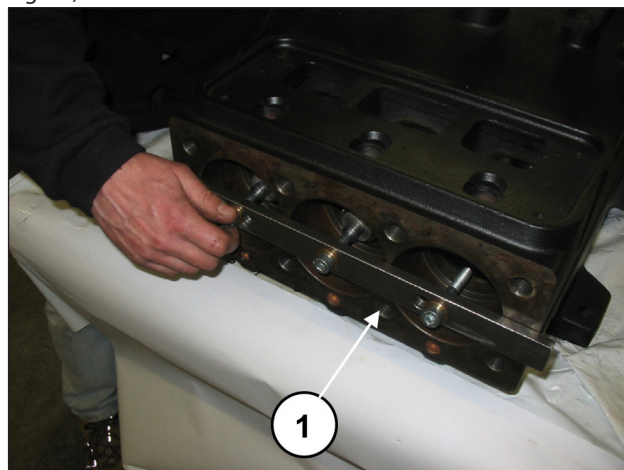

Fig. 31

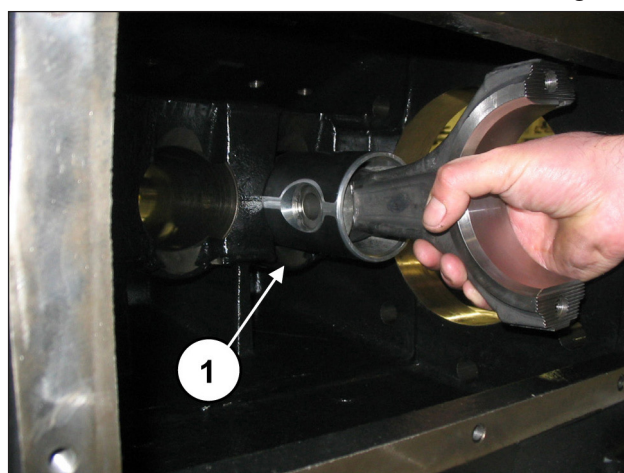

Fig. 32

Accoupler les demi-bielles avec les chapeaux préalablement démontés en suivant la numérotation (rep. ①, Fig. 33).

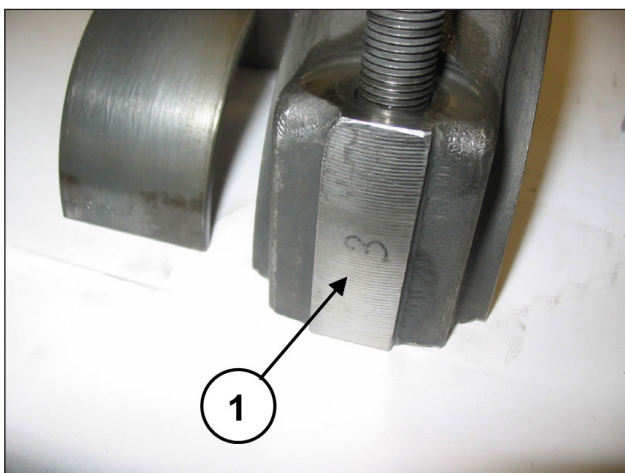

Fig. 33

Déposer les deux anneaux Seeger de retenue de la goupille à l'aide d'un outil approprié (rep. ①, Fig. 34).

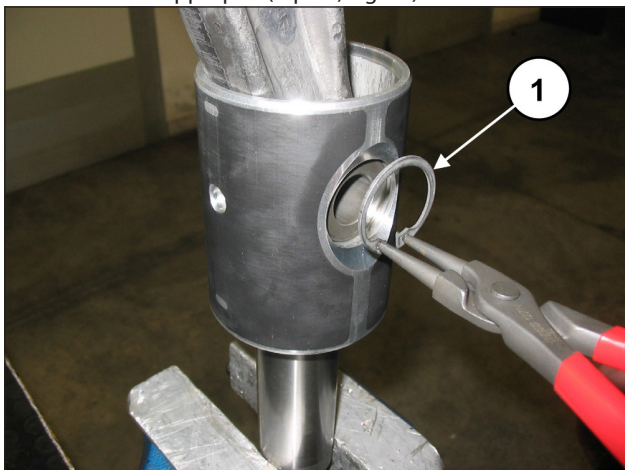

Fig. 34

Dégager la goupille (rep. ①, Fig. 35) et extraire la bielle (rep. ①, Fig. 36).



Fig. 35

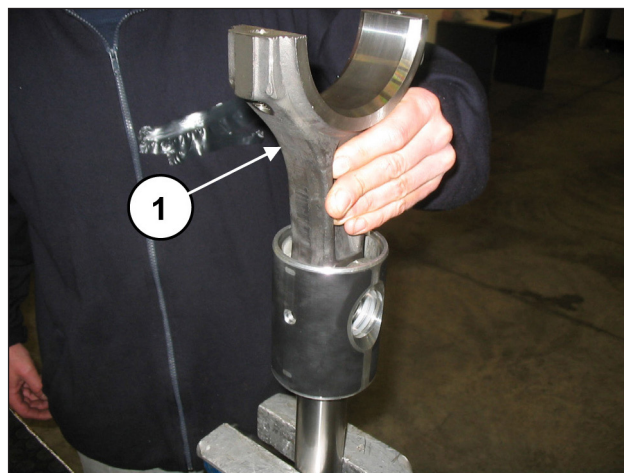

Fig. 36

Pour désassembler la tige du guide de piston, dévisser les vis à tête cylindrique M6 à l'aide d'une clé spéciale (rep. ①, Fig. 37).

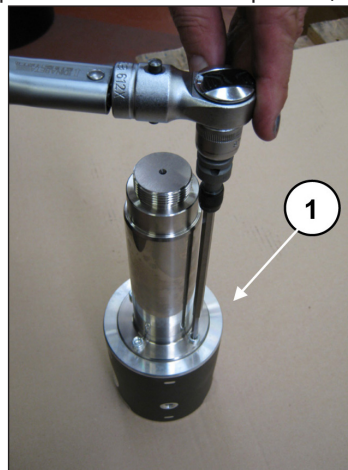

Fig. 37

2.1.2 Montage de la partie mécanique

Procéder au montage en inversant les opérations du parag. 2.1.1.

La séquence correcte est la suivante :

Assembler la tige au guide de piston.

Insérer la tige du guide de piston dans le logement prévu à cet effet sur le guide de piston (rep. ①, Fig. 38) et le fixer sur ce dernier à l'aide des 4 vis à tête cylindrique M6x20 (rep. ①, Fig. 39).



Fig. 38



Fig. 39

Bloquer le guide de piston dans un étau à l'aide d'un outil spécial et serrer les vis à l'aide d'une clé dynamométrique (rep. ①, Fig. 40) selon les explications figurant au chapitre 3.

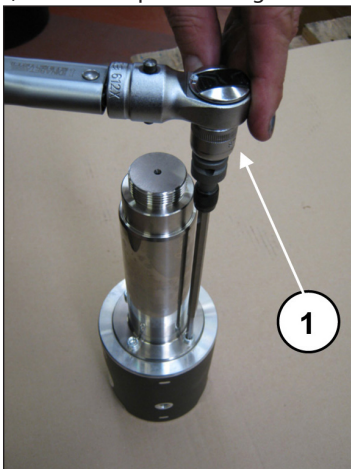

Fig. 40

Insérer la bielle dans le guide de piston (rep. ①, Fig. 36) puis insérer la goupille (rep. ①, Fig. 35). Appliquer les deux Seeger d'appui à l'aide de l'outil approprié (rep. ①, Fig. 34).



Le montage est correct lorsque le pied de bielle, le guide de piston et la goupille tournent sans problèmes.

Désassembler les chapeaux des demi-bielles ; pour les accoupler correctement, suivre la numérotation présente sur un côté (rep. ①, Fig. 33).

Après s'être assuré que le carter est propre, insérer l'ensemble demi-bielle/guide de piston dans les tiges du carter (rep. ①, Fig. 32).



Insérer l'ensemble demi-bielle/guide de piston dans le carter en tournant les demi-bielles de sorte que la numérotation soit visible sur le dessus.

Bloquer les trois groupes à l'aide de l'outil réf. 27566200 (rep. ①, Fig. 31).

Prémontier le coussinet côté PTO sur l'arbre et le pousser à fond (rep. ①, Fig. 41) puis monter le coussinet de l'autre côté sur le carter (rep. ①, Fig. 42).



La bague interne du coussinet Fig. 42 est conique. Vérifier que la conicité va de l'extérieur vers l'intérieur pour recevoir correctement la douille.

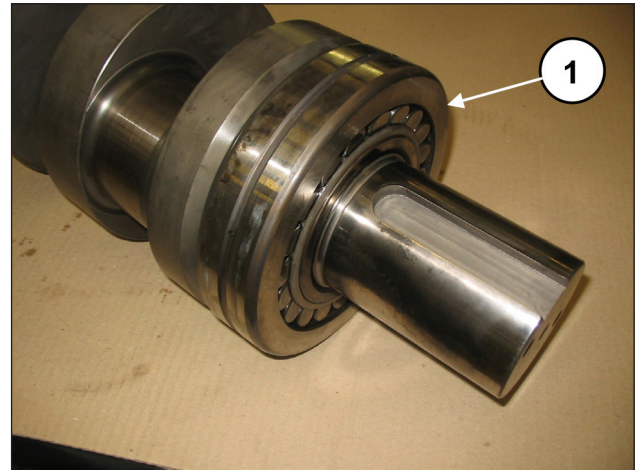

Fig. 41

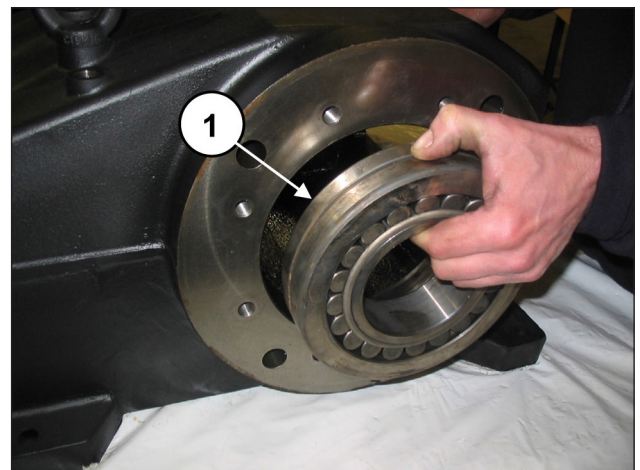

Fig. 42

Insérer l'arbre (rep. ①, Fig. 29) jusqu'à ce que le coussinet prémonté arrive au ras du bord du carter (rep. ①, Fig. 43).

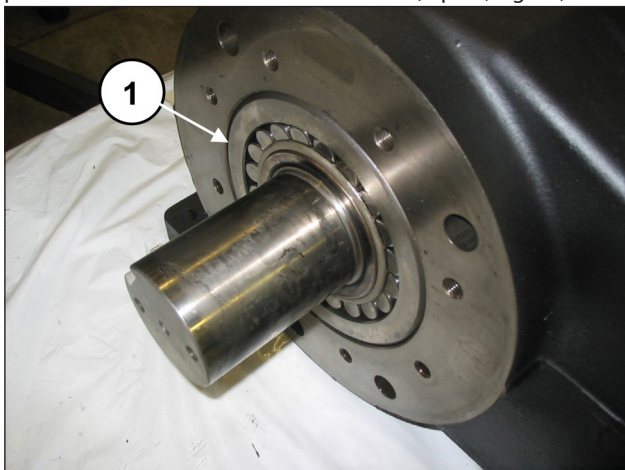

Fig. 43

Insérer manuellement la douille de pression pour assurer l'alignement de l'arbre (rep. ①, Fig. 44).

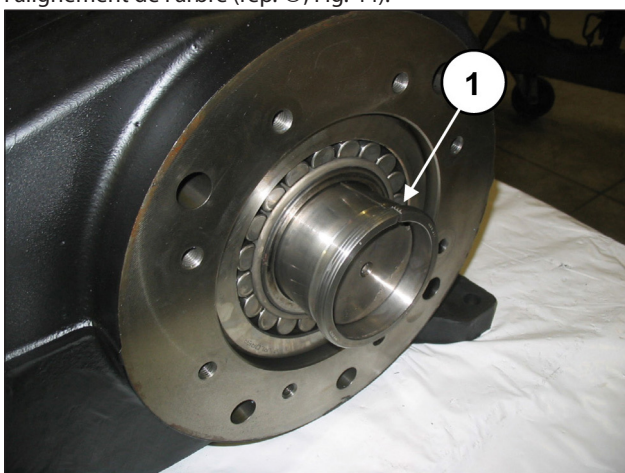

Fig. 44

Monter le boîtier du réducteur (rep. ①, Fig. 45) avec son joint (rep. ②, Fig. 45) en utilisant les 6 vis M12x40 (rep. ①, Fig. 46), les 2 vis M12x50 (rep. ①, Fig. 47) et les rondelles Grower Ø12 (rep. ②, Fig. 46 et Fig. 47).

Serrer les vis à l'aide de la clé dynamométrique (rep. ①, Fig. 48) selon les explications figurant au chapitre 3.

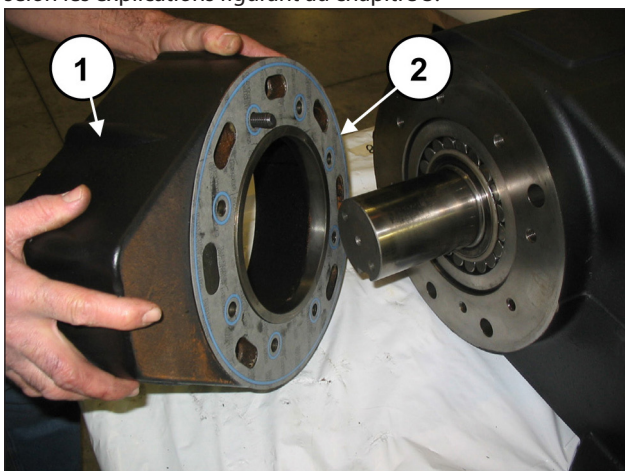

Fig. 45

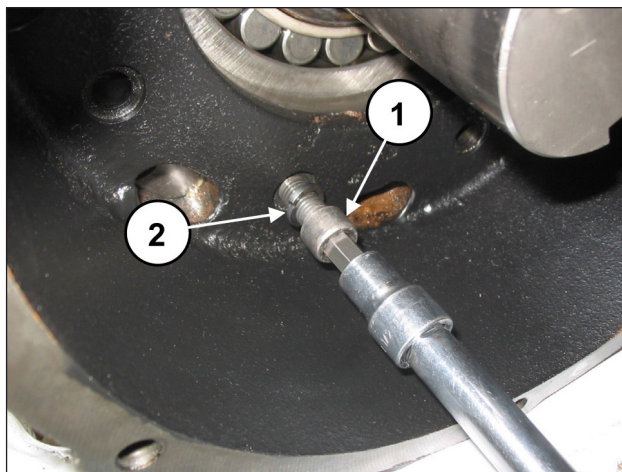

Fig. 46

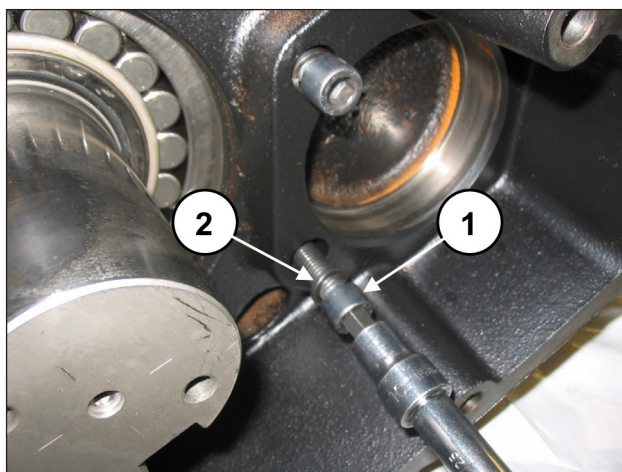

Fig. 47

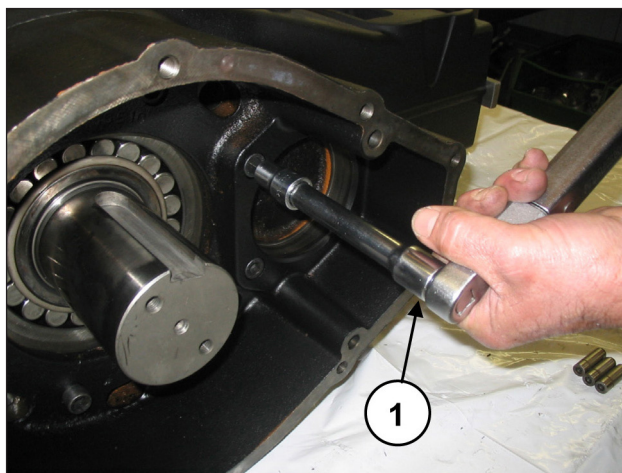

Fig. 48

Pousser à fond la douille de pression sur l'arbre, du côté opposé à la PTO (rep. ①, Fig. 49 et Fig. 50).

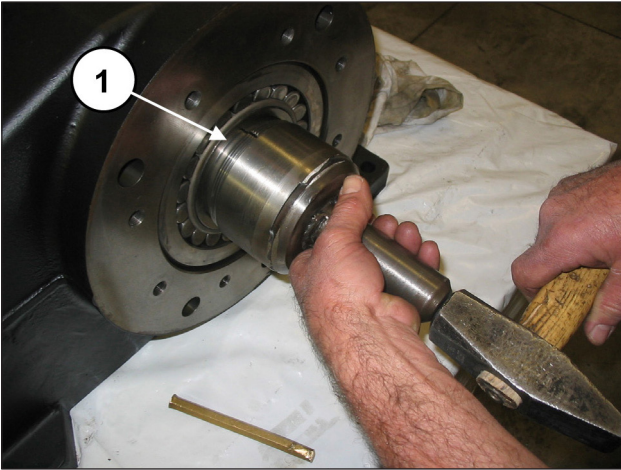

Fig. 49

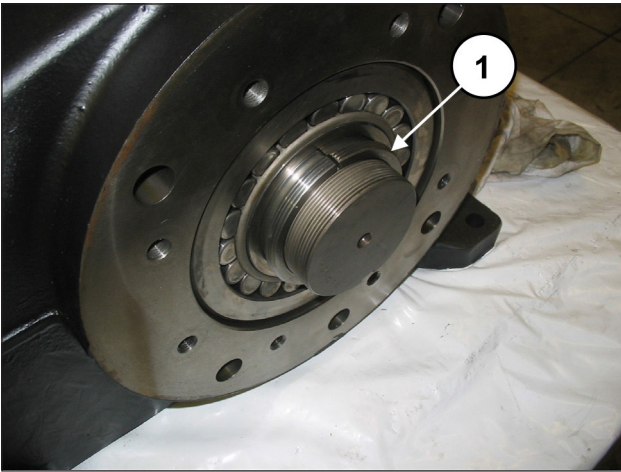

Fig. 50



Installer la douille de pression à sec (sans huile ni lubrifiant).

Insérer la douille jusqu'à ce que la piste extérieure (conique) s'accouple parfaitement avec la piste intérieure du coussinet. Durant la pose, s'assurer que le coussinet reste en contact avec la bague d'appui de l'arbre.

Mesurer la cote « X » indiquée Fig. 51.

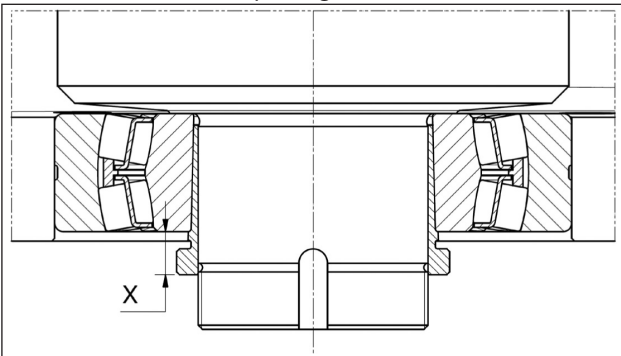

Fig. 51

Visser la bague de blocage et serrer la douille de sorte à déterminer une réduction de la cote « X » comprise entre 0,7 et 0,8 mm (Fig. 52).

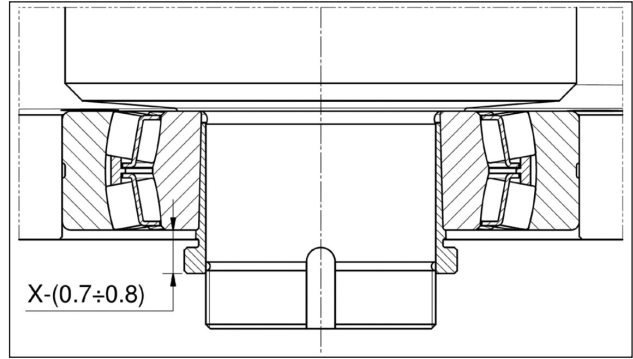

Fig. 52

Dévisser la bague et insérer la rondelle de sécurité (rep. ①, Fig. 53) puis revisser à fond la bague (rep. ①, Fig. 54), après quoi, plier la languette de retenue de la rondelle (rep. ①, Fig. 55).

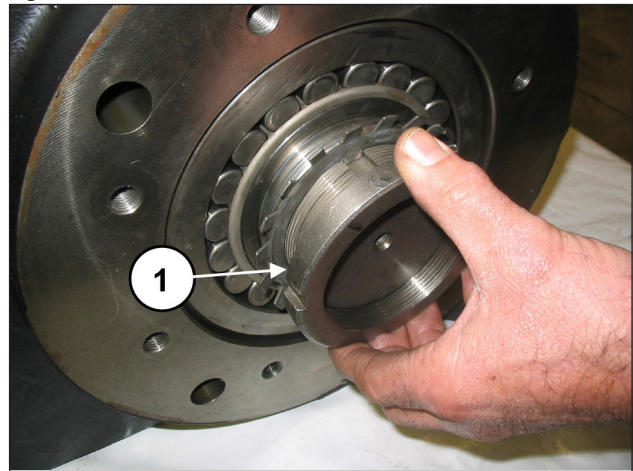

Fig. 53

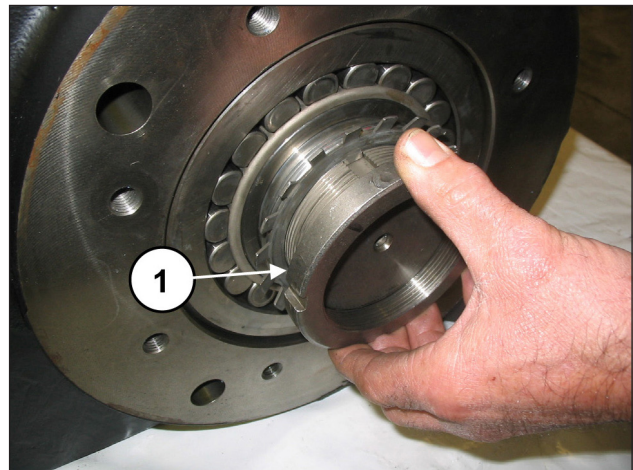

Fig. 54

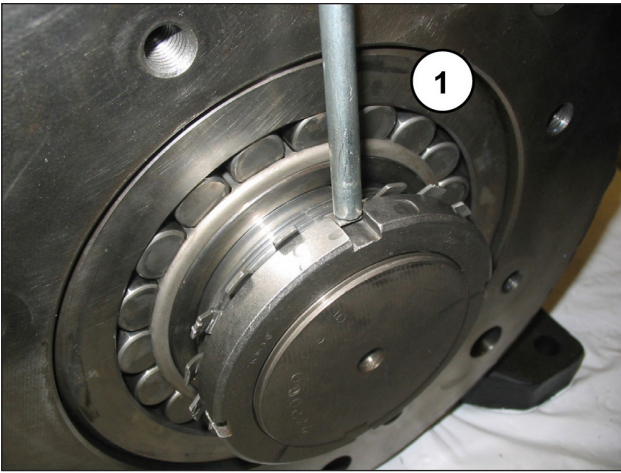

Fig. 55

Déposer l'outil de blocage des bielles réf. 27566200 (rep. ①, Fig. 31).

Insérer les demi-coussinets supérieurs entre les bielles et l'arbre (rep. ①, Fig. 56).



Pour monter correctement les demi-coussinets, s'assurer que la languette de repère des demi-coussinets se trouve dans son logement sur la demi-bielle (rep. ①, Fig. 57).

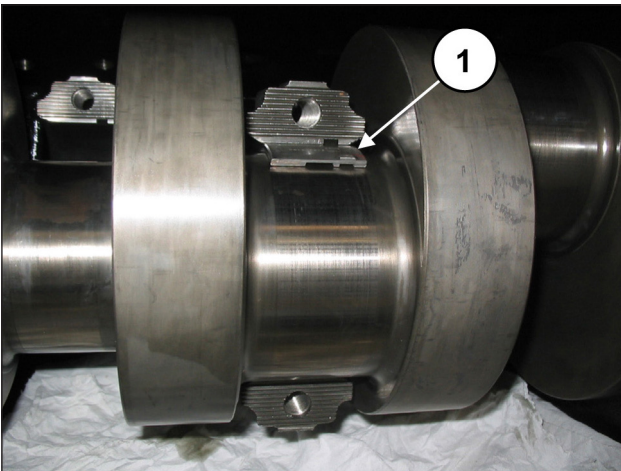

Fig. 56

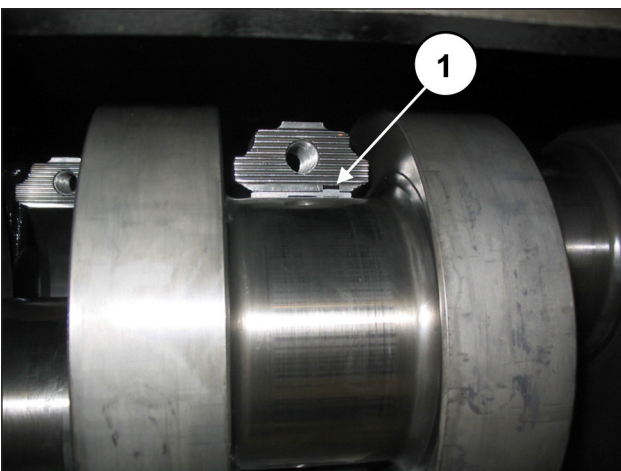

Fig. 57

Assembler les demi-coussinets inférieurs aux chapeaux (rep. ①, Fig. 58) en s'assurant que la languette de repère des demi-coussinets se trouve dans son logement sur le chapeau (rep. ②, Fig. 58).

Fixer les chapeaux sur les demi-bielles à l'aide des vis M12x1,25x87 (rep. ①, Fig. 59).



Faire attention au sens de montage des chapeaux. La numérotation doit être tournée vers le haut.

Serrer les vis à l'aide d'une clé dynamométrique, en suivant les explications du chapitre 3 ; serrer les vis au couple préconisé simultanément.

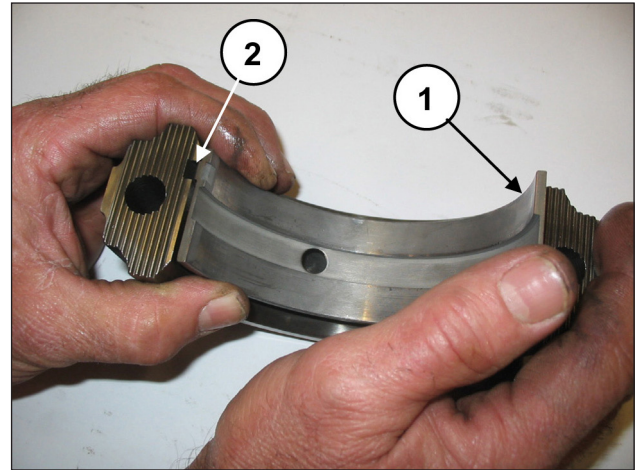

Fig. 58

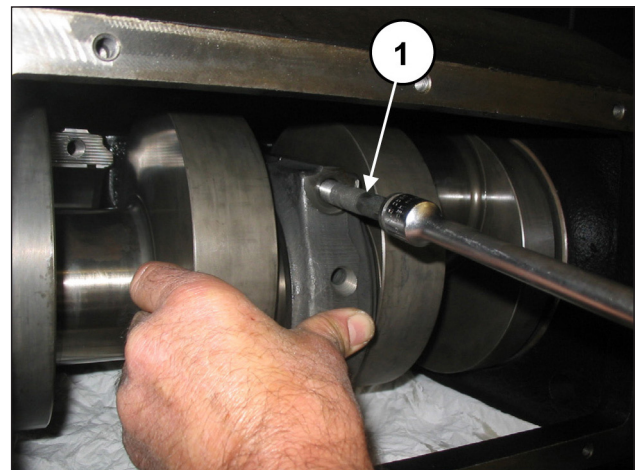

Fig. 59



Une fois l'opération terminée, s'assurer que les bielles présentent un jeu axial dans les deux directions.

Prémonter le coussinet sur le pignon (rep. ①, Fig. 60) et pousser à fond le pignon dans le logement sur le boîtier du réducteur (rep. ①, Fig. 61) à l'aide d'un outil à inertie.

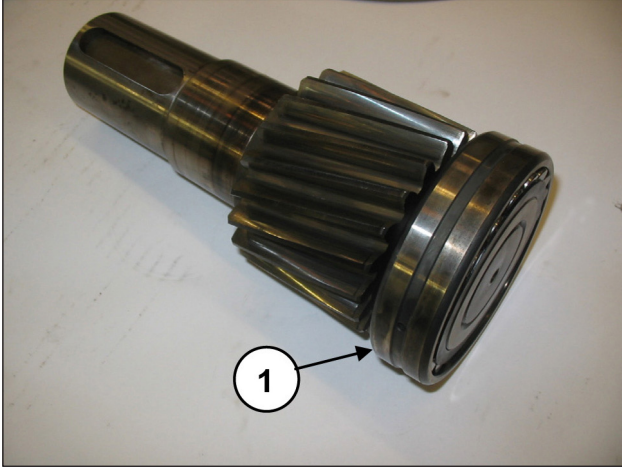

Fig. 60

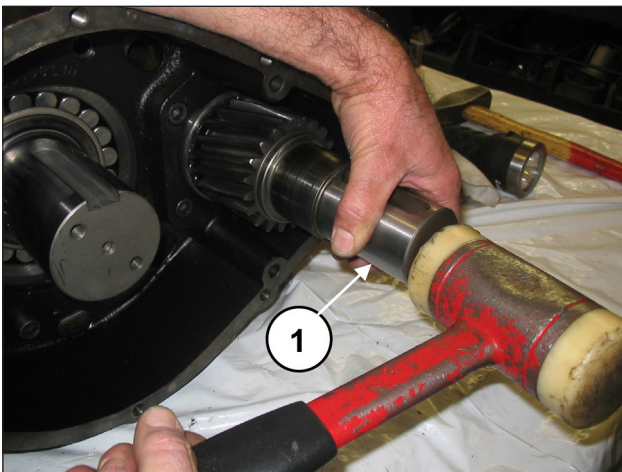

Fig. 61

Appliquer la languette 22x14x100 dans le logement de l'arbre (rep. ①, Fig. 62) et insérer la couronne sur l'arbre. Fixer le dispositif d'arrêt de la couronne (rep. ①, Fig. 63) en utilisant les 2 vis M10x25 (rep. ②, Fig. 63). Serrer les vis à l'aide d'une clé dynamométrique, en suivant les explications du chapitre 3.

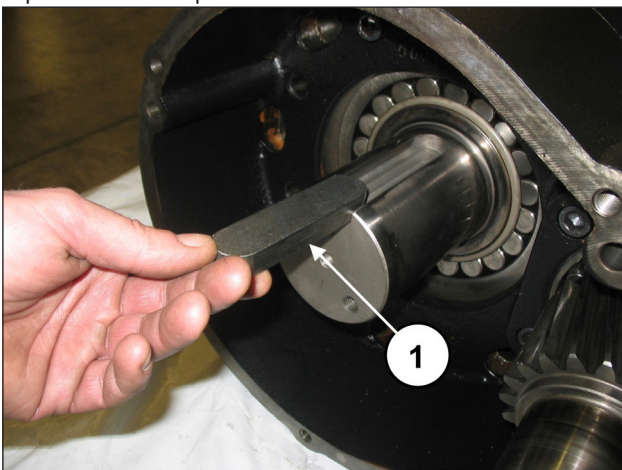

Fig. 62

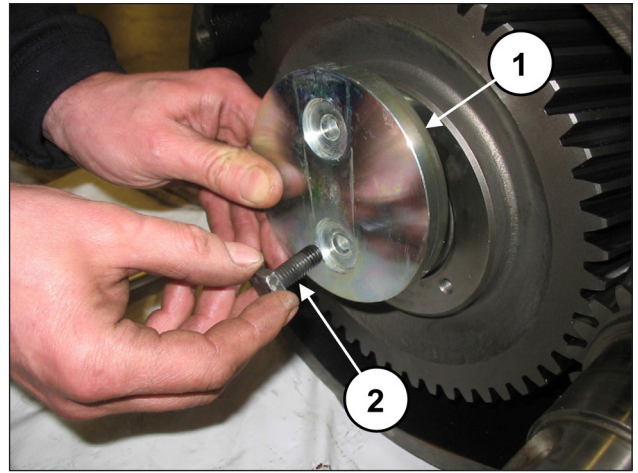

Fig. 63

Appliquer les 3 goupilles Ø12x40 au boîtier du réducteur (rep. ①, Fig. 64) et insérer le joint (rep. ①, Fig. 65).

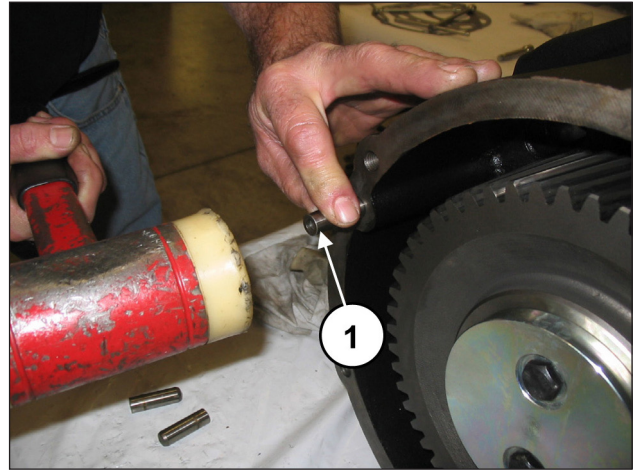

Fig. 64

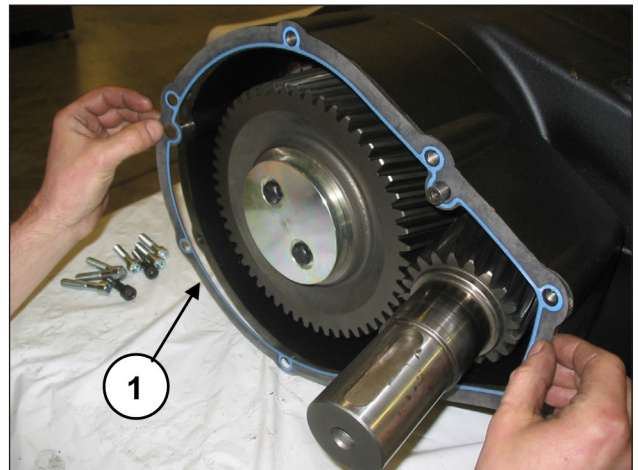

Fig. 65

Monter le coussinet sur le couvercle du réducteur (rep. ①, Fig. 66).

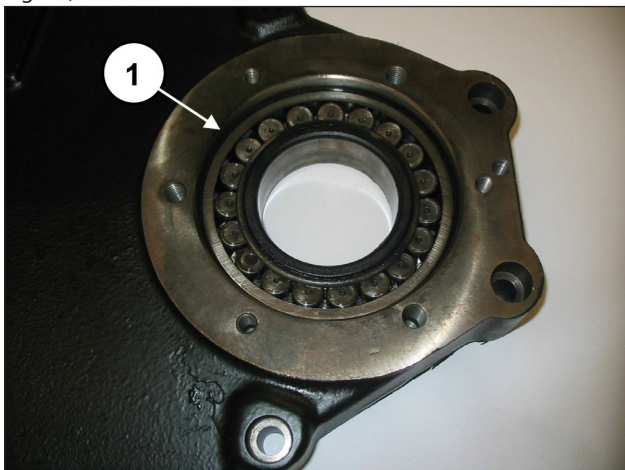

Fig. 66

Monter le couvercle du réducteur (rep. ①, Fig. 67) et le fixer à l'aide de 8 vis M10x50 (rep. ①, Fig. 68). Utiliser un tampon pour éviter que le coussinet ne sorte de son siège (rep. ①, Fig. 69). Serrer les vis à l'aide d'une clé dynamométrique, en suivant les explications du chapitre 3.

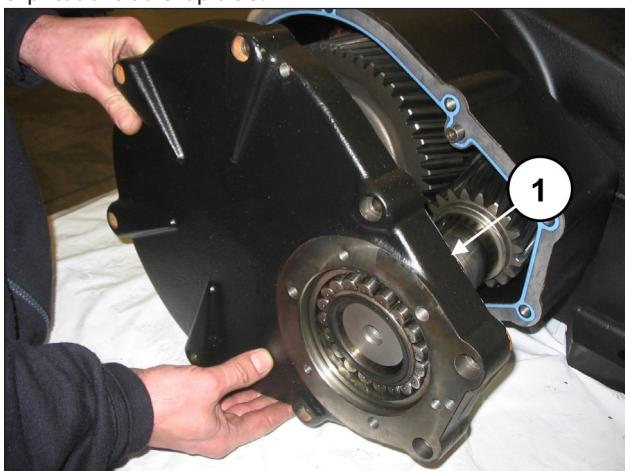

Fig. 67

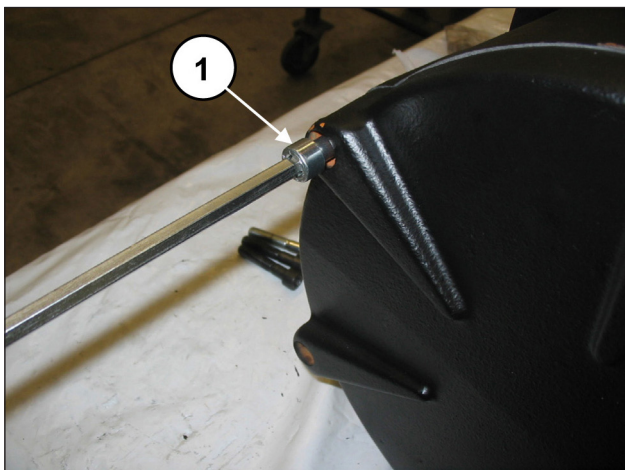

Fig. 68



Fig. 69

Insérer le joint d'huile dans le flasque du réducteur à l'aide des outils réf. 27515900 et 27548200 (rep. ①, Fig. 70).

Avant de procéder au montage du joint d'huile, vérifier les conditions de la lèvre d'étanchéité. S'il s'avère nécessaire de remplacer le joint, placer le nouveau joint sur le fond de la gorge comme le montre la Fig. 71



Si l'arbre présente une usure diamétrale correspondant à la lèvre d'étanchéité, pour éviter la rectification, placer le joint en deuxième position, comme le montre la Fig. 71.

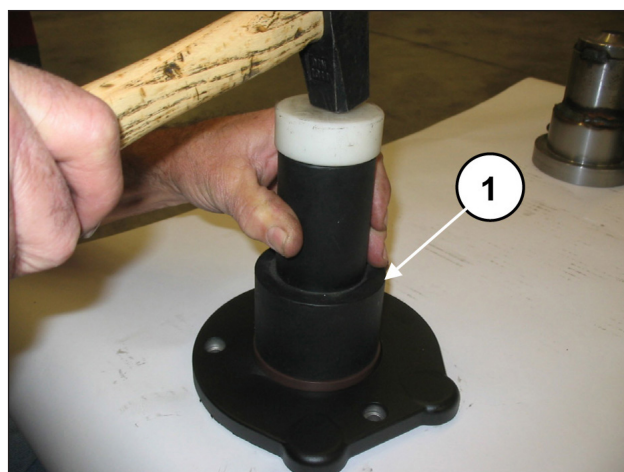

Fig. 70

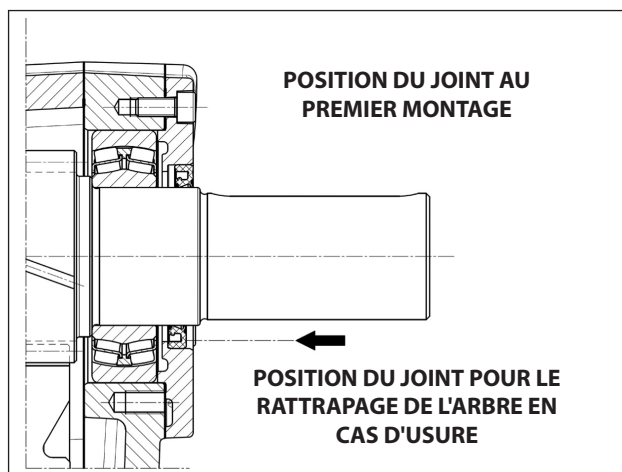

Fig. 71

Appliquer le flasque du réducteur avec son joint sur le boîtier du réducteur (rep. ①, Fig. 72) et le visser à l'aide de 3 vis M8x18 (rep. ①, Fig. 73).



Pour éviter d'endommager le joint d'huile, introduire délicatement le flasque sur le pignon.

Serrer les vis à l'aide d'une clé dynamométrique, en suivant les explications du chapitre 3.

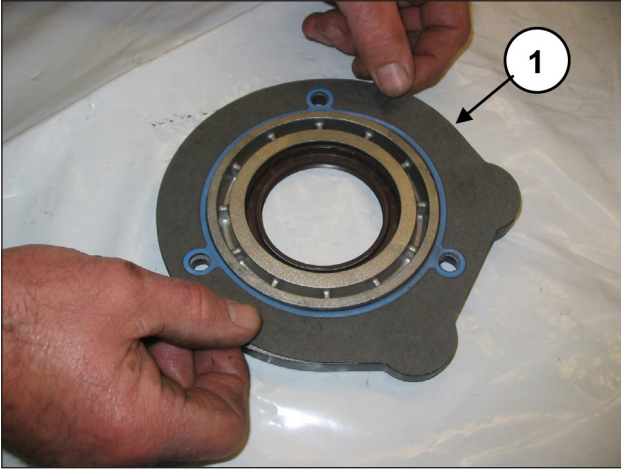

Fig. 72

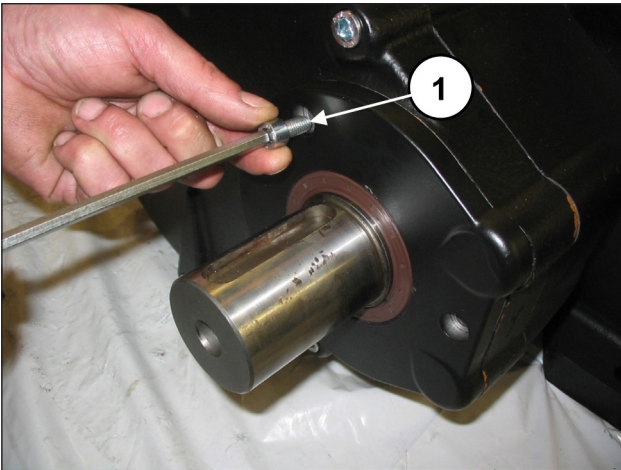

Fig. 73

Insérer la languette 16x10x90 dans le pignon.
Insérer le joint torique dans le couvercle arrière (rep. ①, Fig. 74) et le fixer au carter à l'aide de 10 vis M8x18 (rep. ①, Fig. 75).
Serrer les vis à l'aide d'une clé dynamométrique, en suivant les explications du chapitre 3.

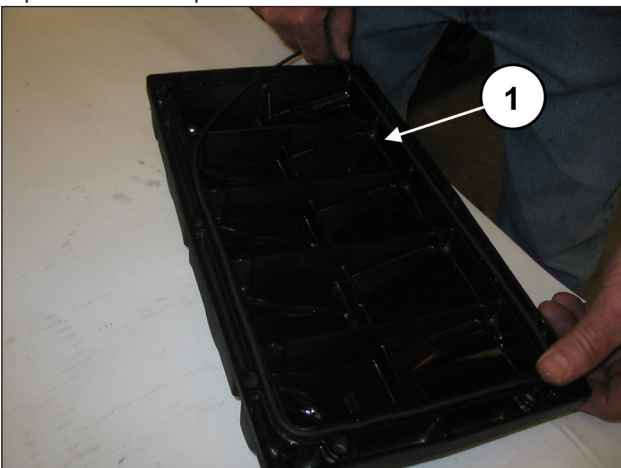

Fig. 74

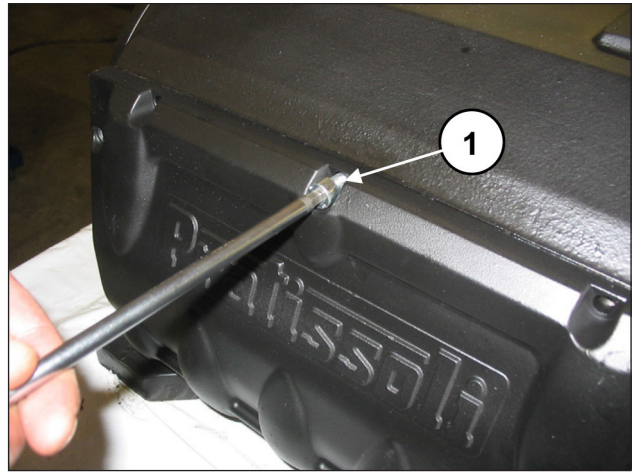

Fig. 75

Monter le couvercle du coussinet (et son joint) (rep. ①, Fig. 76) à l'aide de 8 vis M12x30 (rep. ①, Fig. 77).

Serrer les vis à l'aide d'une clé dynamométrique, en suivant les explications du chapitre 3.

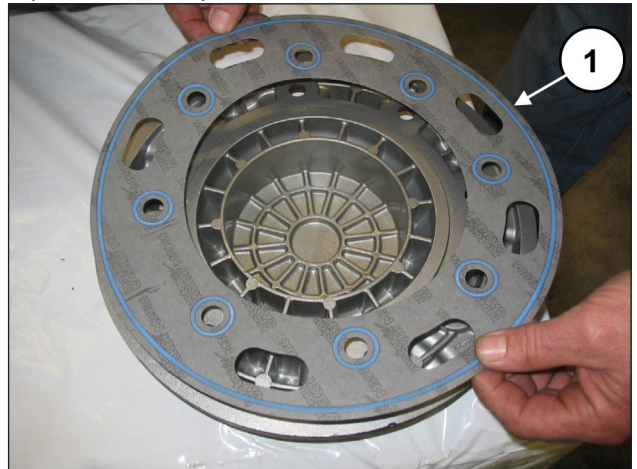

Fig. 76

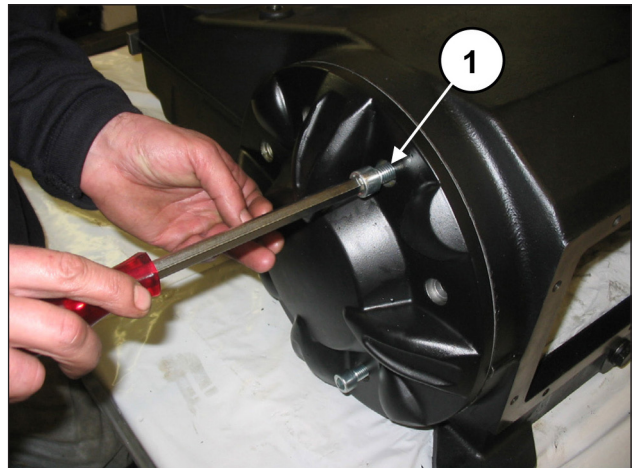

Fig. 77

Compléter le montage de la partie mécanique en appliquant les bouchons et les œillets de levage avec leur joint torique d'étanchéité.

Verser l'huile dans le carter en suivant les explications dans le **Manuel d'utilisation et d'entretien**, parag. 7.4.

2.1.3 Classes de majorations prévues

TABLEAU DE MAJORATIONS POUR VILEBREQUIN ET DEMI-COUSSINETS DE BIELLE			
Classes de rattrapage (mm)	Code Demi-coussinet Supérieur	Code Demi-coussinet Inférieur	Rectification sur le diamètre du goujon de l'arbre (mm)
0.25	90931100	90930100	Ø92.75 0/-0.03 Ra 0.4 Rt 3.5
0.50	90931200	90930200	Ø92.50 0/-0.03 Ra 0.4 Rt 3.5

TABLEAU DES MAJORATIONS POUR CARTER DE POMPE ET GUIDE DE PISTON		
Classes de rattrapage (mm)	Référence Guide de piston	Rectification sur le siège du carter de pompe (mm)
1.00	79050543	Ø81 H6 +0.022/0 Ra 0.8 Rt 6

2.2 RÉPARATION DE LA PARTIE HYDRAULIQUE

2.2.1 Désassemblage de la tête - groupes des soupapes

La tête nécessite un entretien préventif, selon les indications du *Manuel d'utilisation et d'entretien*.

Les interventions se limitent à l'inspection ou au remplacement des soupapes, en cas de besoin.

Pour l'extraction des groupes de la soupape, procéder de la façon suivante :

Dévisser les 8 vis M16x55 du couvercle des soupapes (rep. ①, Fig. 78) et déposer le couvercle (rep. ①, Fig. 79).

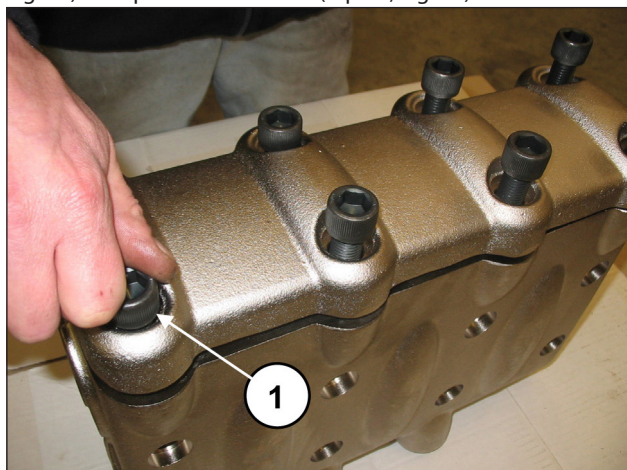

Fig. 78

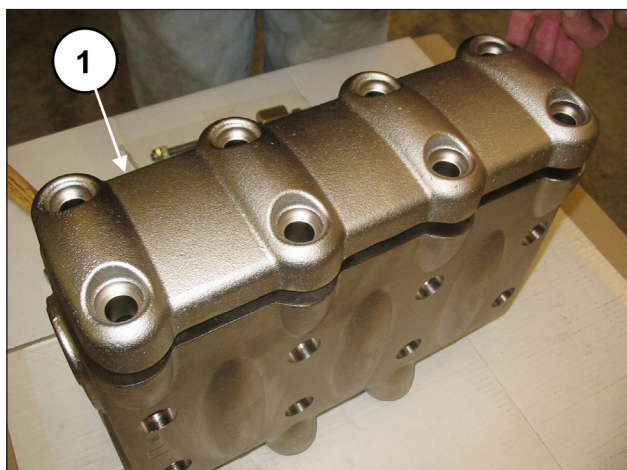

Fig. 79

Extraire le bouchon de soupape en appliquant un chasoir à inertie sur l'orifice M10 du bouchon (rep. ①, Fig. 80).

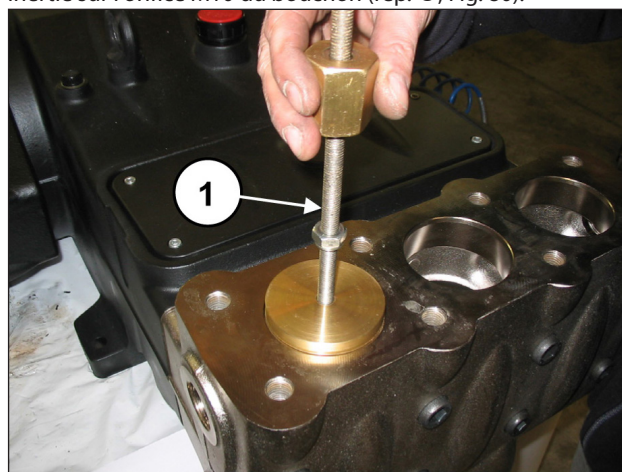

Fig. 80

Dégager le ressort (rep. ①, Fig. 81).

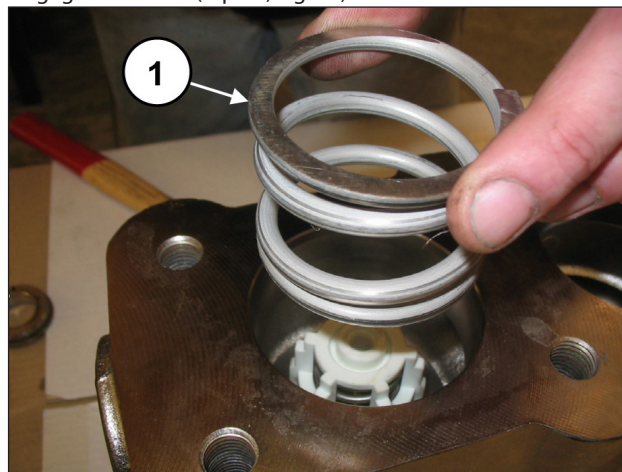

Fig. 81

Extraire le groupe soupape de refoulement en appliquant un chasoir à inertie sur l'orifice M10 du guide de soupape (rep. ①, Fig. 82).

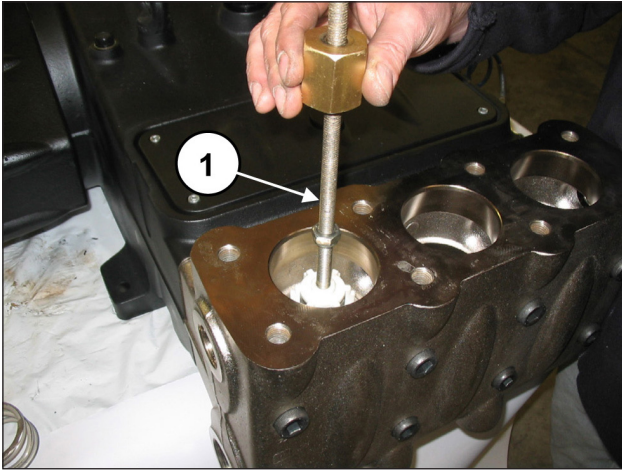

Fig. 82



S'il s'avère difficile d'extraire le groupe de la soupape de refoulement (par exemple, à cause de la présence d'incrustations dues à un arrêt prolongé de la pompe), utiliser l'extracteur réf. 27516400.

Extraire l'entretoise du guide de soupape à l'aide d'une clé hexagonale de 8 mm (rep. ①, Fig. 83).

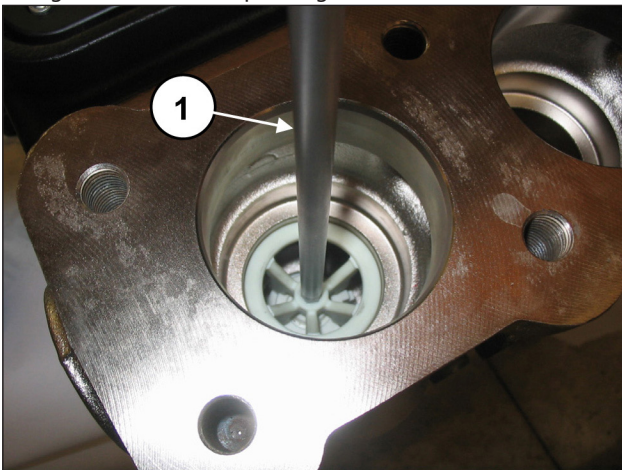

Fig. 83

Extraire le groupe soupape d'aspiration en appliquant un chasoir à inertie sur l'orifice M10 du guide de soupape (rep. ①, Fig. 84).

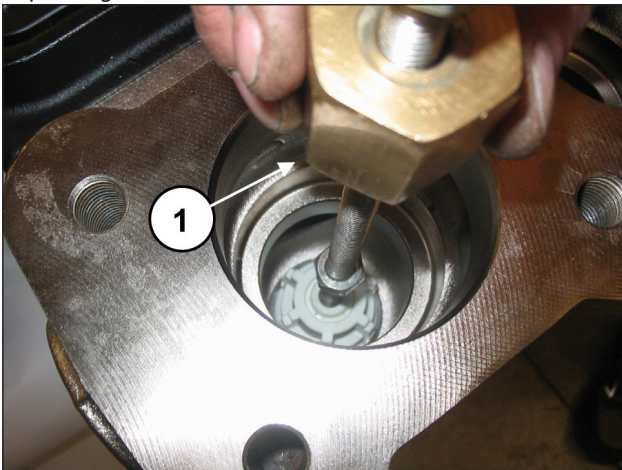

Fig. 84



S'il s'avère difficile d'extraire le groupe de la soupape d'aspiration (par exemple, à cause de la présence d'incrustations dues à un arrêt prolongé de la pompe), utiliser l'extracteur réf. 27516200 (pour les versions avec Ø Piston : 40 - 45 - 50) ou réf. 27516300 (pour les versions avec Ø Piston : 55 - 60 - 65).

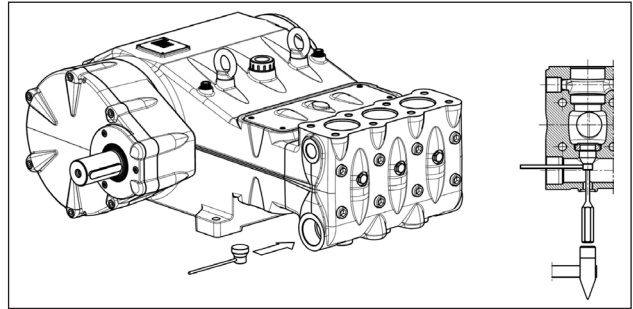

Fig. 85

Desserrer le dispositif d'ouverture des soupapes à l'aide d'une clé de 30 mm (rep. ①, Fig. 86).

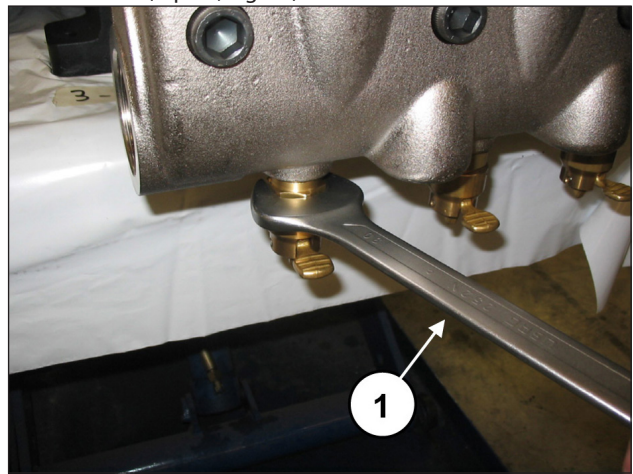

Fig. 86

Démonter les groupes de la soupape d'aspiration et de refoulement en vissant une vis M10 de sorte à appuyer sur le guide interne pour l'extraire du siège de la soupape (rep. ①, Fig. 87).

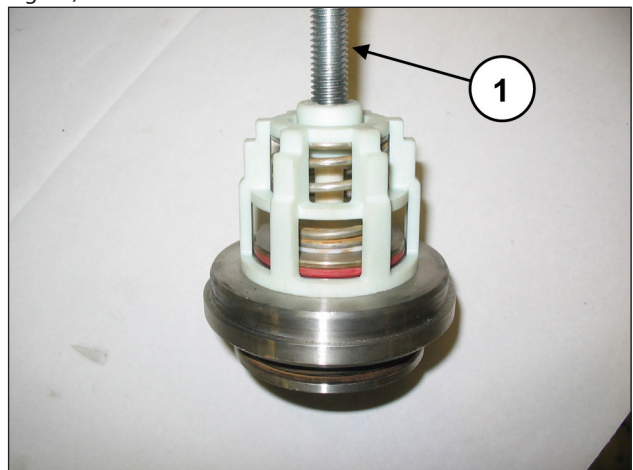

Fig. 87

2.2.2 Remontage de la tête - ensembles de soupapes



Vérifier l'état d'usure des différents composants et les remplacer si nécessaire.
À chaque contrôle des soupapes, remplacer tous les joints toriques aussi bien des groupes que des bouchons de la soupape.



Avant de remplacer les groupes de la soupape, nettoyer et essuyer à fond les logements correspondants situés dans la tête et indiqués par les flèches (rep. ①, Fig. 88).

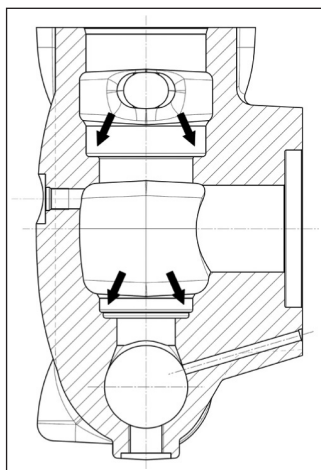

Fig. 88

Procéder au remontage en inversant les opérations de démontage du parag. 2.2.1.

Assembler les groupes de la soupape d'aspiration et de refoulement (Fig. 89 et Fig. 90) en ayant soin de ne pas inverser les ressorts préalablement démontés.

Pour monter plus facilement le guide de soupape dans le siège, il est possible d'utiliser un tuyau posé sur les plans horizontaux du guide (Fig. 91) et un outil à inertie pour agir sur toute la circonférence.



Fig. 89



Fig. 90

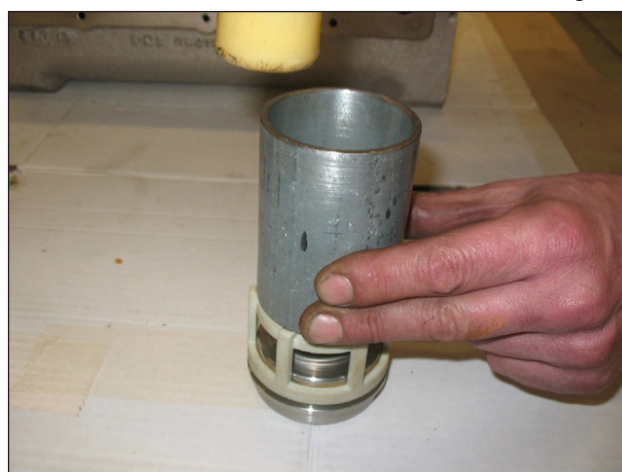

Fig. 91



Insérer les groupes de la soupape (aspiration et refoulement) dans la tête en respectant la séquence de pose des joints toriques et des bagues anti-extrusion.

La séquence correcte de montage des groupes soupape dans la tête est la suivante :

Insérer la bague anti-extrusion, rep. vue éclatée 4 (rep. ①, Fig. 92).

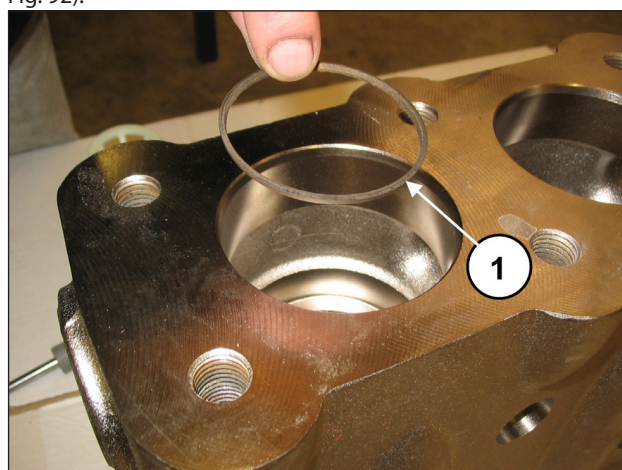

Fig. 92

Insérer le joint torique, rep. vue éclatée 5 (rep. ①, Fig. 93).

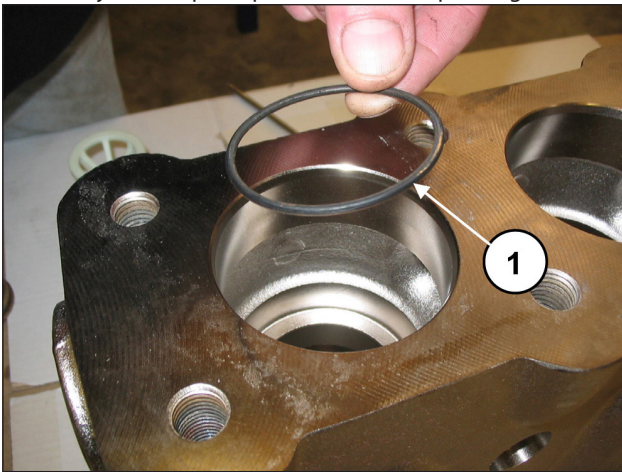

Fig. 93

S'assurer que le joint torique et la bague anti-extrusion sont entrés dans leur logement.

Insérer le groupe soupape d'aspiration (rep. ①, Fig. 94) puis l'entretoise (rep. ①, Fig. 95).

Pousser à fond le groupe soupape qui devra se présenter comme suit, rep. ①, Fig. 95.

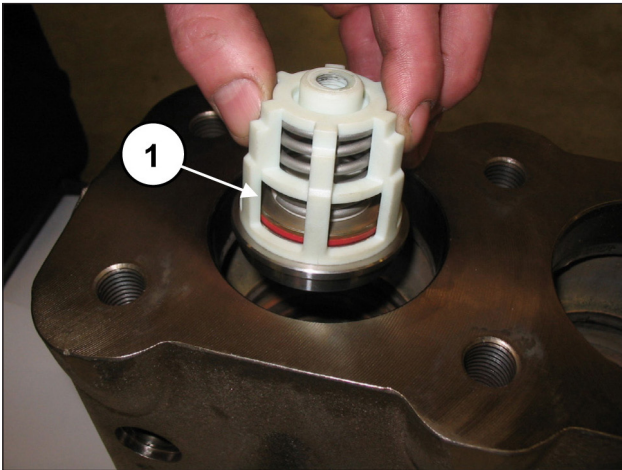

Fig. 94

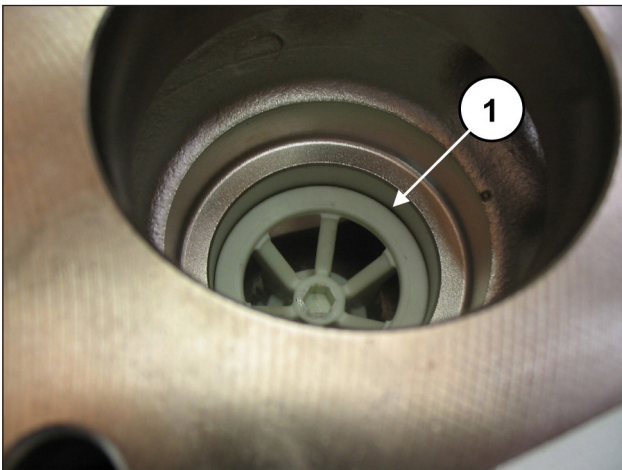

Fig. 95

Monter le joint torique, rep. vue éclatée 5 (rep. ①, Fig. 96) et la bague anti-extrusion, rep. vue éclatée 15 (rep. ②, Fig. 96) sur le siège de la soupape de refoulement.

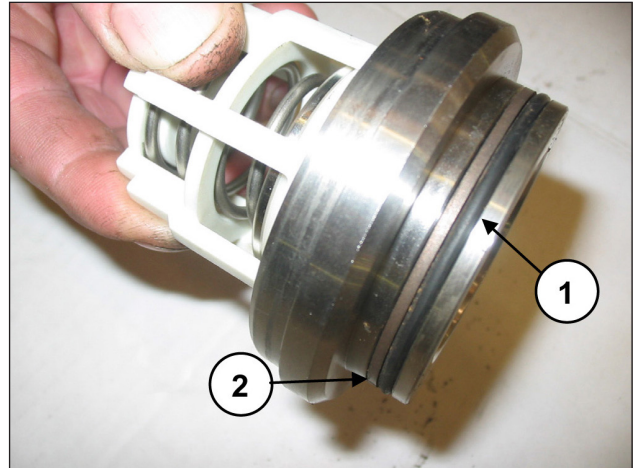

Fig. 96

Insérer le groupe soupape de refoulement (rep. ①, Fig. 97). Pousser à fond le groupe soupape qui devra se présenter comme suit, rep. ①, Fig. 98.

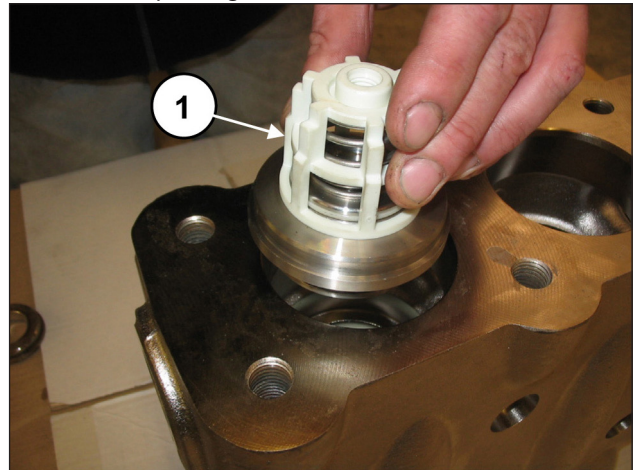

Fig. 97

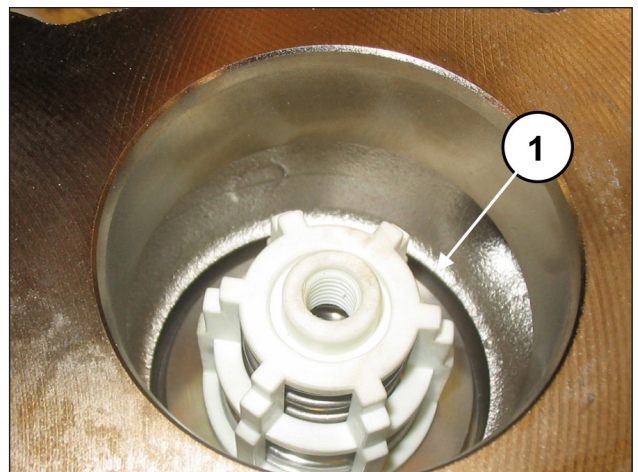

Fig. 98

Insérer la bague anti-extrusion, rep. vue éclatée 16 (rep. ①, Fig. 99).

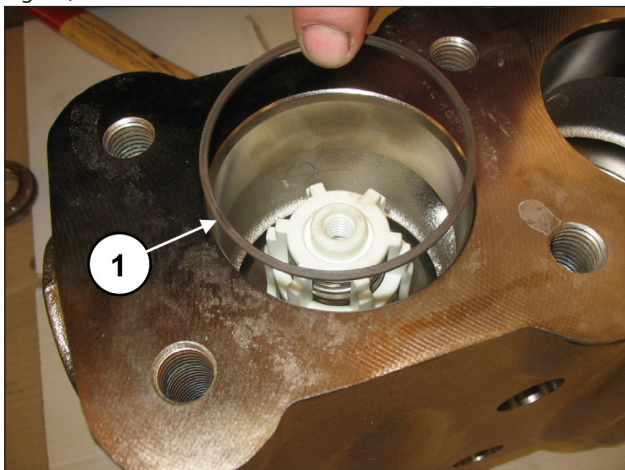

Fig. 99

Insérer le joint torique, rep. vue éclatée 17 (rep. ①, Fig. 100).

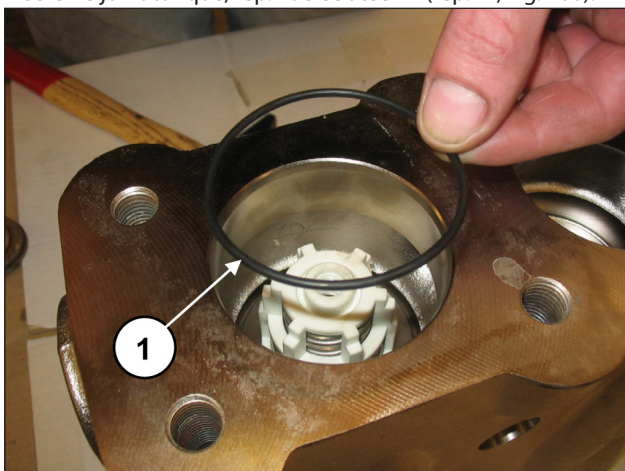

Fig. 100



Monter le joint torique rep. ①, Fig. 101 avec précaution.
Il est conseillé d'utiliser l'outil réf. 27516000
(pour les versions avec Ø Piston : 40 - 45 - 50) ou
réf. 27516100 (pour les versions avec Ø Piston :
55 - 60 - 65) pour éviter de couper le joint torique
en phase d'installation.

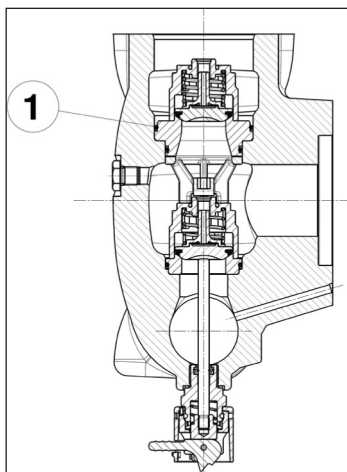

Fig. 101

Insérer la bague du logement de la soupape (rep. ①, Fig. 102) et le ressort (rep. ①, Fig. 103).

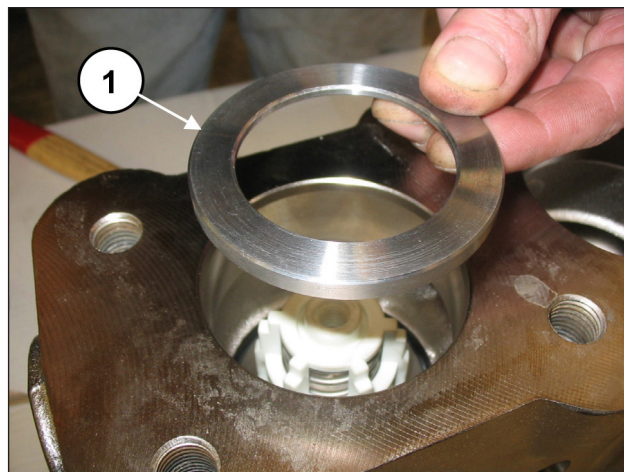

Fig. 102

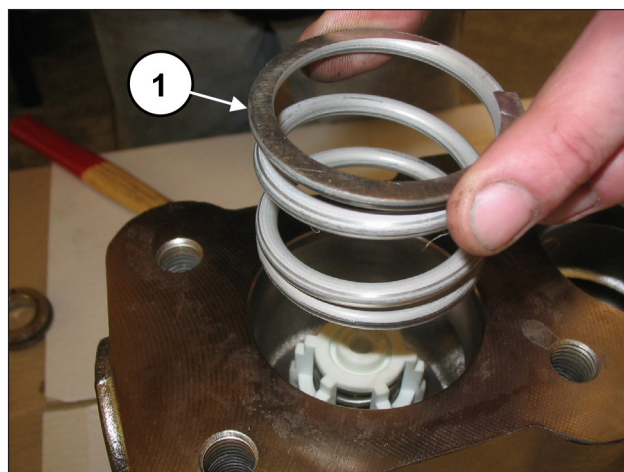

Fig. 103

Monter le joint torique, rep. vue éclatée 17 (rep. ①, Fig. 104) et la bague anti-extrusion, rep. vue éclatée 21 (rep. ②, Fig. 104) sur le bouchon de la soupape de refoulement.

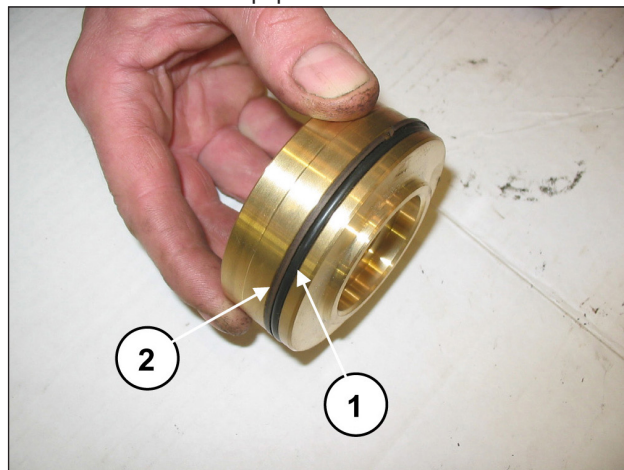

Fig. 104

Insérer le bouchon de la soupape avec le joint torique et la bague anti-extrusion.
Après avoir monté les groupes soupape et le bouchon de la soupape, poser le couvercle des soupapes (rep. ①, Fig. 105) et serrer les 8 vis M16x55 (rep. ①, Fig. 106).

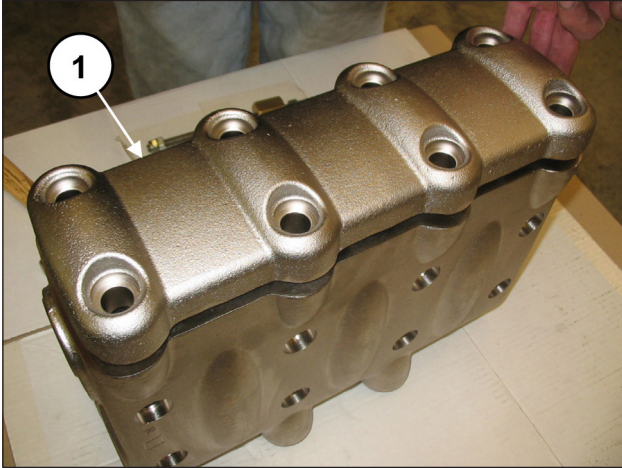

Fig. 105

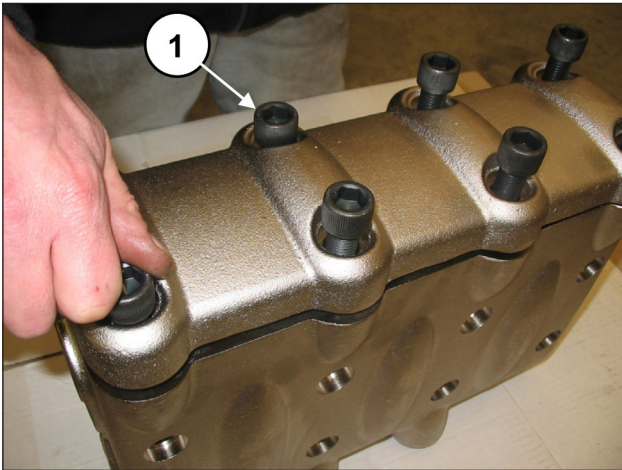

Fig. 106

Monter la tête sur le carter de pompe (rep. ①, Fig. 107) en ayant soin de ne pas heurter les pistons puis visser les 8 vis M16x180 (rep. ①, Fig. 108).

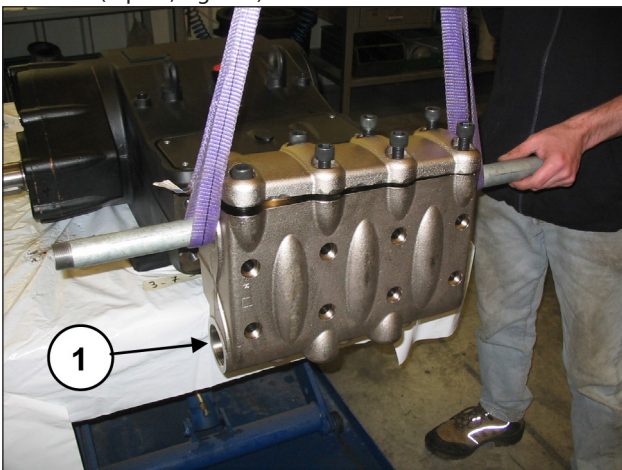

Fig. 107

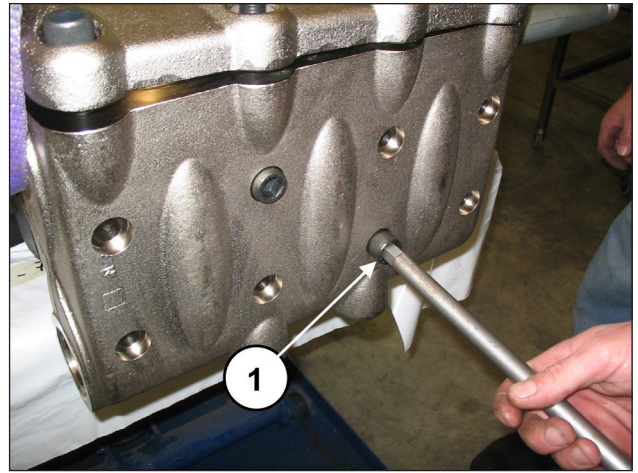

Fig. 108

Serrer les vis M16x180 à l'aide d'une clé dynamométrique, en suivant les explications du chapitre 3.



Serrer les 8 vis M16x180 en partant des 4 vis internes et en les croisant (voir Fig. 107), puis passer aux 4 vis externes, toujours en croix.

Serrer les vis M16x55 du couvercle à l'aide d'une clé dynamométrique, en suivant les explications du chapitre 3. Appliquer les dispositifs d'ouverture des soupapes (rep. ①, Fig. 109) et les serrer à l'aide d'une clé de 30 mm (rep. ①, Fig. 110).

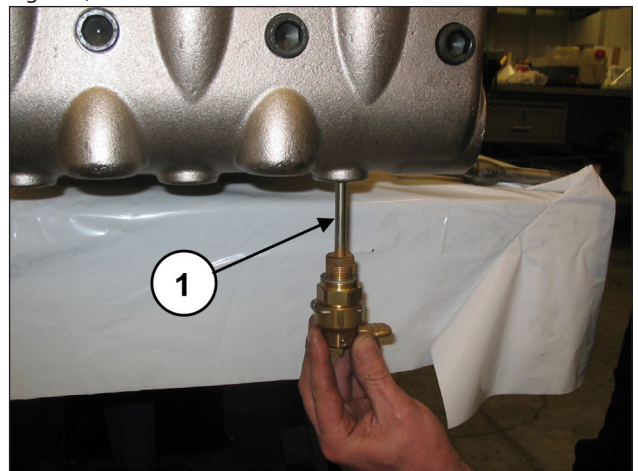

Fig. 109

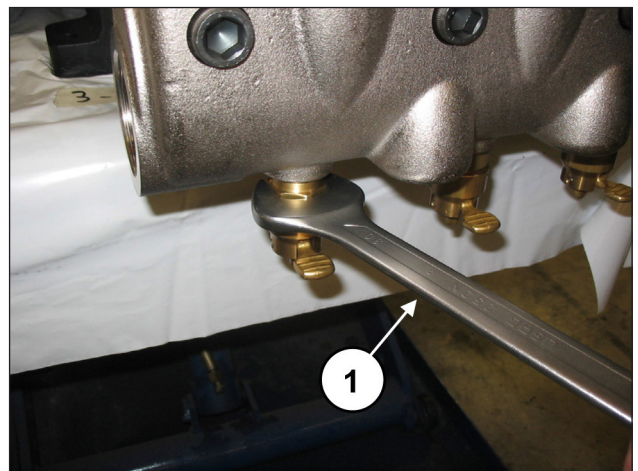

Fig. 110

2.2.3 Démontage du groupe piston - supports - joints d'étanchéité

Le groupe piston nécessite un contrôle périodique comme l'indique le tableau d'entretien préventif du **Manuel d'utilisation et d'entretien**.

Les interventions se limitent à un contrôle visuel du drainage éventuel à travers l'orifice présent sur le couvercle inférieur. En cas d'anomalies / oscillations sur le manomètre de refoulement ou d'égouttement à travers l'orifice de drainage, procéder à un contrôle et remplacer éventuellement le lot de joints.

Pour l'extraction des groupes du piston, procéder de la façon suivante :

Pour accéder au groupe piston, desserrer les vis M16x180 et démonter la tête.



Dégager la tête avec précaution pour éviter de heurter les pistons.

Démonter les pistons en desserrant les vis de fixation (rep. ①, Fig. 111).

Dégager le piston du support des joints et contrôler que la surface du piston ne présente aucune rayure, aucun signe d'usure ou de cavitation.

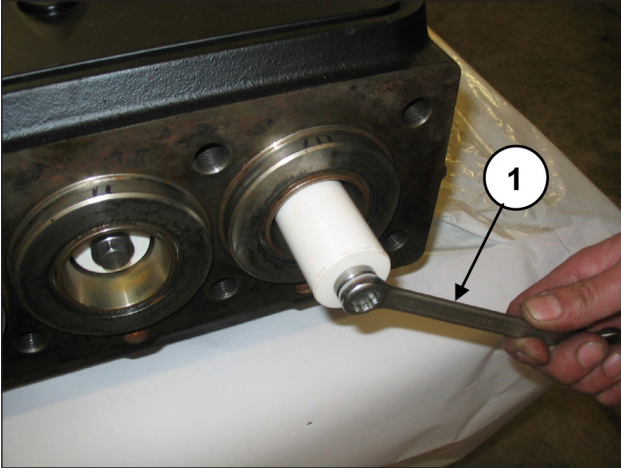

Fig. 111

Déposer le couvercle d'inspection supérieur en desserrant les 4 vis de fixation (rep. ①, Fig. 112).

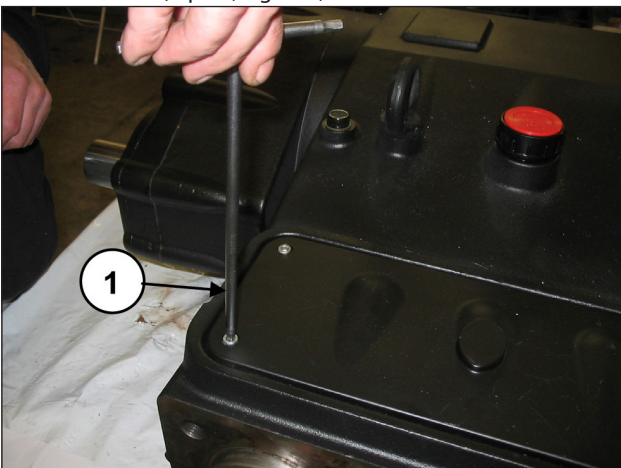

Fig. 112

Tourner manuellement l'arbre de sorte que les 3 pistons se trouvent en position de point mort supérieur.

Insérer l'outil tampon réf. 27516600 entre le guide du piston et le piston (rep. ①, Fig. 113).

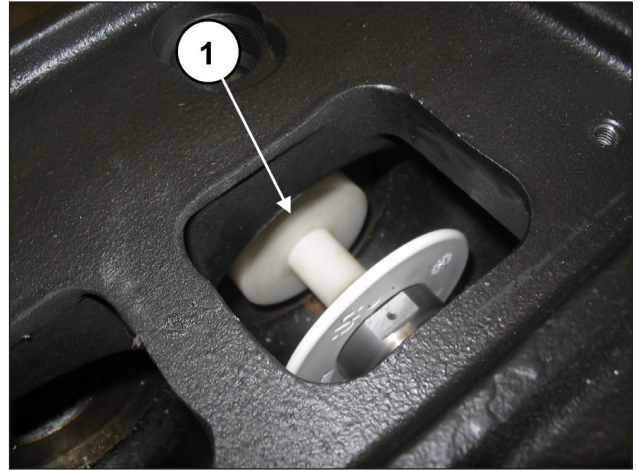

Fig. 113

Tourner l'arbre pour faire avancer le guide du piston de sorte que le tampon, en avançant à son tour, puisse chasser le support des joints et le groupe piston complet (rep. ①, Fig. 114).

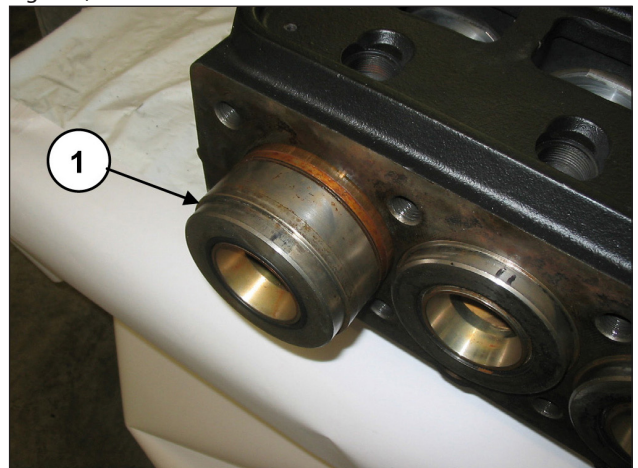

Fig. 114

Dégager le groupe support des joints et l'outil tampon. Déposer le joint torique du fond du support des joints au cas où il serait resté à l'intérieur du carter de pompe (rep. ①, Fig. 115).

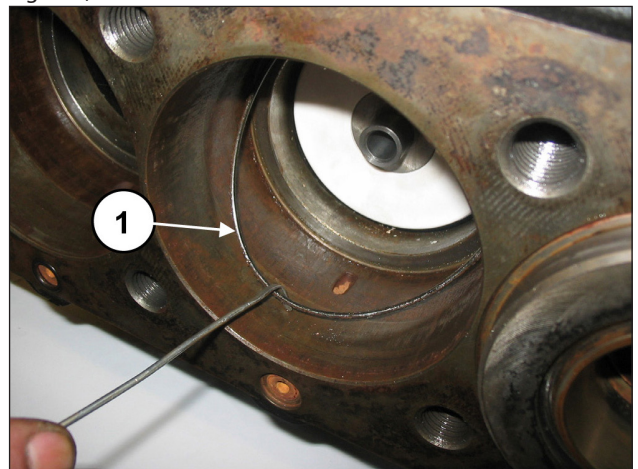

Fig. 115

Dégager les joints anti-éclaboussure des guides de pistons (rep. ①, Fig. 116).

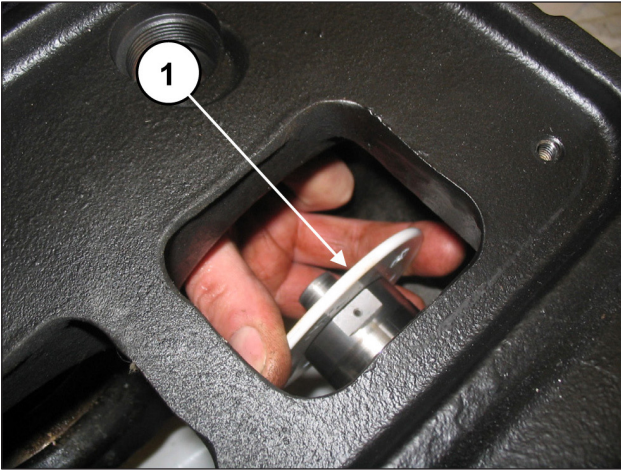

Fig. 116

S'il s'avère nécessaire de remplacer le joint d'huile du guide de piston, démonter le couvercle du joint d'huile en procédant de la façon suivante :

Dévisser les deux vis de retenue du couvercle du joint d'huile (rep. ①, Fig. 117).

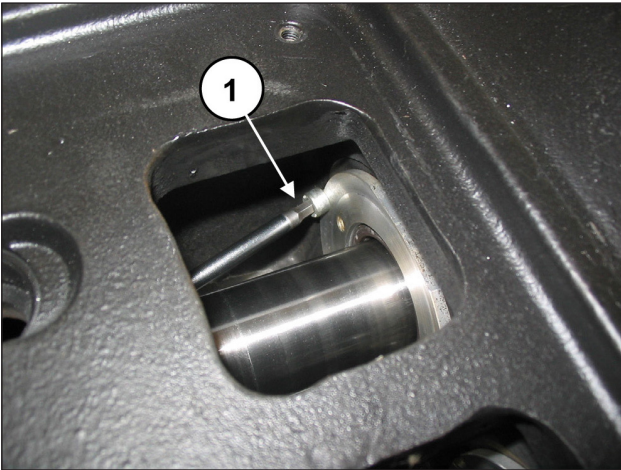

Fig. 117

Mettre le guide de piston au point mort inférieur, visser l'extracteur réf. 27516400 avec l'adaptateur M5 réf. 27516500 dans les orifices présents sur le couvercle (rep. ①, Fig. 118) et dégager le couvercle du joint d'huile du groupe pompe (rep. ①, Fig. 119).

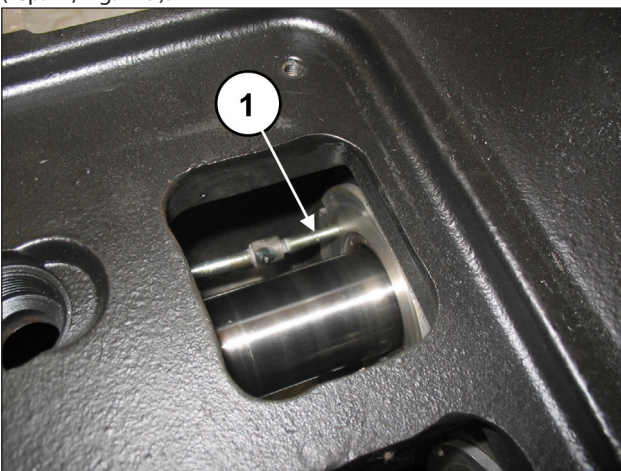

Fig. 118

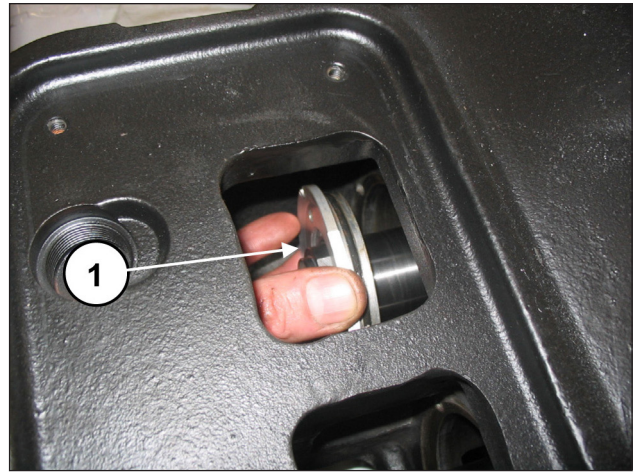

Fig. 119

Remplacer le joint d'huile (rep. ①, Fig. 120) et le joint torique extérieur (rep. ②, Fig. 120).

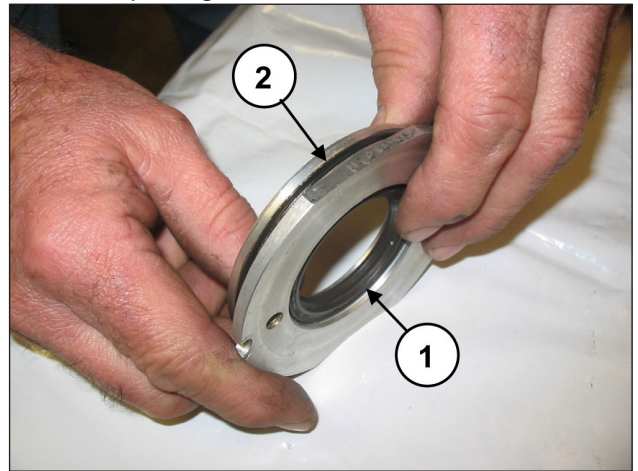

Fig. 120

Désassembler le support des joints de la chemise (rep. ①, Fig. 121) pour accéder aux joints de pression (rep. ①, Fig. 122).

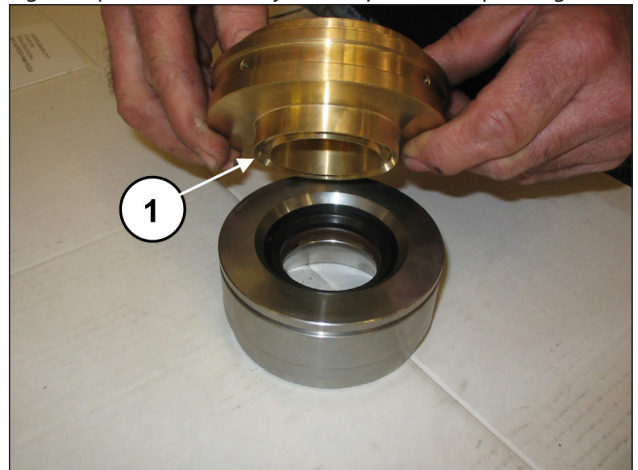

Fig. 121

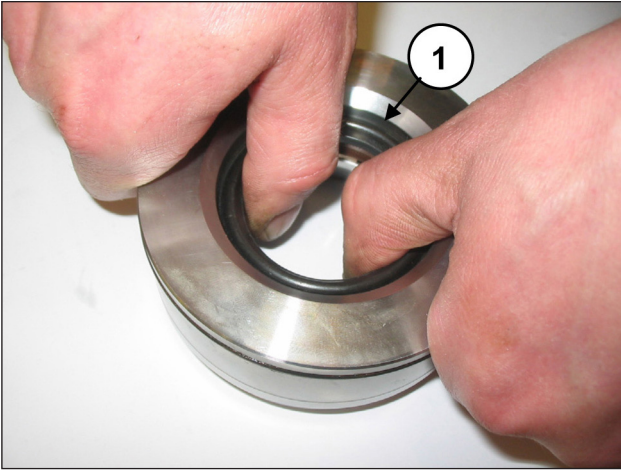

Fig. 122

Pour ôter le joint de basse pression, utiliser une jauge d'épaisseur ou un outil qui n'endommage pas le siège du support du joint (rep. ①, Fig. 123).

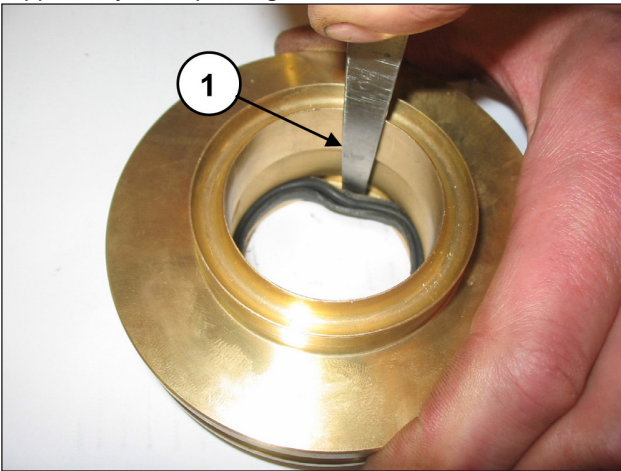

Fig. 123

2.2.4 Montage du groupe piston - supports - joints d'étanchéité

Procéder au remontage en inversant les opérations de démontage du parag. 2.2.3.



Remplacer les joints de pression en humectant les lèvres de graisse à base de silicone (ne pas les enduire) et en ayant soin de ne pas les endommager en les insérant dans la chemise.



Remplacer les joints de pression et les joints toriques à chaque opération de démontage.

Insérer le joint de basse pression dans le support du joint (rep. ①, Fig. 124) en contrôlant le sens de montage qui prévoit que la lèvre d'étanchéité soit tournée en avant (vers la tête).

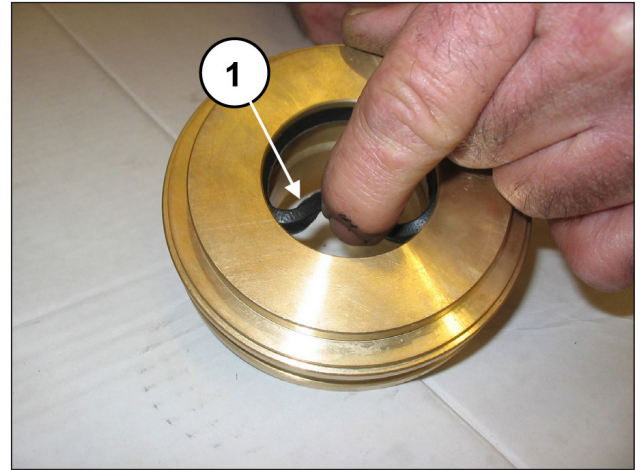

Fig. 124

Monter l'anneau de tête (rep. ①, Fig. 125), le joint de haute pression (rep. ①, Fig. 126) et l'anneau restop (rep. ①, Fig. 127).



Fig. 125

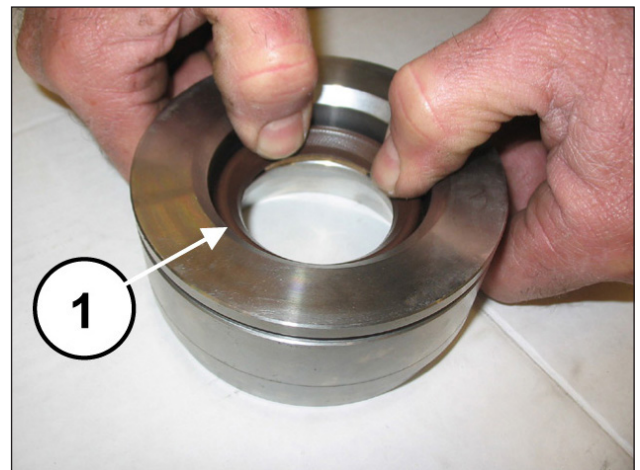

Fig. 126



Fig. 127

Assembler le support des joints à la chemise (rep. ①, Fig. 128).

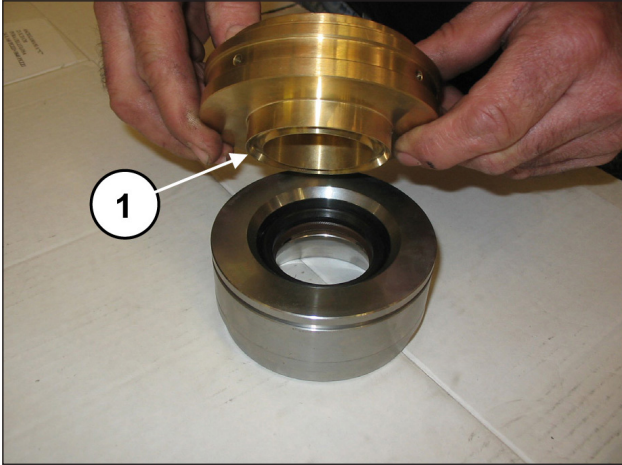

Fig. 128

Monter le joint d'huile sur le couvercle (rep. ①, Fig. 129) à l'aide d'un tampon réf. 27910900.

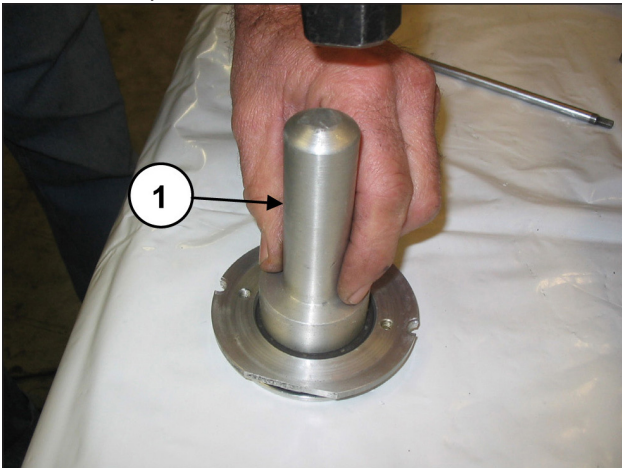

Fig. 129

Placer le joint torique (rep. ①, Fig. 130) dans le siège du couvercle du joint d'huile et insérer le groupe assemblé dans le siège prévu à cet effet sur le carter (rep. ①, Fig. 131).

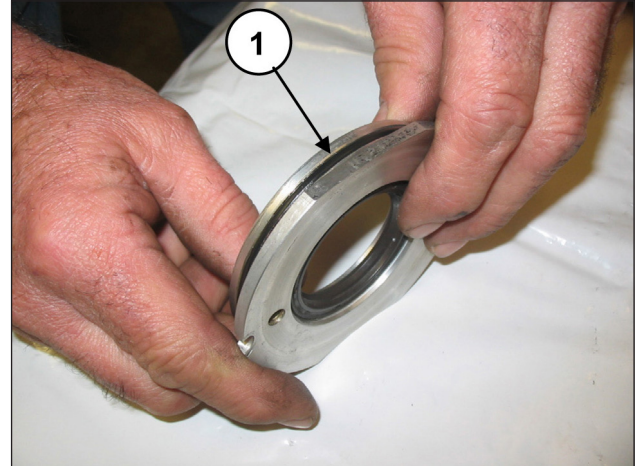

Fig. 130

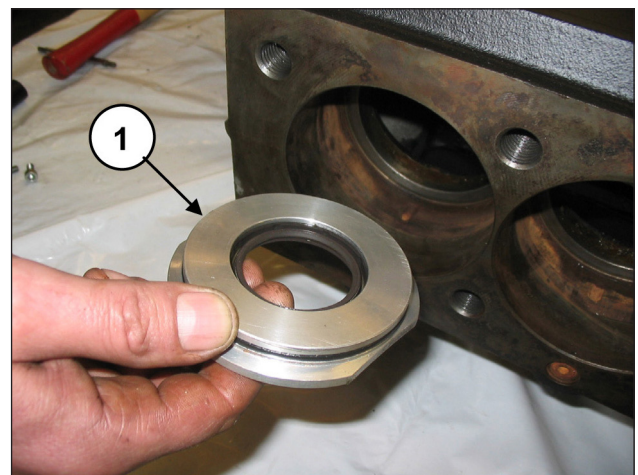

Fig. 131

S'assurer que le couvercle entre à fond dans le logement (rep. ①, Fig. 132) en ayant soin de ne pas endommager la lèvre du joint d'huile. Visser le couvercle du joint d'huile à l'aide de 2 vis M6x14 (rep. ①, Fig. 133).

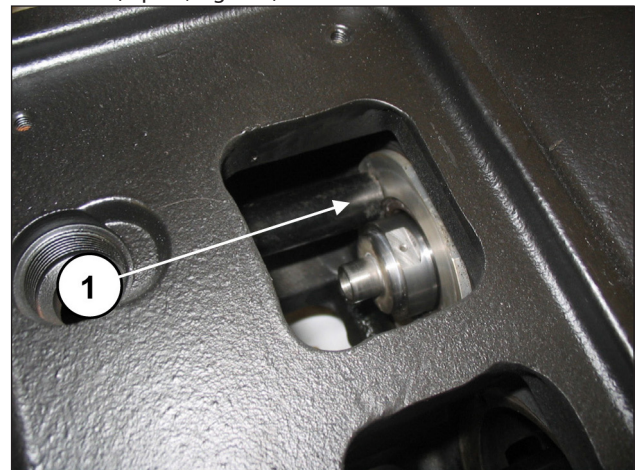

Fig. 132

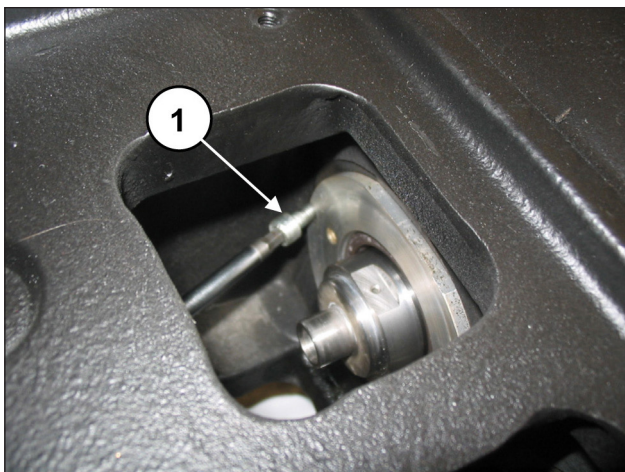

Fig. 133

Serrer les vis à l'aide d'une clé dynamométrique, en suivant les explications du chapitre 3.

Placer les bavettes avec leur joint torique dans le logement sur le guide du piston (rep. ①, Fig. 134 et Fig. 135).

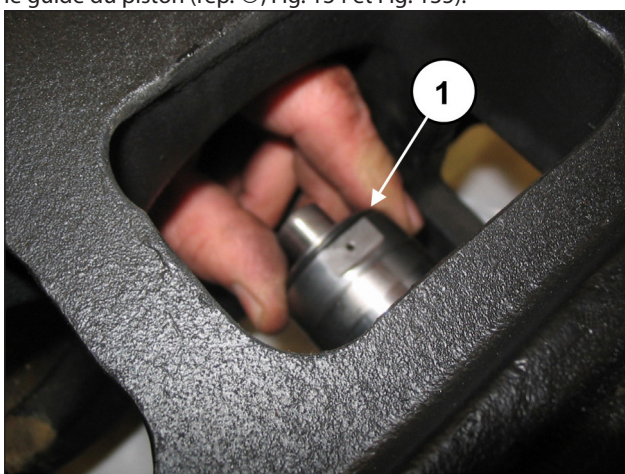

Fig. 134

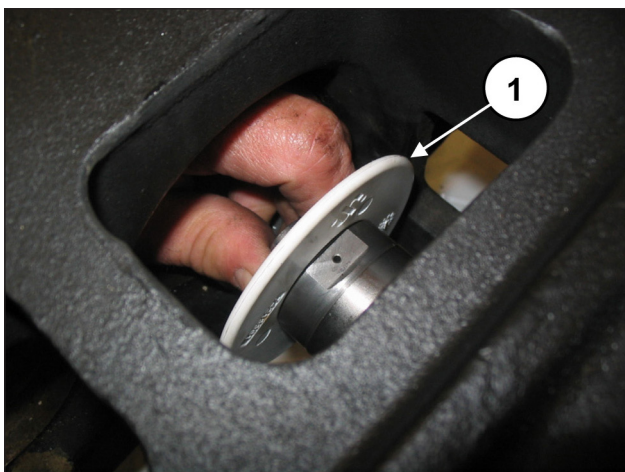

Fig. 135

Insérer la rondelle Ø10x18x0,9 dans la vis de fixation du piston (rep. ①, Fig. 136).

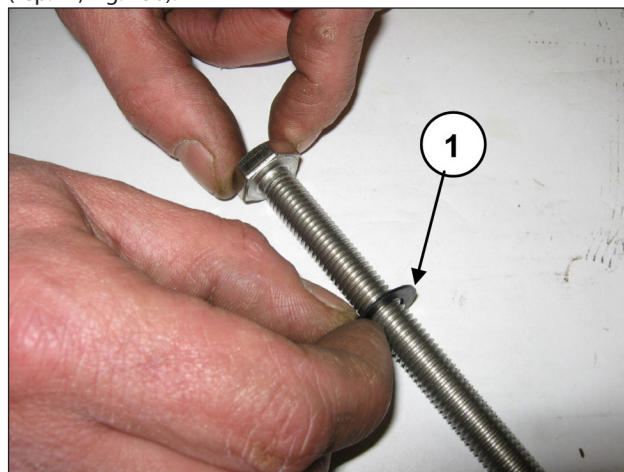

Fig. 136

Monter les pistons sur les guides correspondants (rep. ①, Fig. 137) et les fixer comme le montre le rep. ①, Fig. 138.

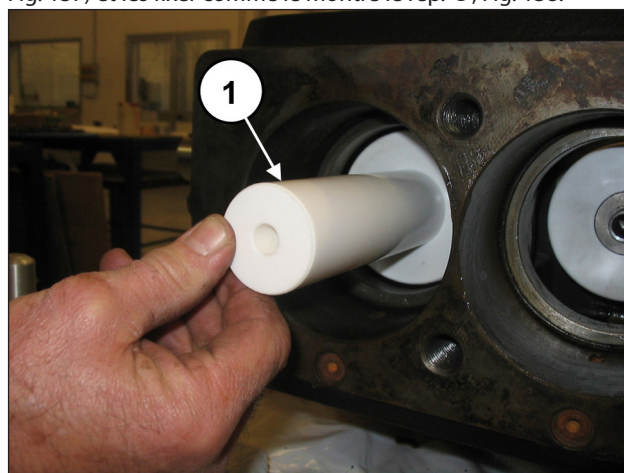

Fig. 137

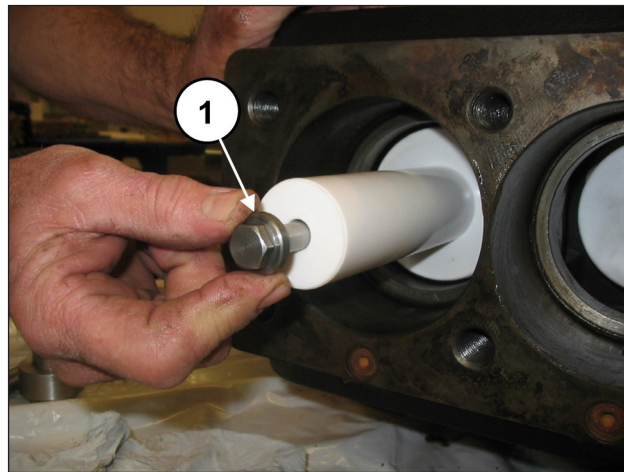

Fig. 138

Serrer les vis à l'aide d'une clé dynamométrique, en suivant les explications du chapitre 3.

Placer le joint torique dans le carter de pompe (rep. ①, Fig. 139) puis le dispositif de blocage chemise-support de joint (avec le même joint torique) préalablement assemblé et les pousser à fond (rep. ①, Fig. 140).

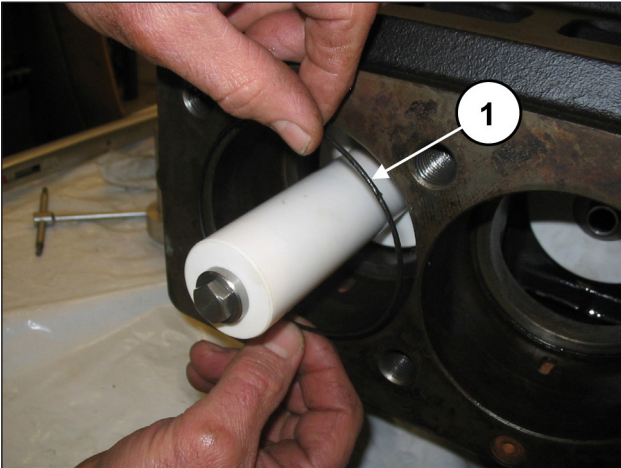

Fig. 139

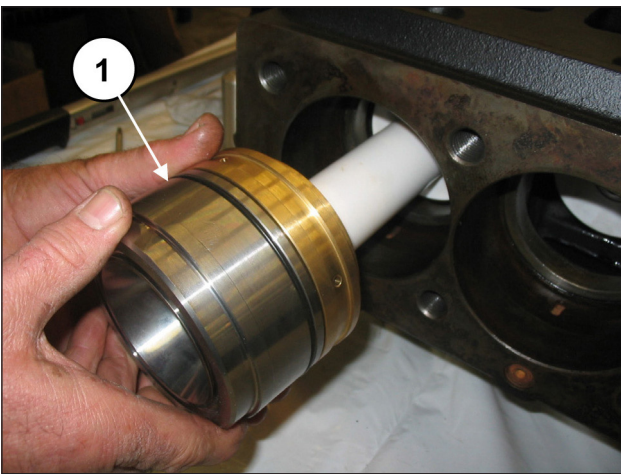

Fig. 140

S'assurer que le dispositif de blocage chemise-support se positionne correctement au fond du logement (rep. ①, Fig. 141).

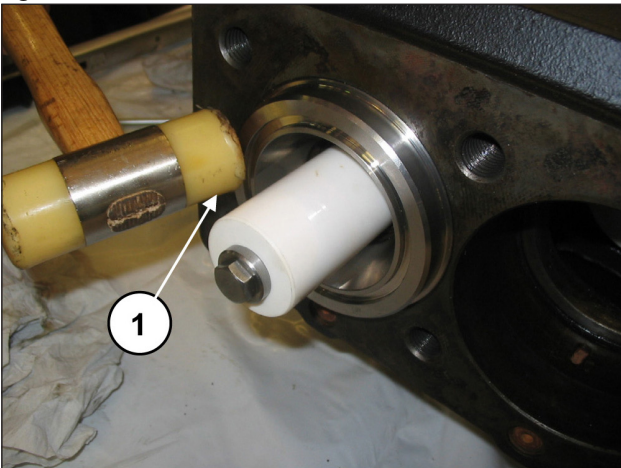

Fig. 141

Monter le joint torique à l'avant de la chemise (rep. ①, Fig. 142) et le joint torique de l'orifice de recirculation (rep. ①, Fig. 143).

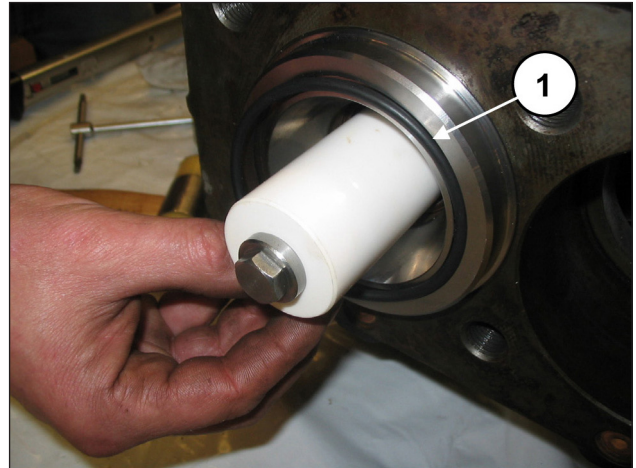

Fig. 142

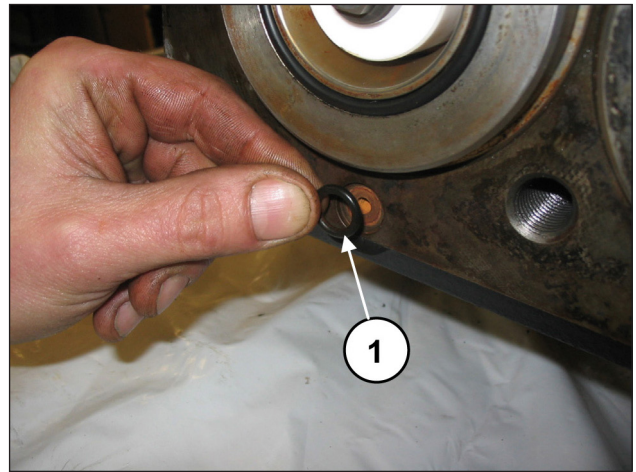

Fig. 143

Insérer le joint torique ①, Fig. 144) sur les couvercles et monter les couvercles à l'aide de 4+4 vis M6x14 (rep. ①, Fig. 145).

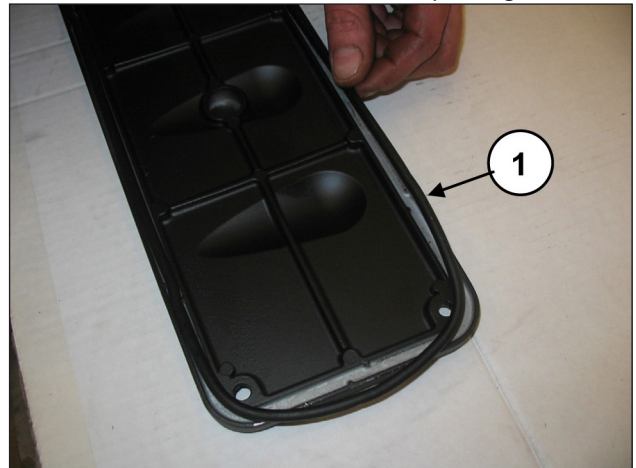

Fig. 144

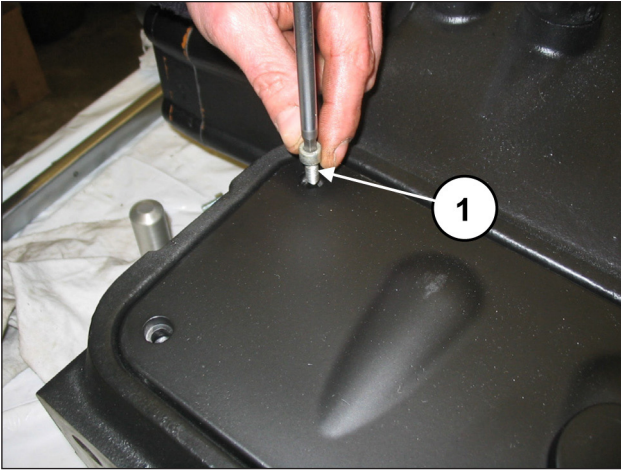

Fig. 145

Serrer les vis à l'aide d'une clé dynamométrique, en suivant les explications du chapitre 3.

2.2.5 Récupération des têtes

Si les chambres des pistons de la tête présentent des signes de cavitation dus à une alimentation incorrecte de la pompe, il est possible de récupérer la tête endommagée pour éviter de la remplacer.

Pour récupérer la tête, procéder aux usinages indiqués Fig. 146 pour les versions avec piston $\varnothing 40-45-50$ et Fig. 147 pour les versions avec piston $\varnothing 55-60-65$:

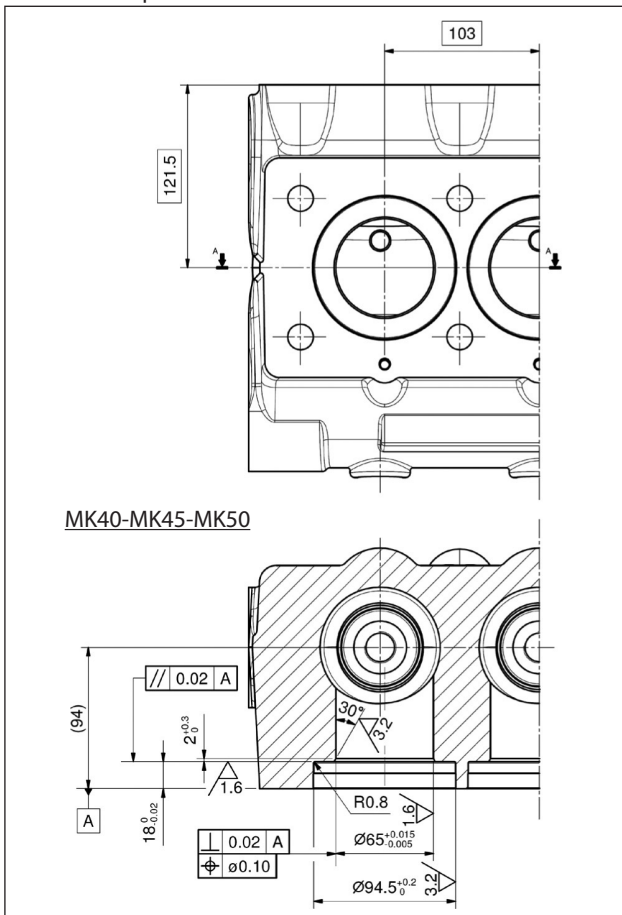

Fig. 146

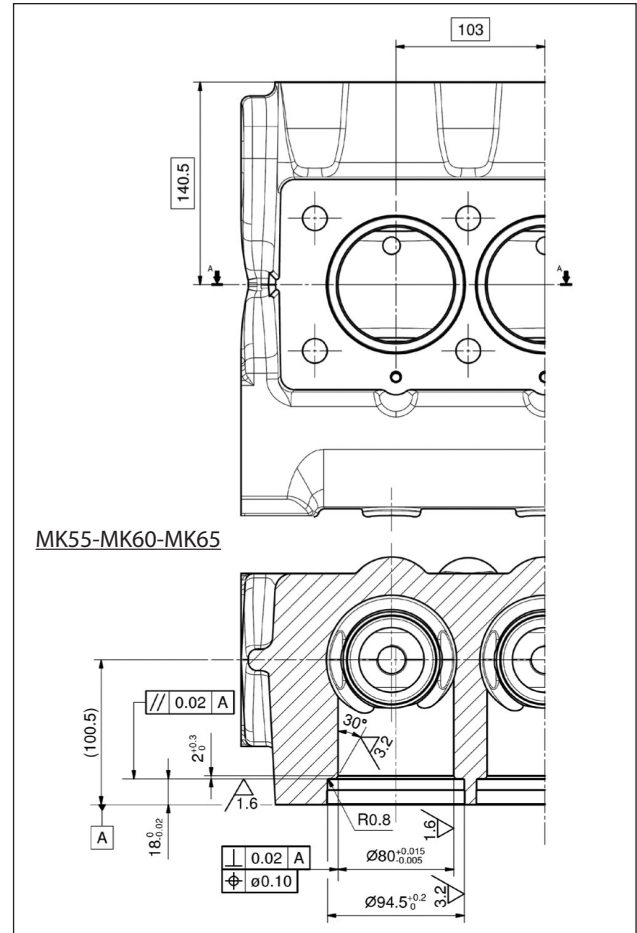

Fig. 147

Après l'avoir usinée, assembler la tête en calant les douilles (rep. ①) dotées de bagues anti-extrusion (rep. ②) et de joint torique (rep. ③) comme le montre la Fig. 148 pour les versions avec piston $\varnothing 40-45-50$ et la Fig. 149 pour les versions avec piston $\varnothing 55-60-65$:

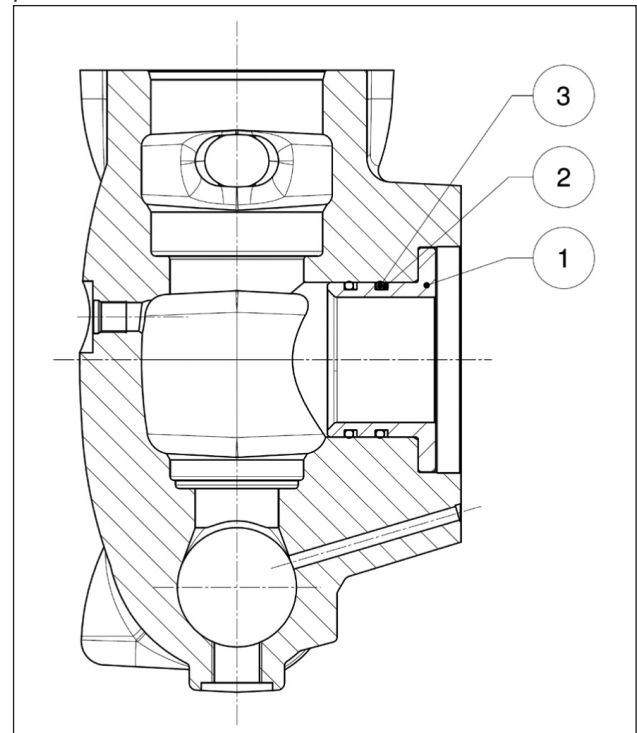

Fig. 148

- 1 - Bague pour versions avec piston $\varnothing 40-45-50$ réf. 74215156 - qté 3
- 2 - Bague anti-extrusion - réf. 90526880 - qté 6
- 3 - Joint torique - réf. 90410200 - qté

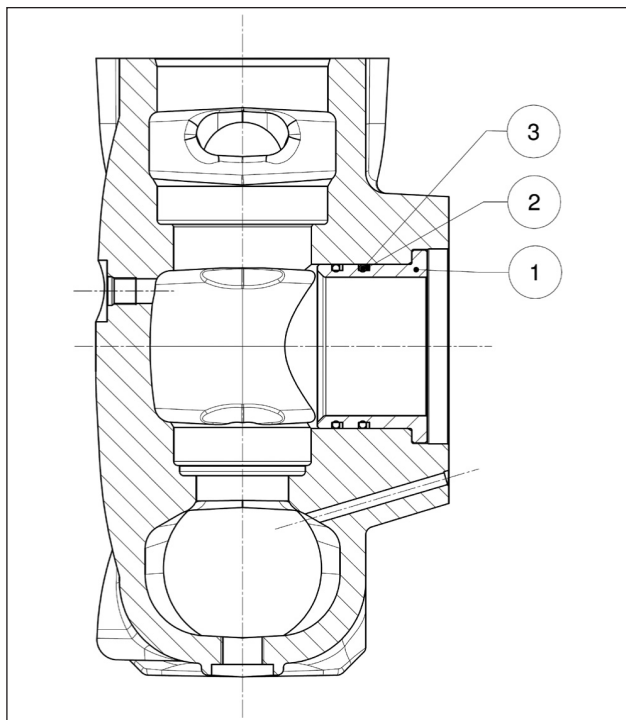

Fig. 149

1 - Bague versions avec piston Ø55-60-65 réf.74215056 - qté 3

2 - Bague anti-extrusion - réf.90528500 - qté 6

3 - Joint torique - réf. 90412900 - qté 6

3 FORCES DE SERRAGE DES VIS

Pour serrer les vis, utiliser exclusivement une clé dynamométrique.

Description	Repère vue éclatée	Couple de serrage Nm
Vis M8x18 couvercle carter	54	20
Bouchon G1/2x13 carter	55	40
Vis M8x18 flasque réducteur	54	20
Vis M10x50 couvercle réducteur	70	45
Vis M10x25 arrêt couronne	65	45
Vis M12x40 boîtier réducteur	75	73.5
Vis M12x50 boîtier réducteur	64	73.5
Vis M6x14 couvercles sup. et inf.	41	10
Vis M12x30 couvercle coussinet	90	40
Vis M12x1,25x87 serrage bielle	53	75*
Vis M6x20 guide piston	49	10
Vis M6x14 couvercle joint d'huile	41	10
Vis M10x160 fixation piston	27	40
Vis M16x55 couvercle soupapes	26	333
Bouchon G1/4"x13 tête	13	40
Vis M16x180 tête	25	333**
Dispositif ouverture soupapes	2	40

* Obtenir le couple de serrage en serrant les vis simultanément

** Serrer les vis en partant des 4 vis internes et en les croisant (voir Fig. 108), puis passer aux 4 vis externes, toujours en croix.

4 OUTILS POUR LA RÉPARATION

Pour l'entretien de la pompe, il est possible d'utiliser des outils traditionnels pour le démontage et le remontage des composants. Les outils suivants sont disponibles :

Pour le montage :

Joint d'huile guide piston	réf. 27910900
Joint d'huile pignon	réf. 27515900
	réf. 27548200
Joint torique siège soupape de refoulement versions avec piston Ø40-45-50	réf. 27516000
Joint torique siège soupape de refoulement versions avec piston Ø55-60-65	réf. 27516100

Pour le démontage :

Siège soupape d'aspiration versions avec piston Ø40-45-50	réf. 27516200
Siège soupape d'aspiration versions avec piston Ø55-60-65	réf. 27516300
Siège soupape refoulement	réf. 27516400
Couvercle joint d'huile	réf. 27516400
	réf. 27516500
Bloc chemise + support joints	réf. 27516600
Couvercle réducteur	réf. 27516700
Arbre (blocage des bielles)	réf. 27566200

5 REMPLACEMENT DE LA DOUILLE PIED DE LA BIELLE

Procéder au calage du coussinet à froid et aux usinages suivants en respectant les dimensions et les tolérances de la Fig. 150 ci-dessous.

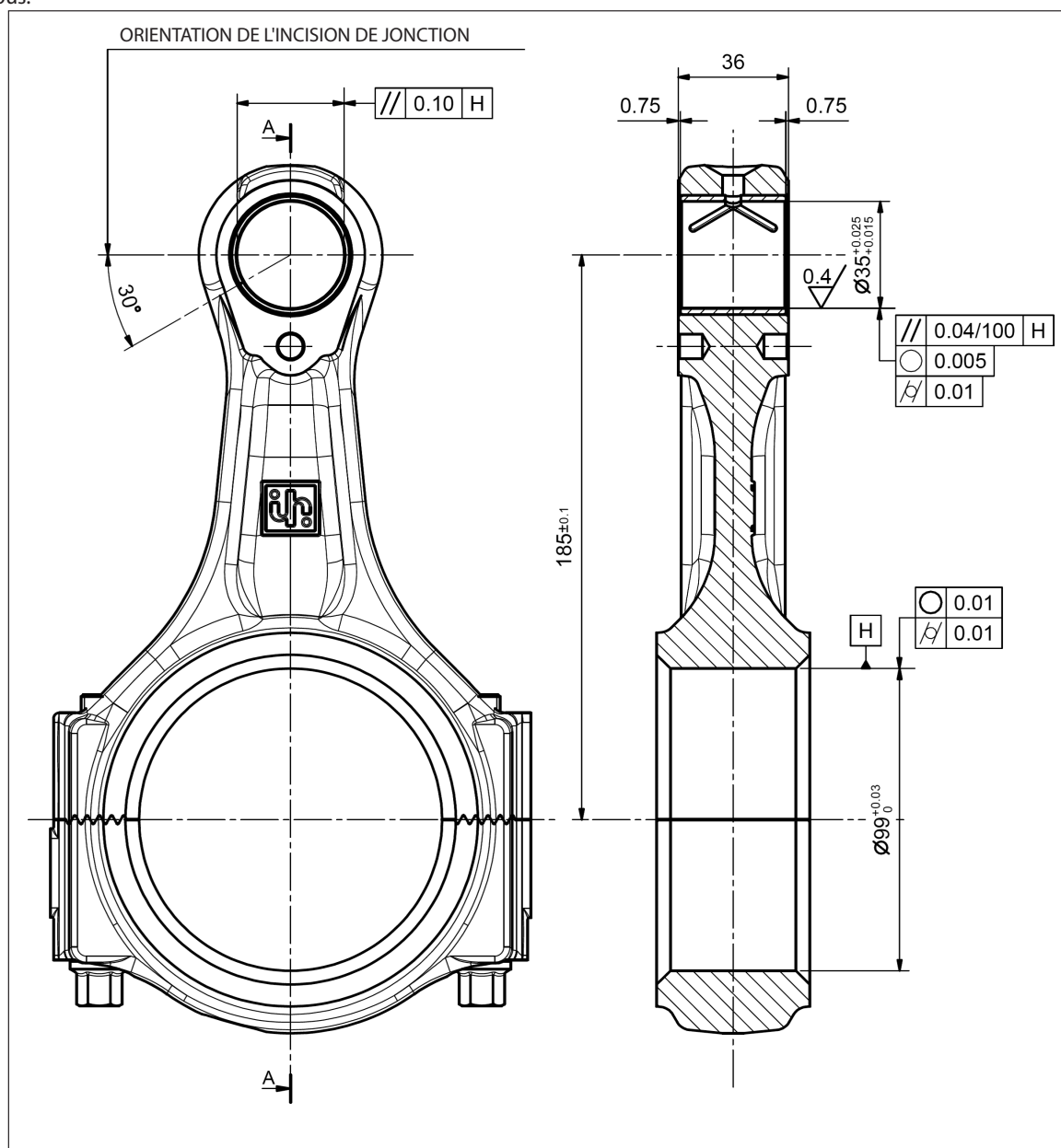

Fig. 150

6 VERSIONS SPÉCIALES

Suivent les indications concernant la réparation des versions spéciales. Sauf indications contraires, respecter les instructions concernant la pompe MK-MKS version standard.

- Pompes MKC - MKSC : pour la réparation, suivre les indications valables pour la pompe MK-MKS version standard.
- Pompes MKR - MKSR : pour la réparation, suivre les indications valables pour la pompe MK standard, à l'exception des joints de pression auxquels sont dédiés les paragraphes suivants.

6.1 DÉMONTAGE DU GROUPE PISTON - SUPPORTS - JOINTS D'ÉTANCHÉITÉ

Le groupe piston nécessite un contrôle périodique comme l'indique le tableau d'entretien préventif du **Manuel d'utilisation et d'entretien**.

Les interventions se limitent à un contrôle visuel du drainage éventuel à travers l'orifice présent sur le couvercle inférieur.

En cas d'anomalies / oscillations sur le manomètre de refoulement ou d'égouttement à travers l'orifice de drainage, procéder à un contrôle et remplacer éventuellement le lot de joints.

Pour l'extraction des groupes du piston, procéder de la façon suivante :

Pour accéder au groupe piston, desserrer les vis M16x180 et démonter la tête.



Dégager la tête avec précaution pour éviter de heurter les pistons.

Démonter les pistons en desserrant les vis de fixation (rep. ①, Fig. 151).

Dégager le piston du support des joints et contrôler que la surface du piston ne présente aucune rayure, aucun signe d'usure ou de cavitation.

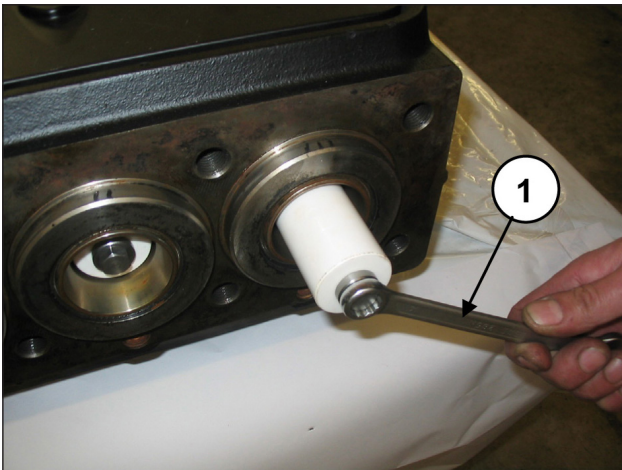

Fig. 151

Déposer le couvercle d'inspection supérieur en desserrant les 4 vis de fixation (rep. ①, Fig. 152).

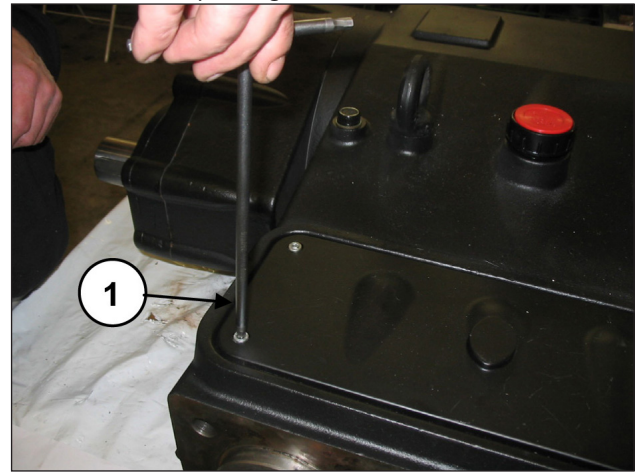

Fig. 152

Tourner manuellement l'arbre de sorte que les 3 pistons se trouvent progressivement en position de point mort supérieur puis insérer le tampon réf. 27516600 entre le guide du piston et le piston (rep. ①, Fig. 153).

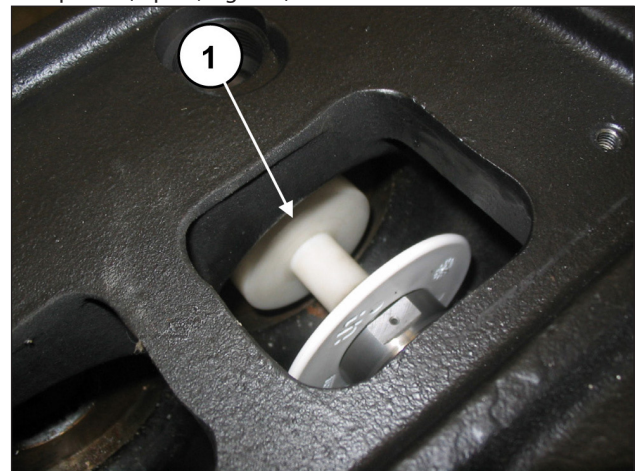

Fig. 153

Tourner l'arbre pour faire avancer le guide du piston de sorte que le tampon, en avançant à son tour, puisse chasser le support des joints, le ressort et le groupe piston complet (rep. ①, Fig. 154).

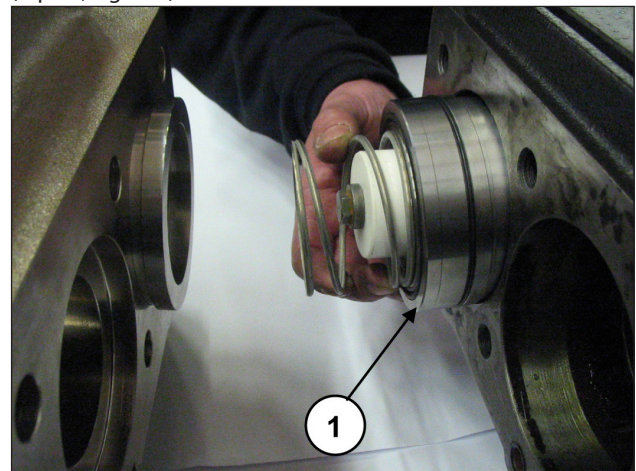

Fig. 154

Dégager le groupe support des joints et l'outil tampon.

Déposer le joint torique du fond du support des joints au cas où il serait resté à l'intérieur du carter de pompe (rep. ①, Fig. 155).

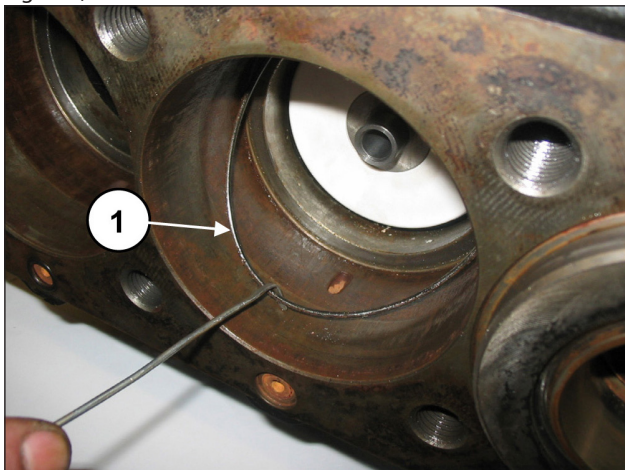

Fig. 155

Dégager les joints anti-éclaboussure des guides de pistons (rep. ①, Fig. 156).

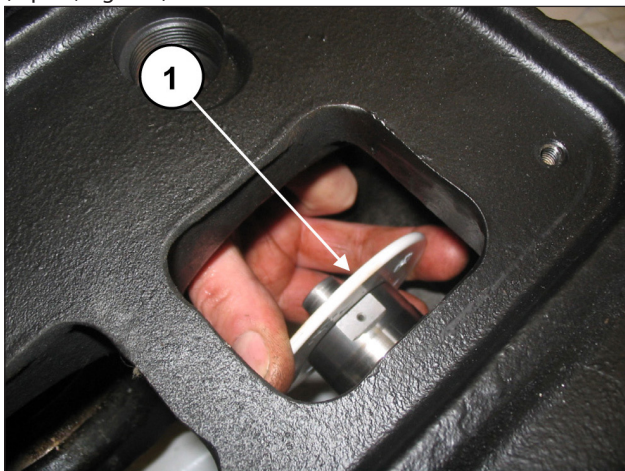

Fig. 156

S'il s'avère nécessaire de remplacer le joint d'huile du guide de piston, démonter le couvercle du joint d'huile en procédant de la façon suivante :

Dévisser les deux vis de retenue du couvercle du joint d'huile (rep. ①, Fig. 157).

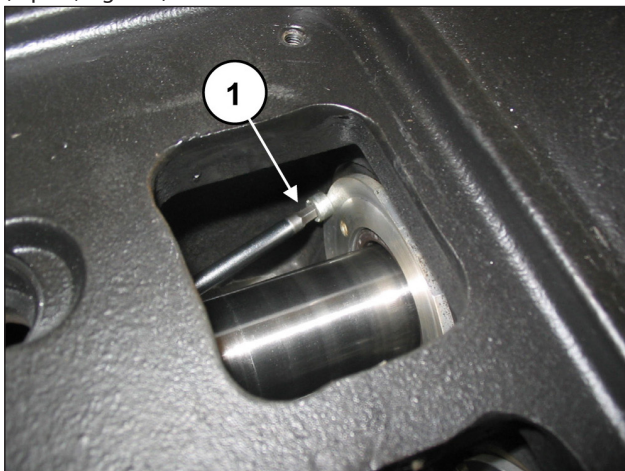

Fig. 157

Mettre le guide de piston au point mort inférieur, visser l'extracteur réf. 27516400 avec l'adaptateur M5 réf. 27516500 dans les orifices présents sur le couvercle (rep. ①, Fig. 158) et dégager le couvercle du joint d'huile du groupe pompe (rep. ①, Fig. 159).

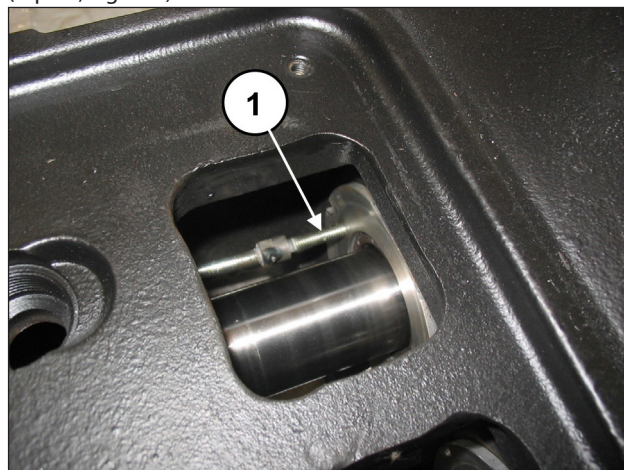

Fig. 158



Fig. 159

Remplacer le joint d'huile (rep. ①, Fig. 160) et le joint torique extérieur (rep. ②, Fig. 160).

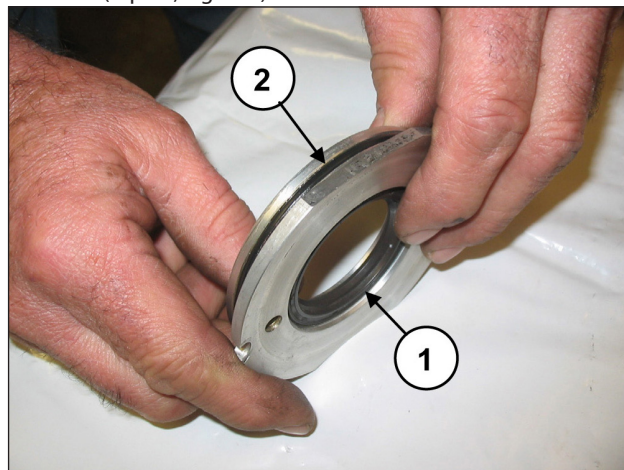

Fig. 160

Désassembler le support des joints de la chemise, ôter l'anneau du ressort et l'anneau racler (rep. ①②, Fig. 161) pour accéder aux joints de pression (rep. ①, Fig. 162).

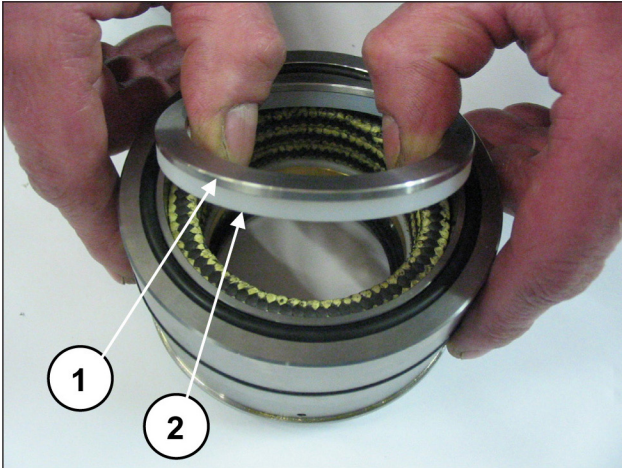

Fig. 161

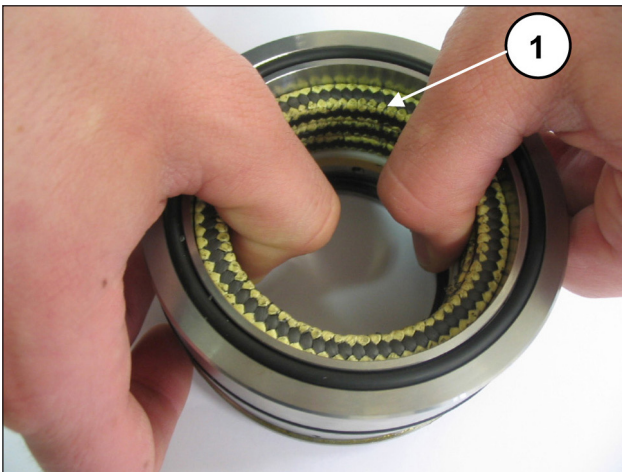

Fig. 162

Pour ôter le joint de basse pression, utiliser une jauge d'épaisseur ou un outil qui n'endommage pas le siège du support du joint (rep. ①, Fig. 163).

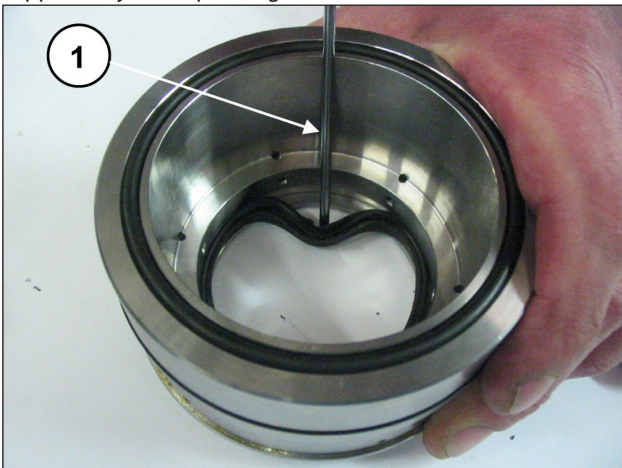

Fig. 163

6.2 MONTAGE DU GROUPE PISTON - SUPPORTS - JOINTS D'ÉTANCHÉITÉ

Procéder au remontage en inversant les opérations de démontage du parag. 6.1.



Remplacer les joints de pression en humectant les lèvres de graisse à base de silicone (ne pas les enduire) et en ayant soin de ne pas les endommager en les insérant dans la chemise.



Remplacer les joints de pression et les joints toriques à chaque opération de démontage.

Insérer le joint de basse pression dans le support presse-étoupe (rep. ①, Fig. 164) en contrôlant le sens de montage qui prévoit la lèvre d'étanchéité tournée en avant (vers la tête) et le joint torique (rep. ②, Fig. 164).

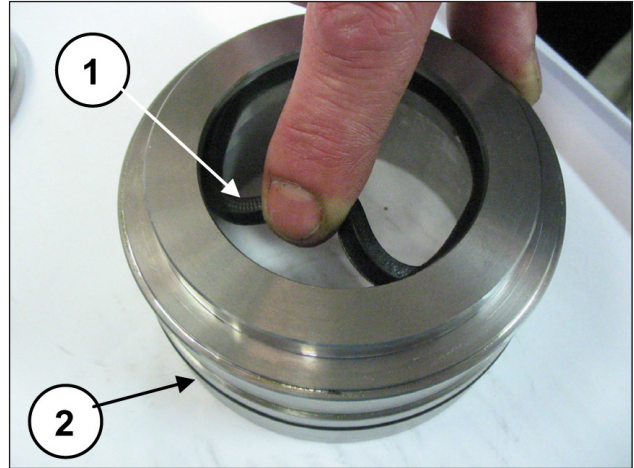

Fig. 164

Monter l'anneau de support et la bague anti-extrusion (rep. ①②, Fig. 165), les trois presse-étoupes, en s'assurant que les entailles se trouvent à 120° l'une par rapport à l'autre (rep. ①, Fig. 166), l'anneau racler des presse-étoupes et l'anneau du ressort (rep. ①②, Fig. 167).

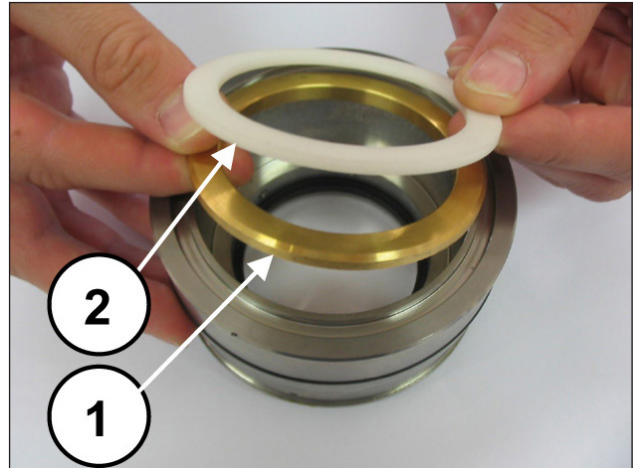

Fig. 165

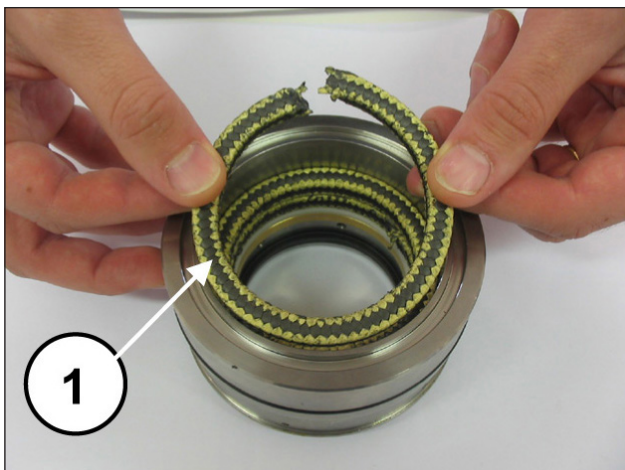

Fig. 166

Monter le joint d'huile sur le couvercle (rep. ①, Fig. 169) à l'aide d'un tampon réf. 27910900.

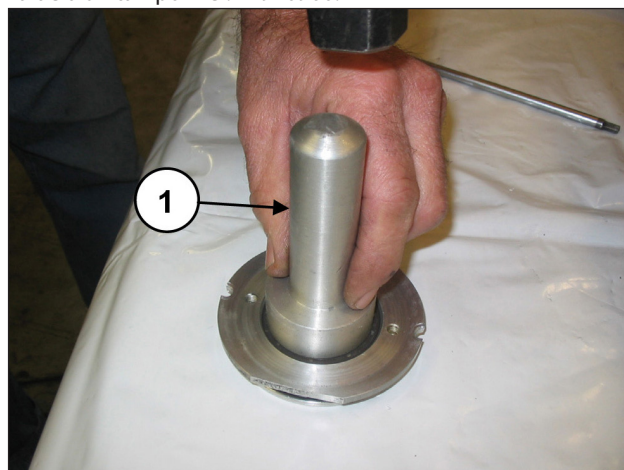

Fig. 169

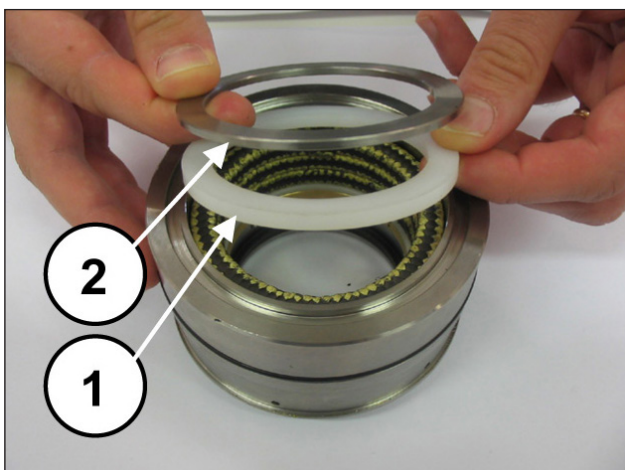

Fig. 167

Placer le joint torique (rep. ①, Fig. 170) dans le siège du couvercle du joint d'huile et insérer le groupe assemblé dans le siège prévu à cet effet sur le carter (rep. ①, Fig. 171).

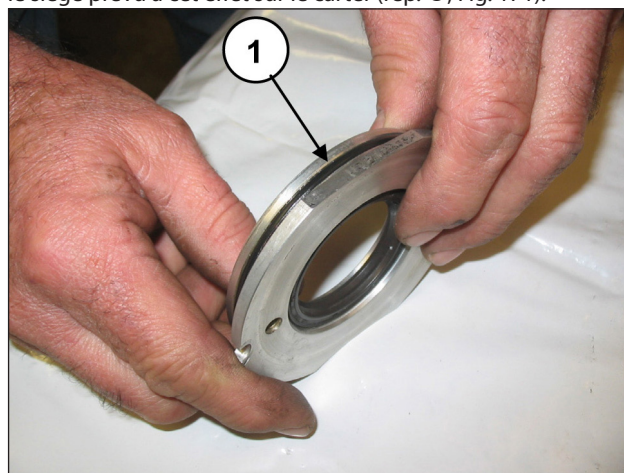

Fig. 170

Monter le joint torique (rep. ①, Fig. 168) sur l'anneau de tête du presse-étoupe et le placer dans son logement sur la tête.

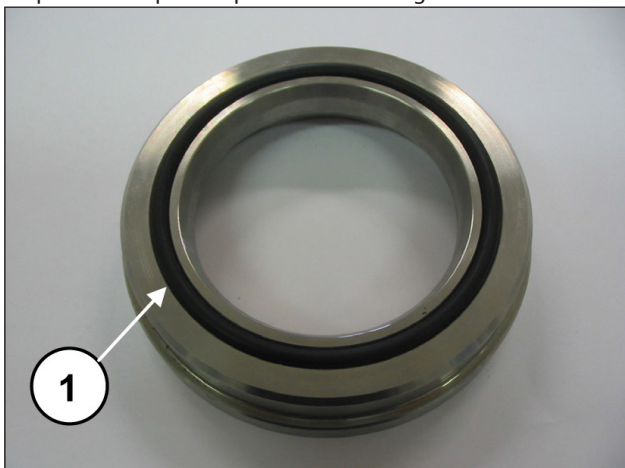

Fig. 168

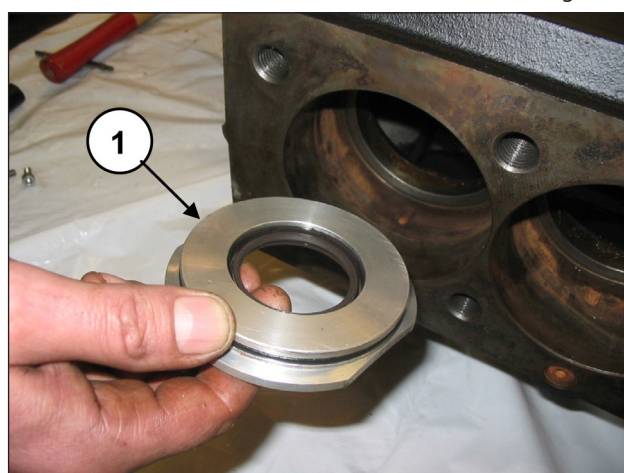

Fig. 171

S'assurer que le couvercle entre à fond dans le logement (rep. ①, Fig. 172) en ayant soin de ne pas endommager la lèvres du joint d'huile. Visser le couvercle du joint d'huile à l'aide de 2 vis M6x14 (rep. ①, Fig. 173).



Fig. 172

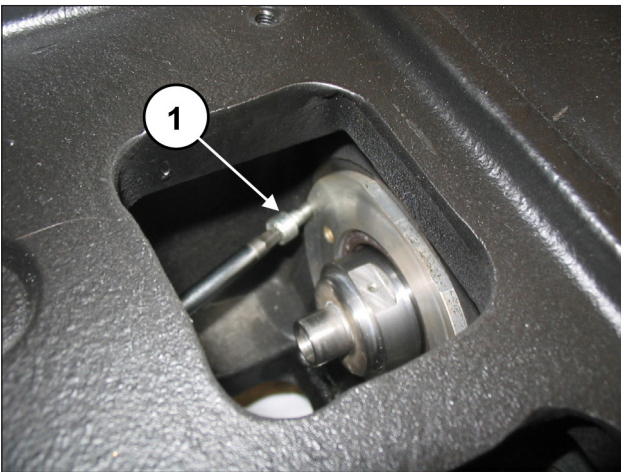

Fig. 173

Serrer les vis à l'aide d'une clé dynamométrique, en suivant les explications du chapitre 3.

Placer les bavettes avec leur joint torique dans le logement sur le guide du piston (rep. ①, Fig. 174 et Fig. 175).

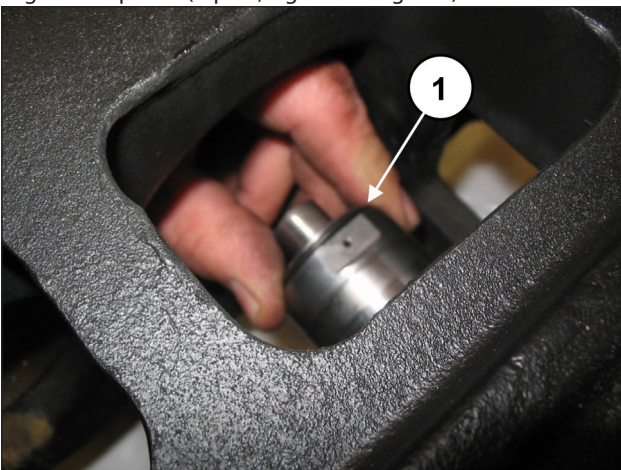

Fig. 174

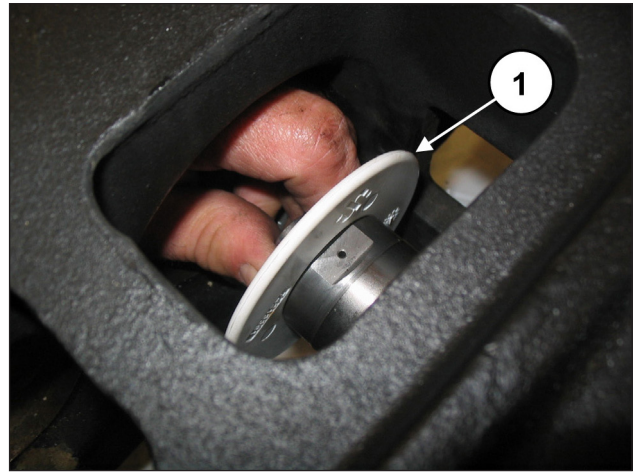

Fig. 175

Insérer la rondelle Ø10x18x0,9 dans la vis de fixation du piston (rep. ①, Fig. 176).

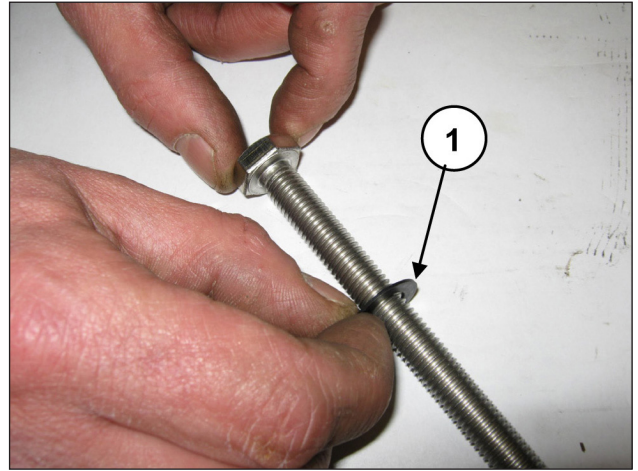

Fig. 176

Monter les pistons sur les guides correspondants (rep. ①, Fig. 177) et les fixer comme le montre le rep. ①, Fig. 178.

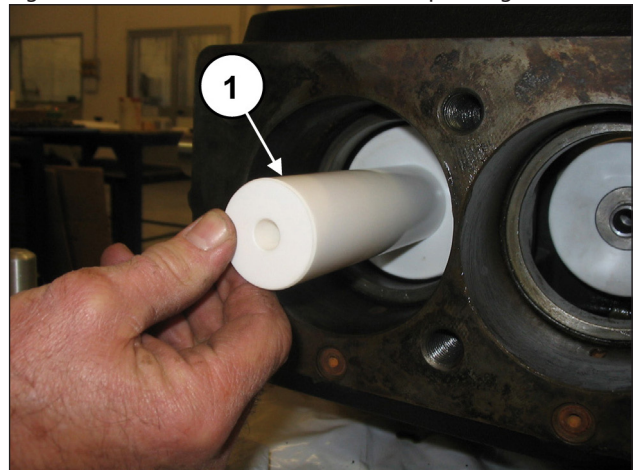

Fig. 177

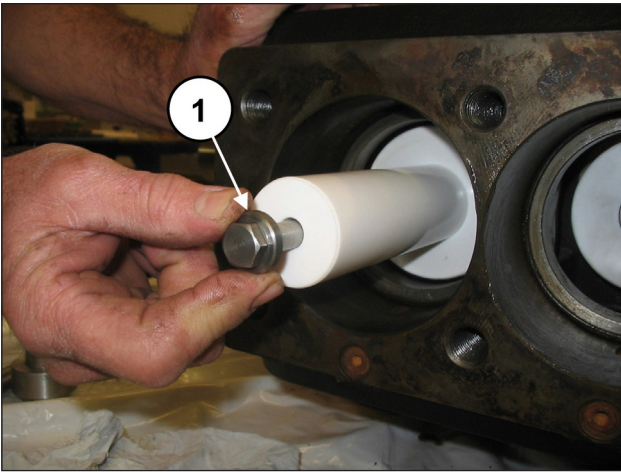

Fig. 178

Serrer les vis à l'aide d'une clé dynamométrique, en suivant les explications du chapitre 3.

Placer le joint torique dans le carter de pompe (rep. ①, Fig. 179) puis le dispositif de blocage chemise-support de joint (avec le même joint torique) préalablement assemblé et les pousser à fond (rep. ①, Fig. 180).

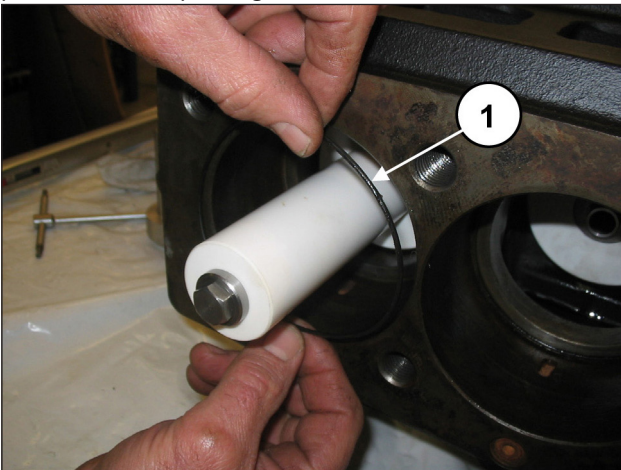

Fig. 179

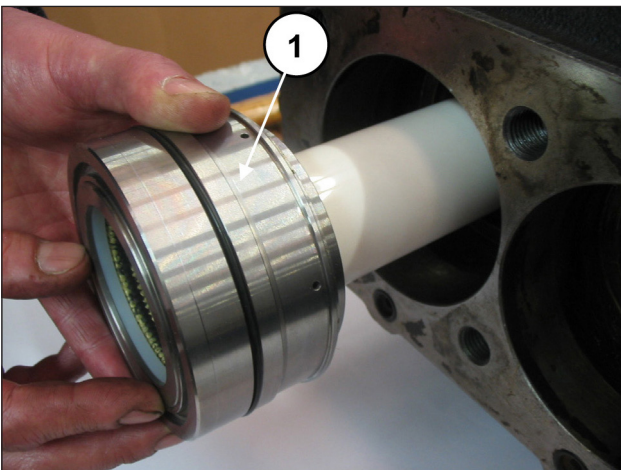

Fig. 180

S'assurer que le dispositif de blocage chemise-support se positionne correctement au fond du logement (rep. ①, Fig. 181); monter le joint torique à l'avant de la chemise et le ressort (rep. ①②, Fig. 182).

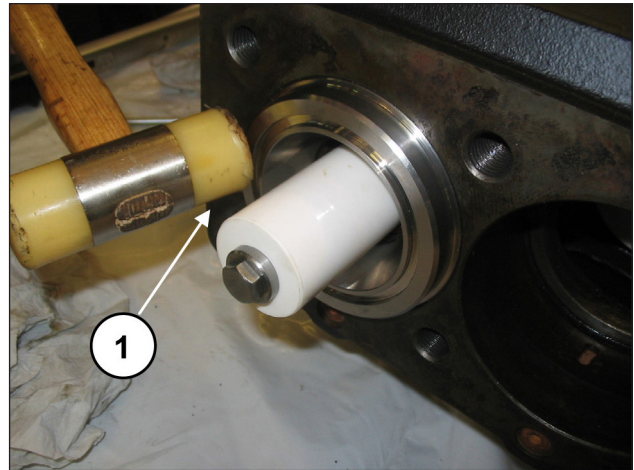

Fig. 181

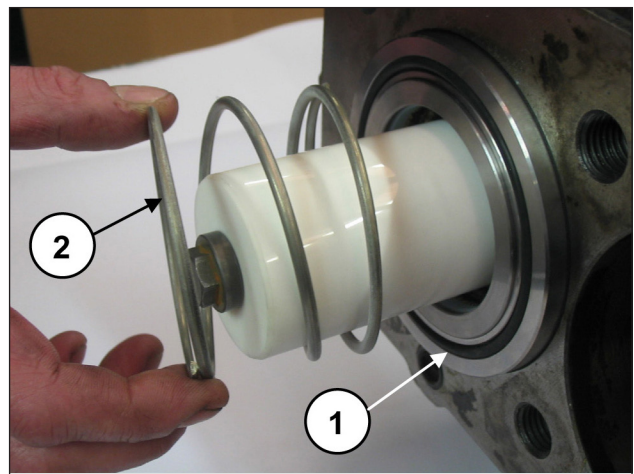

Fig. 182

Monter le joint torique de l'orifice de recirculation (rep. ①, Fig. 183).

Faciliter la stabilité du joint torique dans son siège en l'humectant légèrement de graisse.

La Fig. 184 illustre l'opération suivante correspondant au montage de la tête.

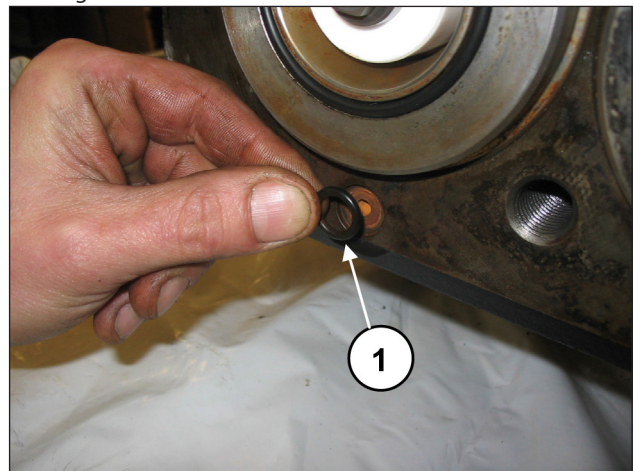

Fig. 183

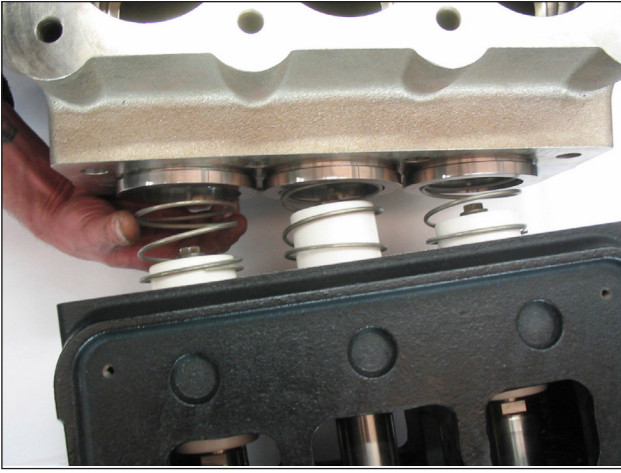

Fig. 184

Insérer le joint torique (rep. ①, Fig. 185) sur les couvercles et monter les couvercles à l'aide de 4+4 vis M6x14 (rep. ①, Fig. 186).

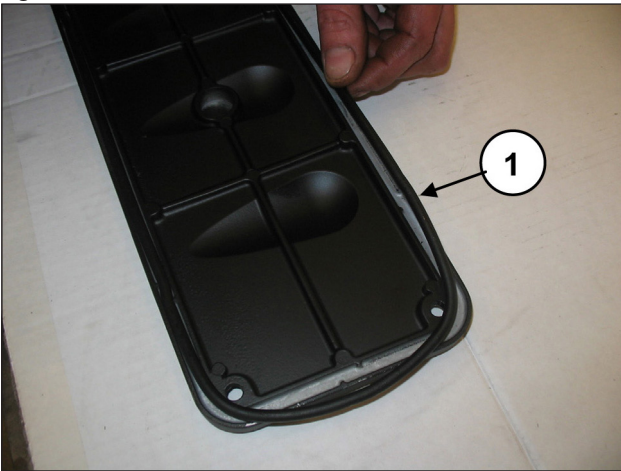

Fig. 185

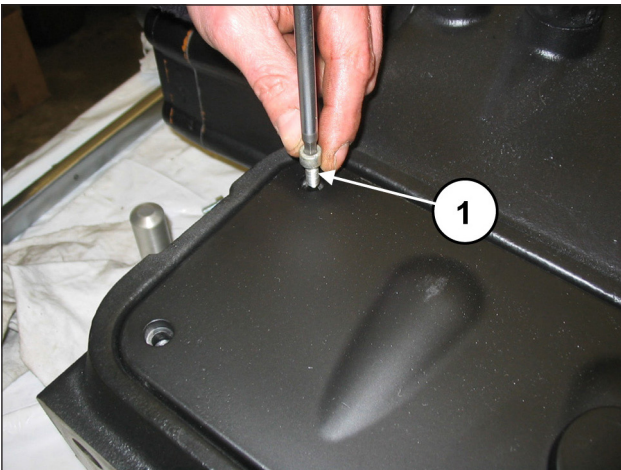

Fig. 186

Serrer les vis à l'aide d'une clé dynamométrique, en suivant les explications du chapitre 3.

Inhaltsverzeichnis

1	EINLEITUNG	116
1.1	BESCHREIBUNG DER SYMBOLE.....	116
2	REPARATURVORSCHRIFTEN	116
2.1	REPARATUR DER MECHANIK	116
2.1.1	<i>Ausbau der Mechanik</i>	116
2.1.2	<i>Einbau der Mechanik</i>	123
2.1.3	<i>Vorgesehene Übermaßklassen</i>	130
2.2	REPARATUR DER HYDRAULIK.....	130
2.2.1	<i>Ausbau des Kopfs - Ventilgruppen</i>	130
2.2.2	<i>Einbau des Kopfs - Ventilgruppen</i>	132
2.2.3	<i>Ausbau der Kolbengruppe - Lager - Dichtungen</i>	136
2.2.4	<i>Einbau der Kolbengruppe - Lager - Dichtungen</i>	138
2.2.5	<i>Wiederherstellung des Kopfs</i>	142
3	EICHWERTE FÜR DEN SCHRAUBENANZUG	144
4	REPARATURWERKZEUGE	144
5	AUSTAUSCH DER PLEUOLAUGENBUCHSE	145
6	SPEZIALVERSIONEN	146
6.1	AUSBAU DER KOLBENGRUPPE - LAHER - DICHTUNGEN	146
6.2	EINBAU DER KOLBENGRUPPE - LAGER - DICHTUNGEN.....	148

1 EINLEITUNG

Diese Anleitung enthält die Anweisungen für die Reparatur der Pumpen der Baureihe MK und muss vor jeglichen Arbeiten an der Pumpe sorgfältig gelesen und verstanden werden. Der einwandfreie Betrieb und die lange Lebensdauer der Pumpe sind von der korrekten Verwendung und den angemessenen Wartungseingriffen abhängig. Interpump Group haftet nicht für Schäden durch Nachlässigkeit oder Nichtbeachtung der in dieser Anleitung beschriebenen Vorschriften.

1.1 BESCHREIBUNG DER SYMBOLE

Lesen Sie vor jeder Arbeit stets aufmerksam die Anweisungen in dieser Anleitung.



Warnzeichen



Lesen Sie vor jeder Arbeit stets aufmerksam die Anweisungen in dieser Anleitung.



Gefahrenzeichen
Schutzbrille tragen.



Gefahrenzeichen
Vor jeder Arbeit Schutzhandschuhe anziehen.

2 REPARATURVORSCHRIFTEN



2.1 REPARATUR DER MECHANIK

Vor den Reparaturarbeiten an der Mechanik muss zunächst das Öl aus dem Kurbelgehäuse abgelassen werden. Zum Ablassen des Öls den Öleinfüllverschluss Pos. ①, Abb. 1 und anschließend den Ölablassverschluss abnehmen, Pos. ②, Abb. 1.



Abb. 1



Altöl muss in einem geeigneten Behälter gesammelt und den entsprechenden Wertstoffstellen zugeführt werden. Es darf auf keinen Fall in die Umwelt abgeleitet werden.

2.1.1 Ausbau der Mechanik

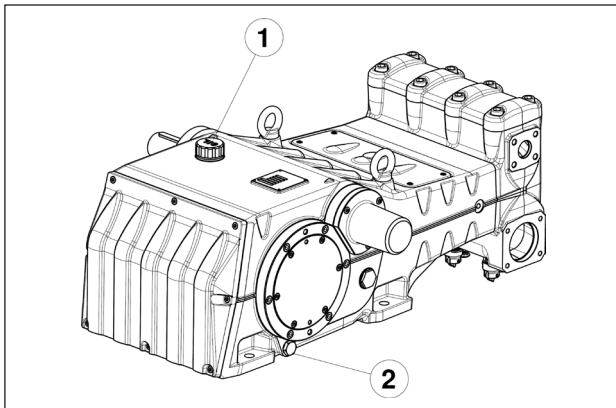
Die vorgeschriebene Arbeitsabfolge lautet:
Lassen Sie die Ölfüllung der Pumpe vollständig ab und entfernen Sie die Passfeder von der Welle (Pos. ①, Abb. 2).



Abb. 2

Lösen Sie die Befestigungsschrauben des Getriebeflanschs (Pos. ①, Abb. 3) und ziehen Sie den Flansch von der Welle ab.



Abb. 3

Lösen Sie auf der gegenüberliegenden Seite die Befestigungsschrauben des Lagerdeckels (Pos. ①, Abb. 4) und entfernen Sie den Deckel.

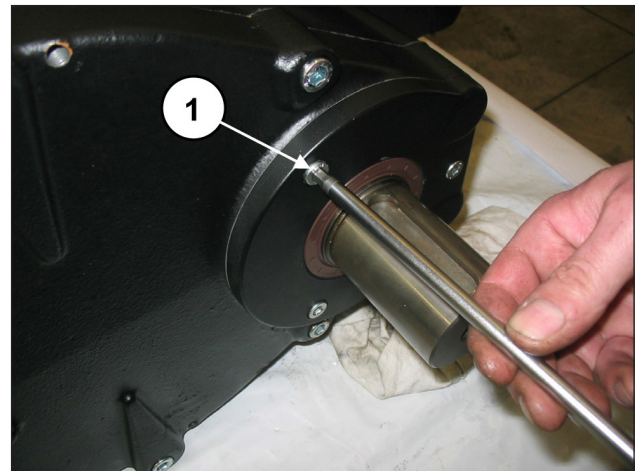

Abb. 4

Demontieren Sie den Gehäusedeckel und lösen hierzu die entsprechenden Schrauben (Pos. ①, Abb. 5).

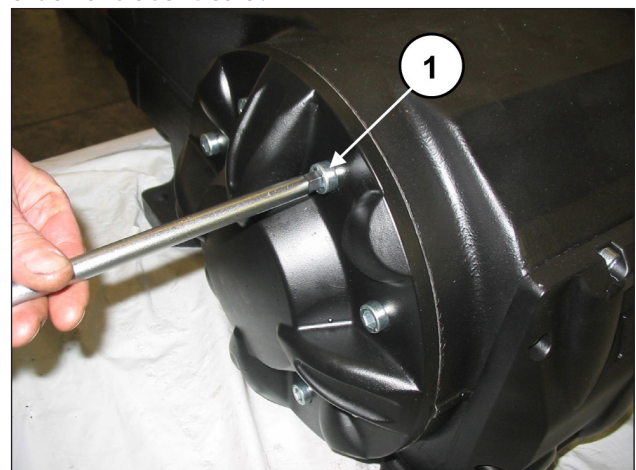

Abb. 5

Lösen Sie die Befestigungsschrauben des Getriebedeckels (Pos. ①, Abb. 6).

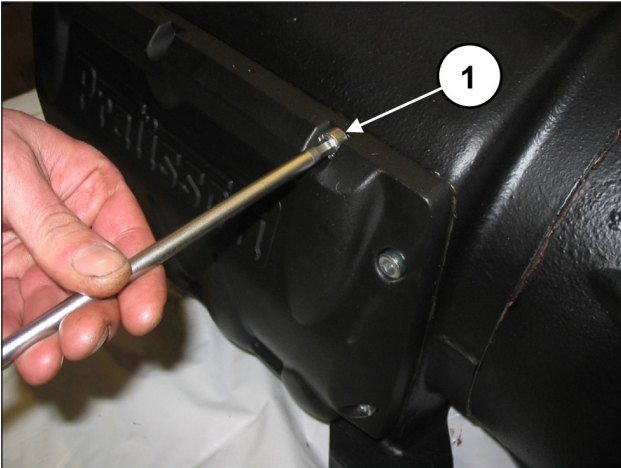

Abb. 6

Drehen Sie 3 Stiftschrauben oder Gewindeschrauben M8 (Pos. ①, Abb. 7) als Abzieher in die entsprechenden Bohrungen ein und zwei ausreichend lange Schrauben M10 für die Halterung des Deckels ein (Pos. ②, Abb. 7).

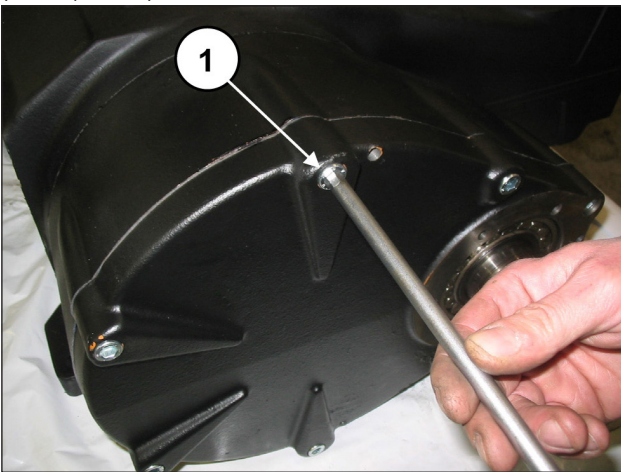

Abb. 7

Drehen Sie die 3 Stiftschrauben (Pos. ①, Abb. 8) als Abzieher ein und schlagen Sie gleichzeitig mit dem Werkzeug (Art. 27516700) auf den Deckel, damit sich das Lager beim Abnehmen des Deckels nicht vom Ritzel löst (Pos. ①, Abb. 9).



Abb. 8

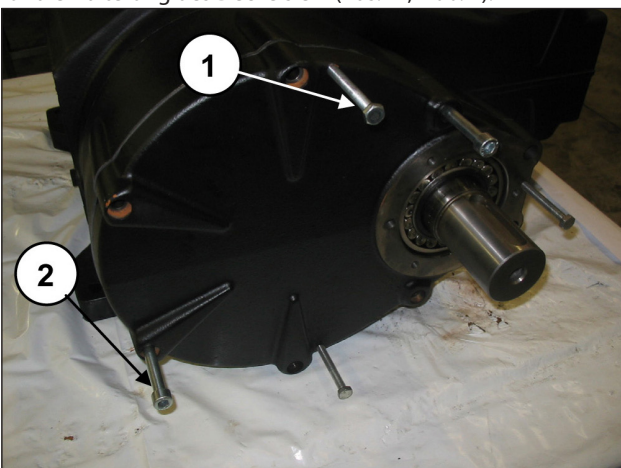

Abb. 9

Entfernen Sie anschließend den Getriebedeckel und ziehen Sie dann das Lager vom Ritzel ab.

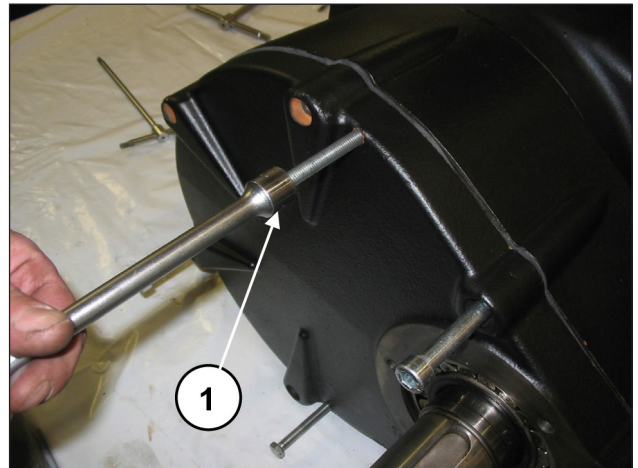
Lösen Sie die Befestigungsschrauben des Zahnkranzhalters (Pos. ①, Abb. 10) und entfernen Sie den Halter (Pos. ①, Abb. 11).

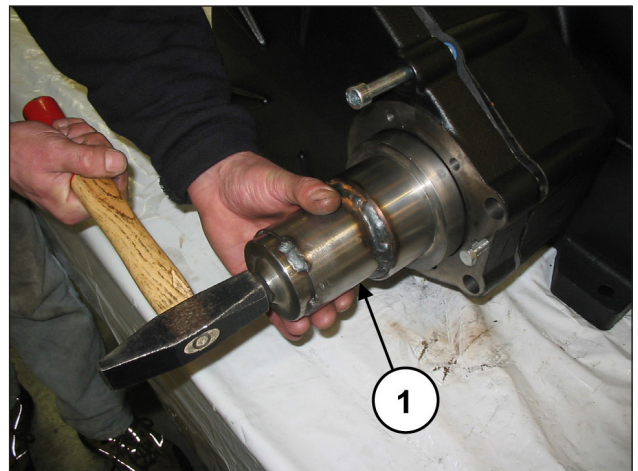

Abb. 10



Abb. 11

Entfernen Sie den Zahnkranz (Pos. ①, Abb. 12). Bei Bedarf können Sie einen Abzieher mit Schlagwerk an den 2 Bohrungen M8 ansetzen (Pos. ②, Abb. 12).

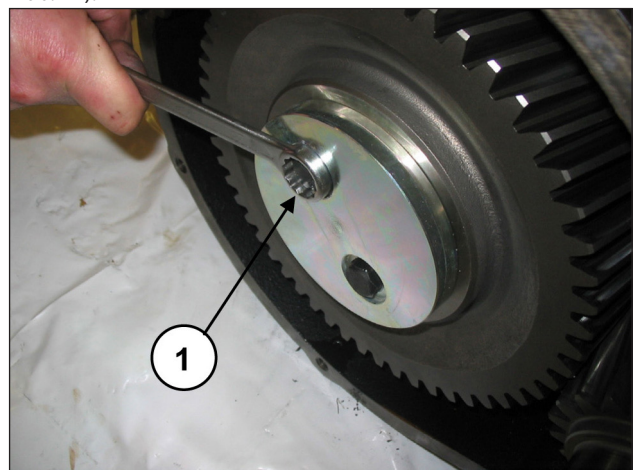

Abb. 12

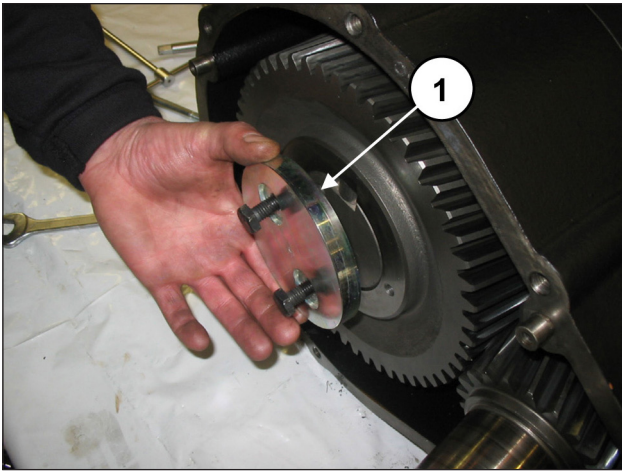
Nehmen Sie die Passfeder von der Welle ab (Pos. ①, Abb. 13).

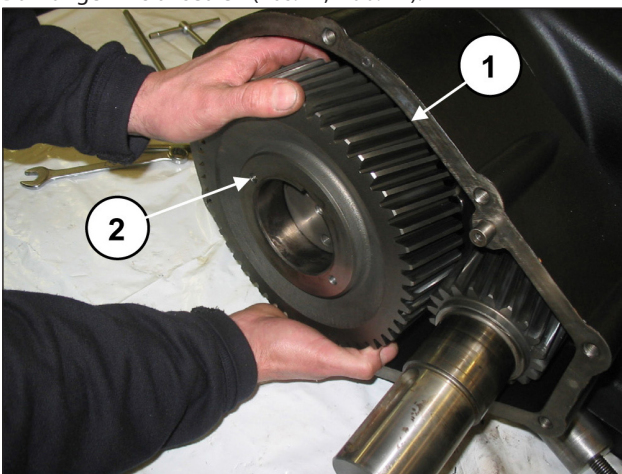

Abb. 13

Nehmen Sie das Ritzel mithilfe eines Abziehers mit Schlagwerk an Bohrung M14 ab (Pos. ①, Abb. 14).

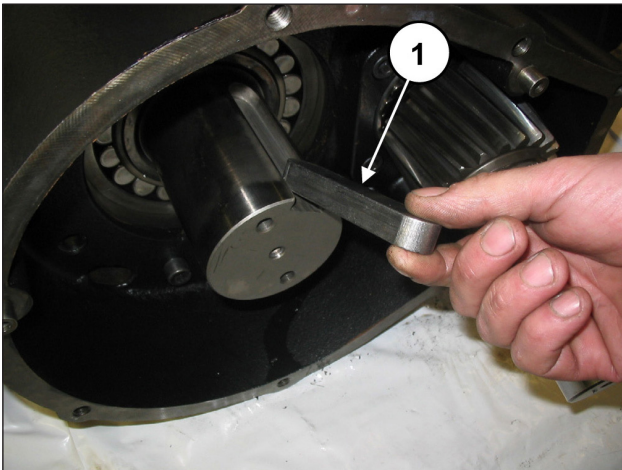

Abb. 14

Heben Sie die Sicherungsscheibe (Pos. ①, Abb. 15).

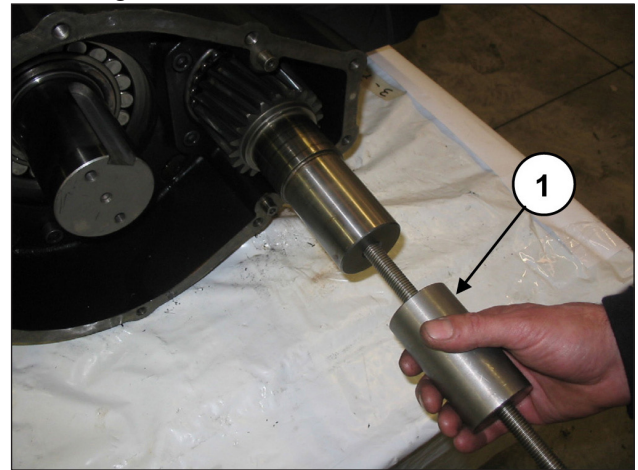

Abb. 15

Setzen Sie eine Passscheibe unter die Pleuelstange, um die Wellendrehung zu kontern (Pos. ①, Abb. 16).

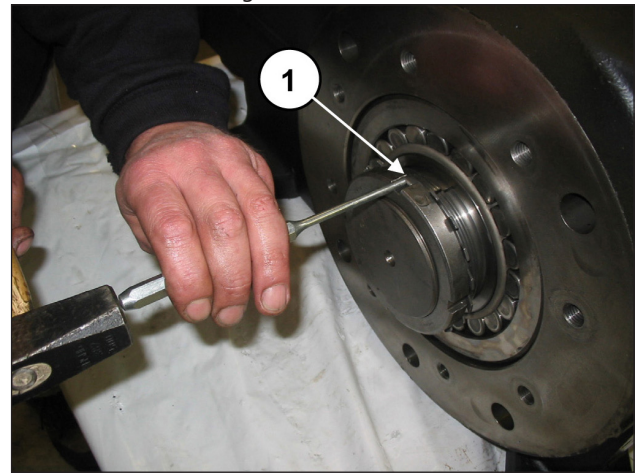

Abb. 16

Lösen Sie mit einem geeigneten Schlüssel die Nutmutter (Pos. ①, Abb. 17) und entfernen Sie dann Nutmutter sowie Sicherungsscheibe (Pos. ①, Abb. 18).



Abb. 17

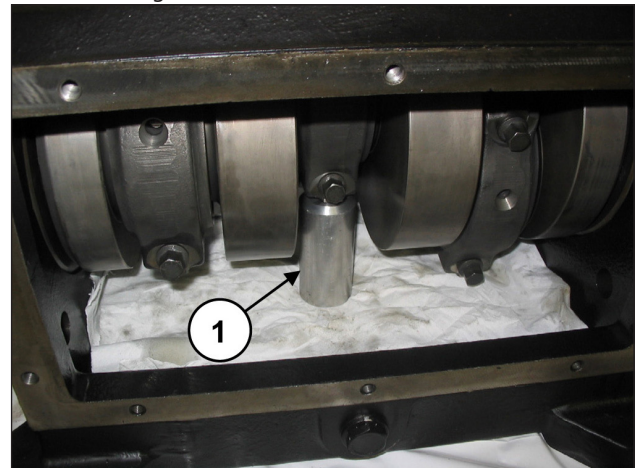

Abb. 18

Drehen Sie eine Nutmutter Typ SKF KM19 auf die Druckbuchse (Pos. ①, Abb. 19), und lockern Sie dann mit einem entsprechenden Schlüssel die Buchse (Pos. ①, Abb. 20).

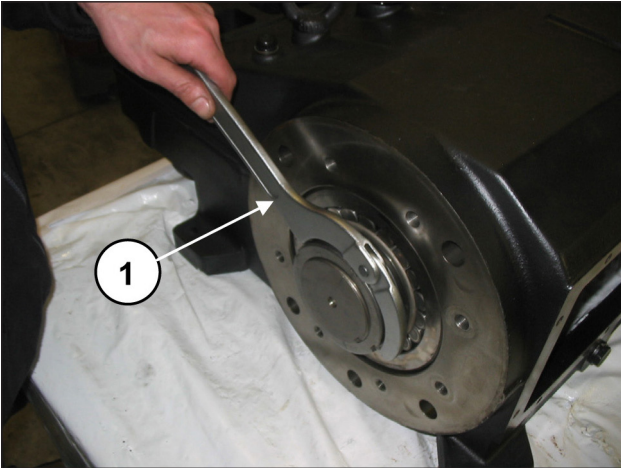

Abb. 19

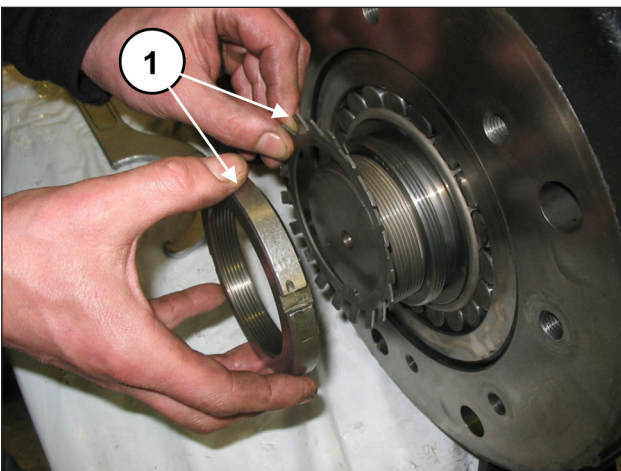

Abb. 20

Lösen Sie an der entgegengesetzte Seite die Befestigungsschrauben des Getriebegehäuses (Pos. ①, Abb. 21) und entfernen Sie das Gehäuse (Pos. ①, Abb. 22).

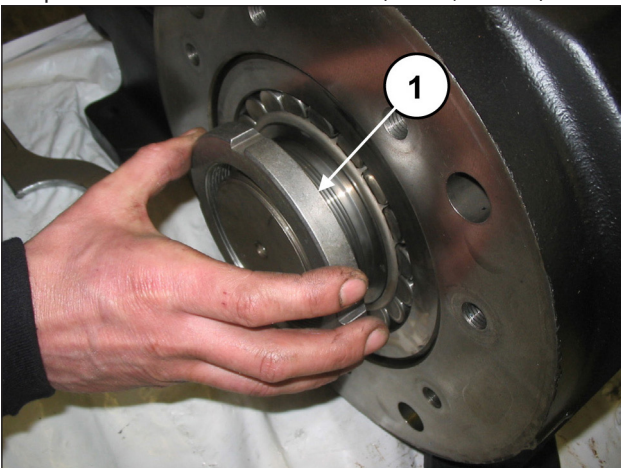

Abb. 21

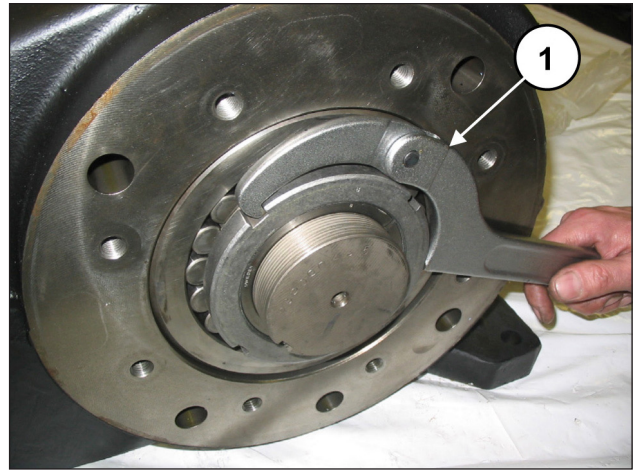

Abb. 22

Lösen Sie die Schrauben der Pleuelstange (Pos. ①, Abb. 23).

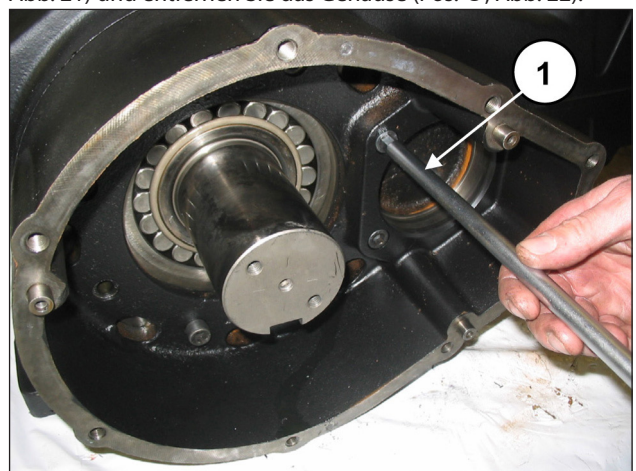

Abb. 23

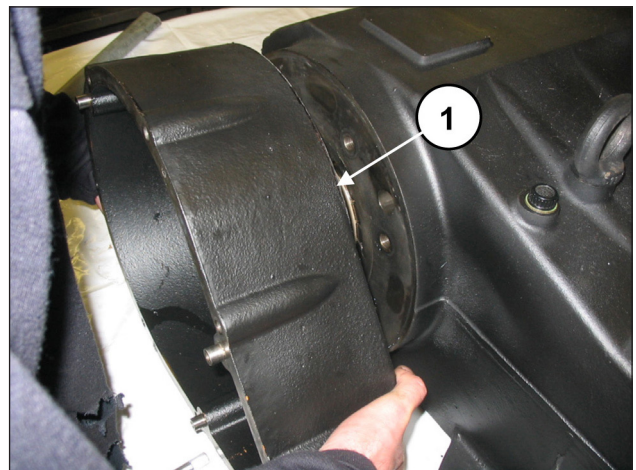
Demontieren Sie die Pleueldeckel samt Lagerschalen und achten Sie dabei genau auf die Ausbaureihenfolge.

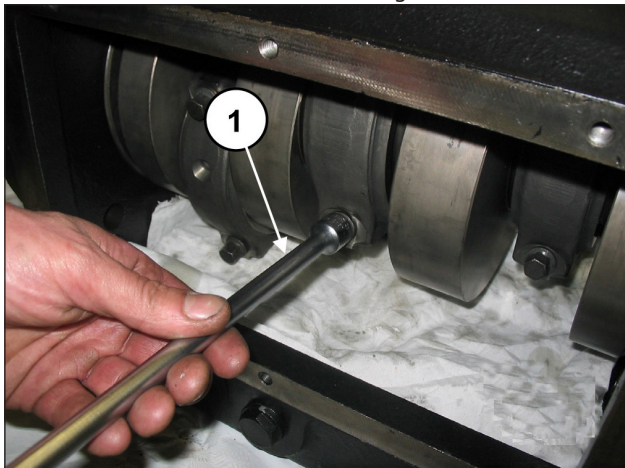

Pleueldeckel und Pleuelhälften müssen in der gleichen Paarungs- und Ausbaureihenfolge wieder eingebaut werden.

Um Fehler zu vermeiden, sind Pleueldeckel und Pleuelhälften auf einer Seite nummeriert (Pos. ①, Abb. 24).



Abb. 24

Schieben Sie die Pleuelhälften in Richtung Hydraulik ganz vor, damit die Kurbelwelle heraustreten kann. Verwenden Sie als Arbeitshilfe das entsprechende Werkzeug (Art. 27566200), (Pos. ①, Abb. 25).

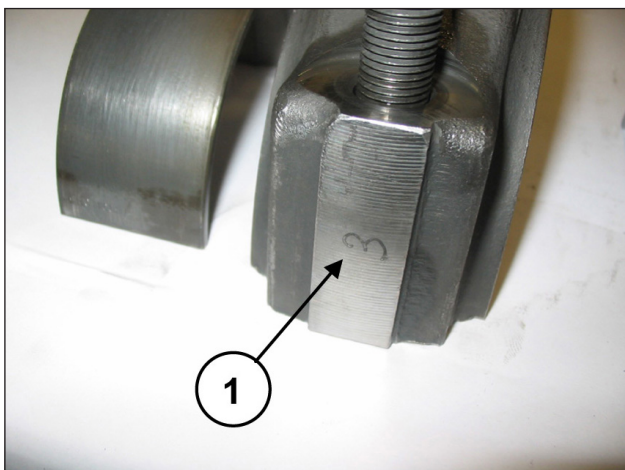

Abb. 25

Nehmen Sie die Druckbuchse ab (Pos. ①, Abb. 26).

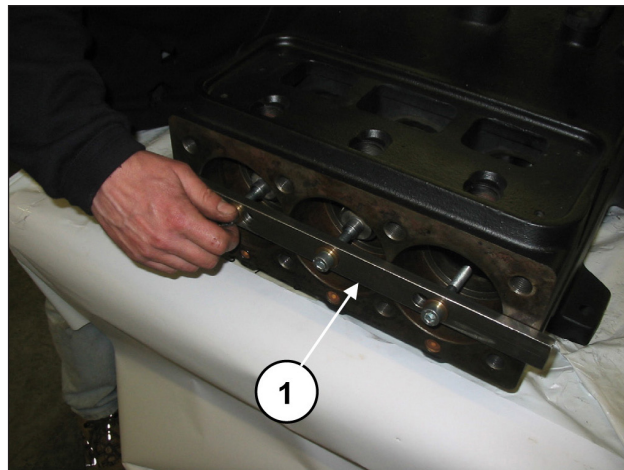

Abb. 26

Ziehen Sie die drei Lagerschalen der Pleuelhälften ab (Pos. ①, Abb. 27).

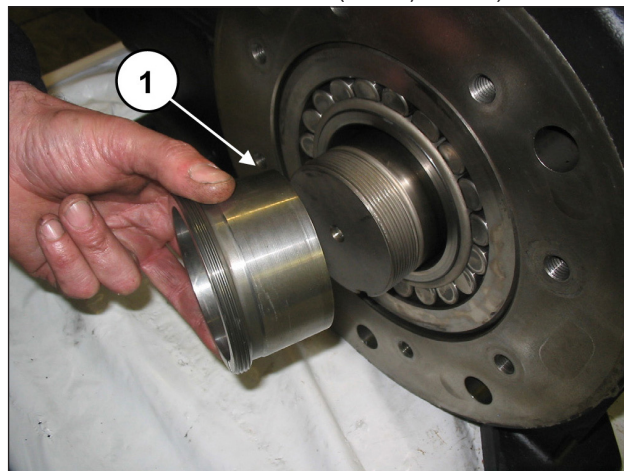

Abb. 27

Treiben Sie die Kurbelwelle mithilfe eines Schlagwerks auf Zapfwellenseite heraus (Pos. ①, Abb. 28).
Entfernen Sie Welle und Lager (Pos. ①, Abb. 29).



Abb. 28

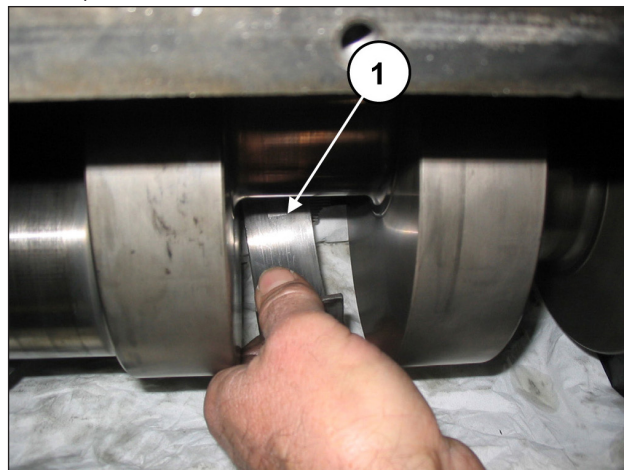

Abb. 29

Entnehmen Sie an der gegenüberliegenden Seite das Lager (Pos. ①, Abb. 30).

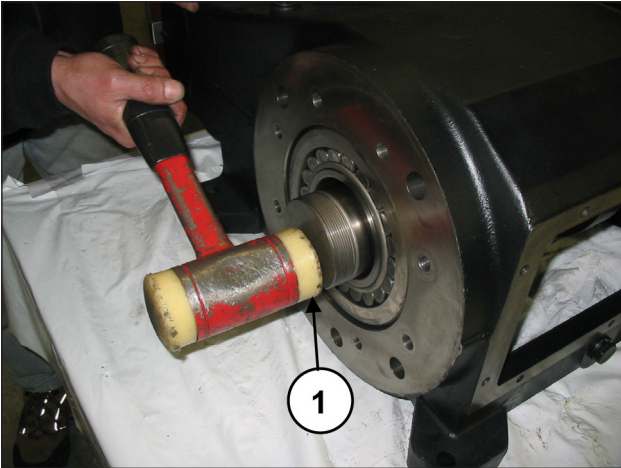

Abb. 30

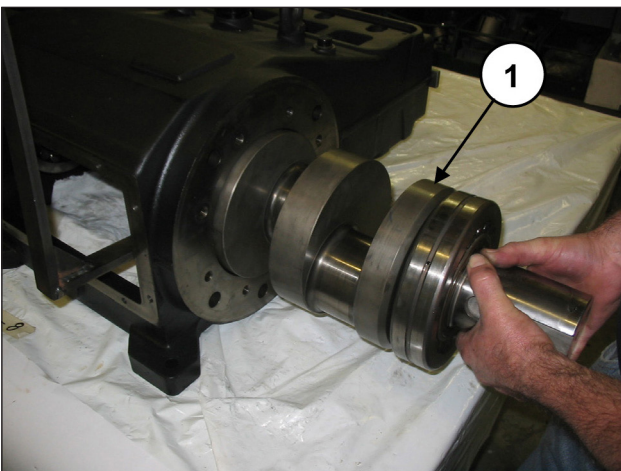
Gehen Sie für den etwaigen Austausch einer oder mehrerer Pleuelstangen oder Kolbenführungen wie folgt vor:

Drehen Sie die Schrauben des Werkzeugs Art. 27566200 zum Lösen der Pleuelstangen ab (Pos. ①, Abb. 31) und ziehen Sie anschließend die Baugruppe Pleuelstange-Kolbenführung von der hinteren Gehäuseöffnung heraus (Pos. ①, Abb. 32).

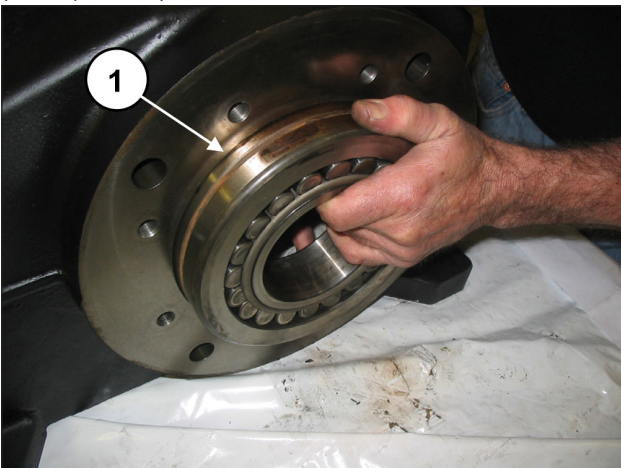

Abb. 31



Abb. 32

Paaren Sie die Pleuelhälften mit dem vorab ausgebauten Pleueldeckeln unter Berücksichtigung der Nummerierung (Pos. ①, Abb. 33).

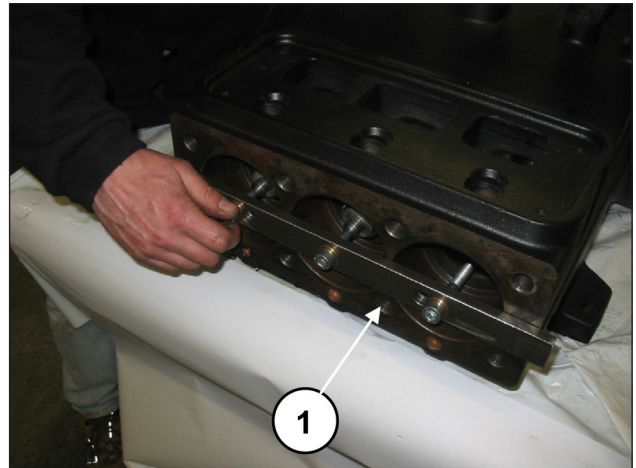

Abb. 33

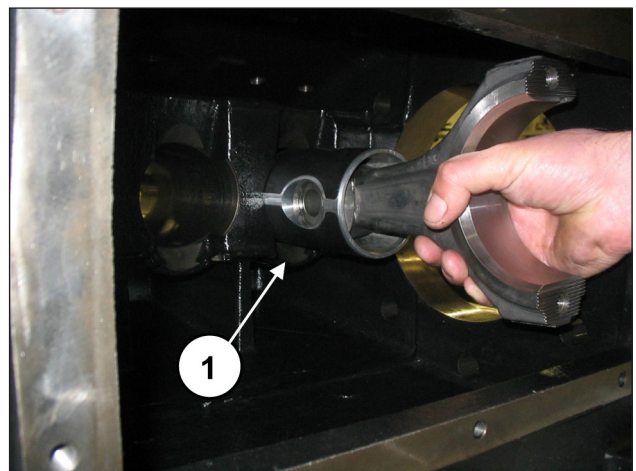
Entfernen Sie die zwei Seegerringe zur Sicherung des Bolzens mit einem geeigneten Werkzeug (Pos. ①, Abb. 34).

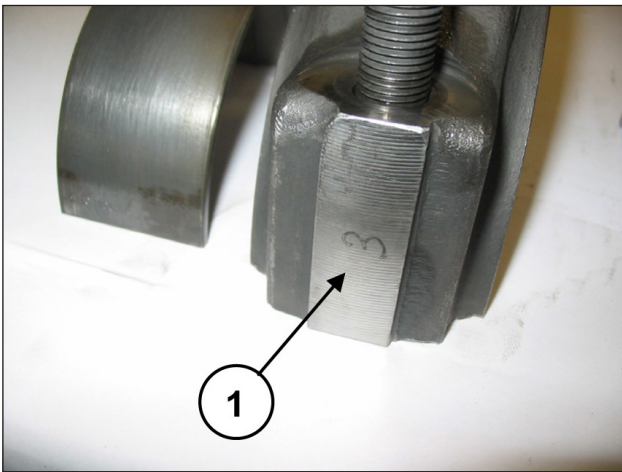

Abb. 34

Streifen Sie den Bolzen ab (Pos. ①, Abb. 35) und ziehen Sie die Pleuelstange heraus (Pos. ①, Abb. 36).



Abb. 35

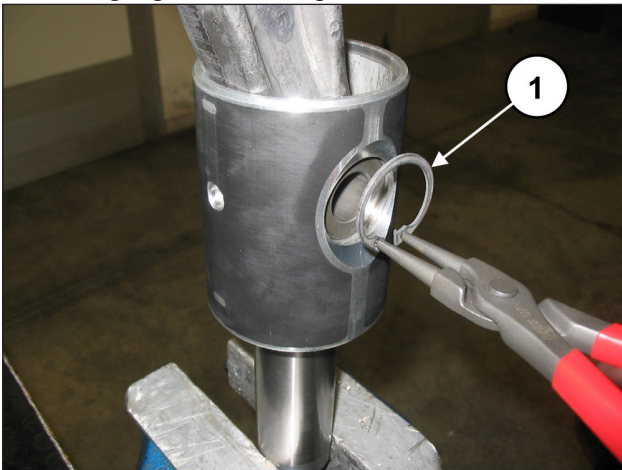

Abb. 36

Drehen Sie zum Trennen der Stange von der Kolbenführung die Zylinderkopfschrauben M6 mit dem entsprechenden Schlüssel ab (Pos. ①, Abb. 37).

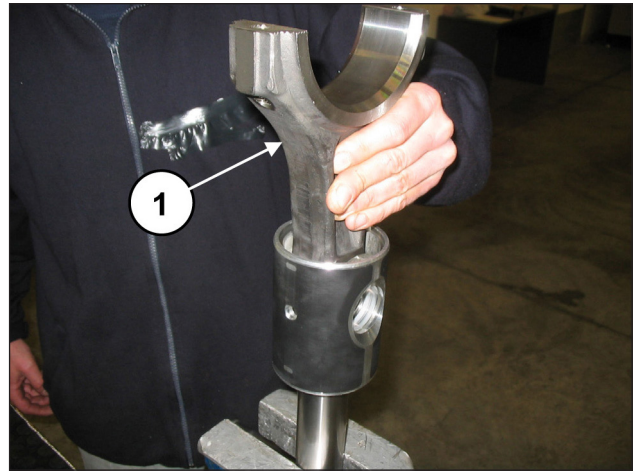

Abb. 37

2.1.2 Einbau der Mechanik

Verfahren Sie für den Einbau in umgekehrter Reihenfolge zu den Angaben in Abschn. 2.1.1.

Die vorgeschriebene Arbeitsabfolge lautet:

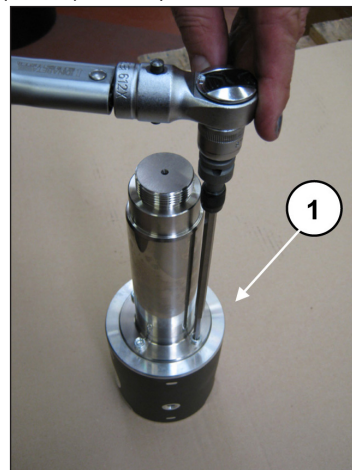
Montieren Sie die Stange an die Kolbenführung.

Setzen Sie die Kolbenführungsstange in die entsprechende Aufnahme an der Kolbenführung ein (Pos. ①, Abb. 38) und befestigen Sie die Stange mit den 4 Zylinderkopfschrauben M6x20 (Pos. ①, Abb. 39).



Abb. 38



Abb. 39

Spannen Sie die Kolbenführung mithilfe des speziellen Werkzeugs in einen Schraubstock und eichen Sie die Schrauben mit einem Drehmomentschlüssel (Pos. ①, Abb. 40) gemäß Angaben in Kapitel 3.

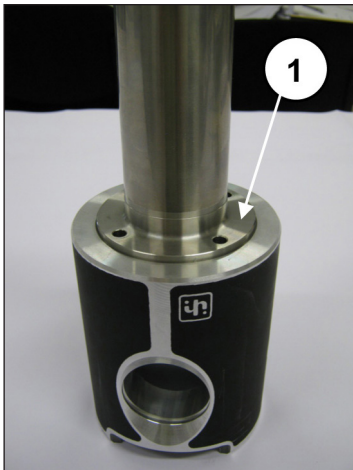

Abb. 40

Setzen Sie die Pleuelstange in die Kolbenführung ein (Pos. ①, Abb. 36) und anschließend den Bolzen (Pos. ①, Abb. 35). Montieren Sie die zwei Seegerringe zur Sicherung mit dem entsprechenden Werkzeug (Pos. ①, Abb. 34).

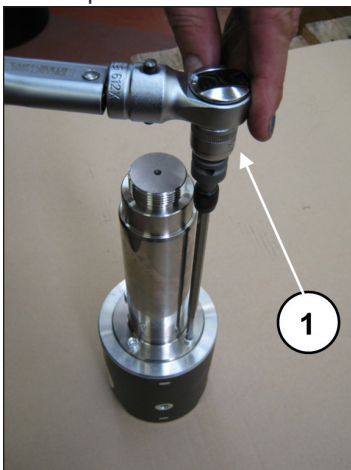

Der Einbau ist korrekt, wenn Pleuelauge, Kolbenführung und Bolzen freigängig drehen.

Trennen Sie Pleueldeckel und Pleuelhälften; die vorschriftsmäßige Paarung wird durch die seitliche Nummerierung garantiert (Pos. ①, Abb. 33).

Nachdem Sie das Gehäuse auf perfekte Sauberkeit überprüft haben, setzen Sie die Baugruppe Pleuelhälfte-Kolbenführung in die Buchsen des Gehäuses ein (Pos. ①, Abb. 32).



Beim Einsetzen der Baugruppe Pleuelhälfte-Kolbenführung in das Gehäuse müssen die Pleuelhälften mit nach oben sichtbarer Nummerierung ausgerichtet werden.

Arretieren Sie die drei Baugruppen mit dem entsprechenden Werkzeug Art. 27566200 (Pos. ①, Abb. 31).

Montieren Sie das Lager auf Zapfwellenseite vorläufig und bündig auf die Welle (Pos. ①, Abb. 41) und setzen Sie das Lager an der entgegengesetzten Seite in das Gehäuse ein (Pos. ①, Abb. 42).



Das Lager in Abb. 42 verfügt über einen konischen Innenring. Vergewissern Sie sich vor Einsetzen der Buchse, dass die Konizität von außen nach innen verläuft.



Abb. 41



Abb. 42

Setzen Sie die Welle ein (Pos. ①, Abb. 29) bis das vormontierte Lager bündig zur Kante des Gehäuses ausgerichtet ist (Pos. ①, Abb. 43).

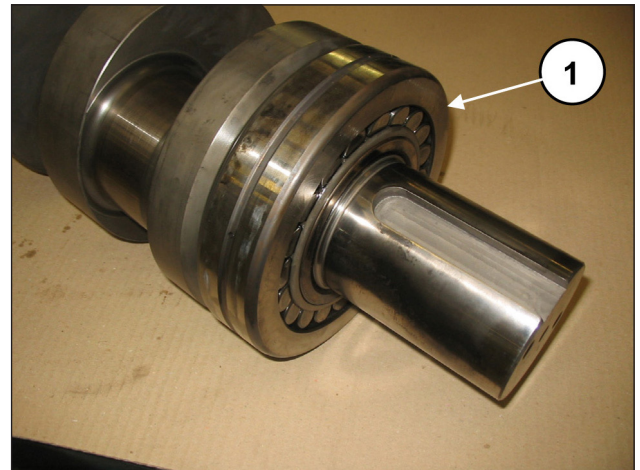

Abb. 43

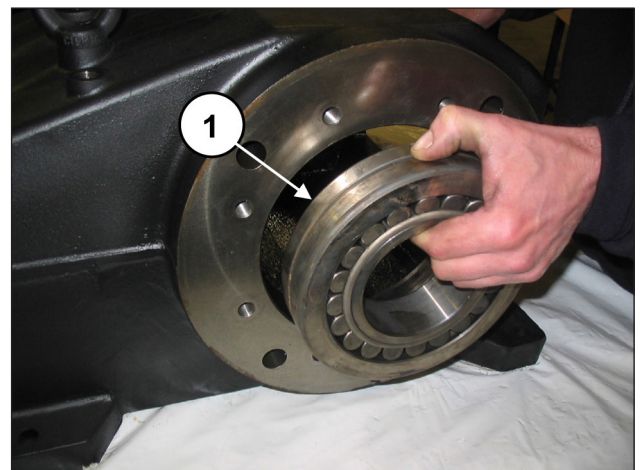
Setzen Sie Druckbuchse von Hand ein, um die Ausrichtung der Welle zu gewährleisten (Pos. ①, Abb. 44).

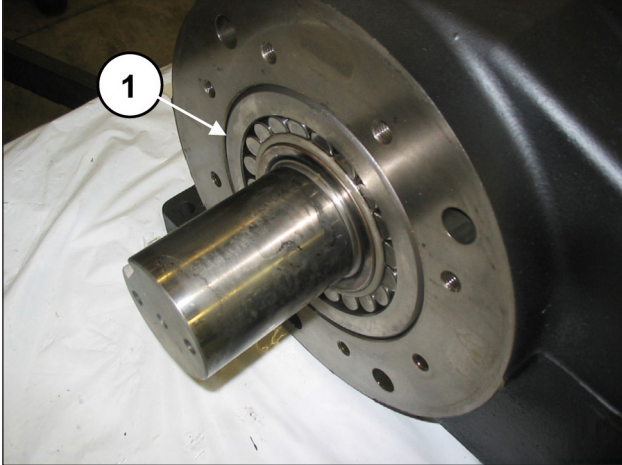

Abb. 44

Montieren Sie das Getriebegehäuse (Pos. ①, Abb. 45) und die entsprechende Dichtung ein (Pos. ②, Abb. 45) mit den 6 Schrauben M12x40 (Pos. ①, Abb. 46), den 2 Schrauben M12x50 (Pos. ①, Abb. 47) und den Federscheiben Ø12 (Pos. ②, Abb. 46 und Abb. 47).

Eichen Sie die Schrauben mit einem Drehmomentschlüssel (Pos. ①, Abb. 48) gemäß Angaben in Kapitel 3.

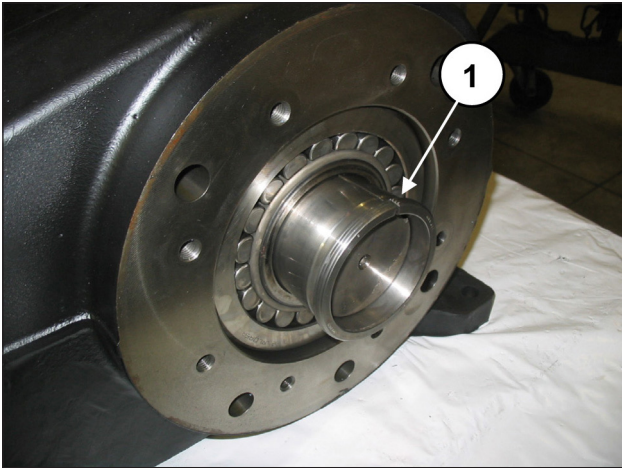

Abb. 45



Abb. 46

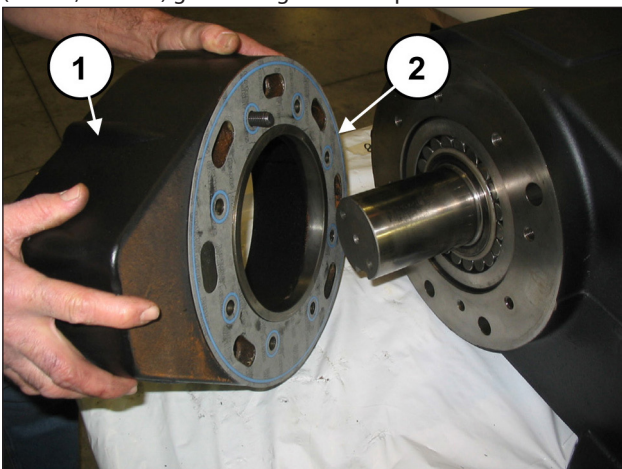

Abb. 47

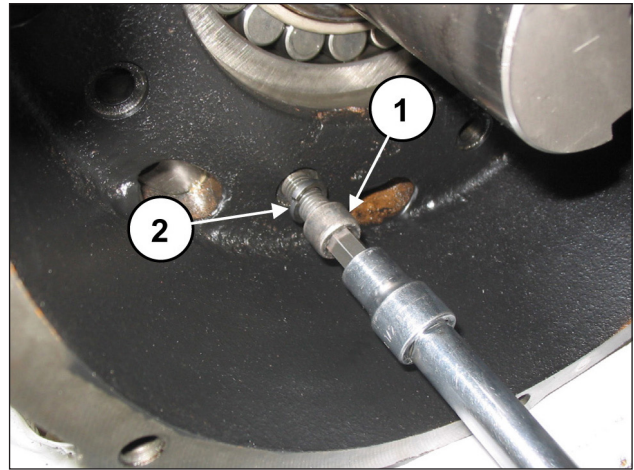

Abb. 48

Schieben Sie die Druckbuchse vollständig von der zur Zapfwelle entgegengesetzten Seite auf die Welle (Pos. ①, Abb. 49 und Abb. 50).

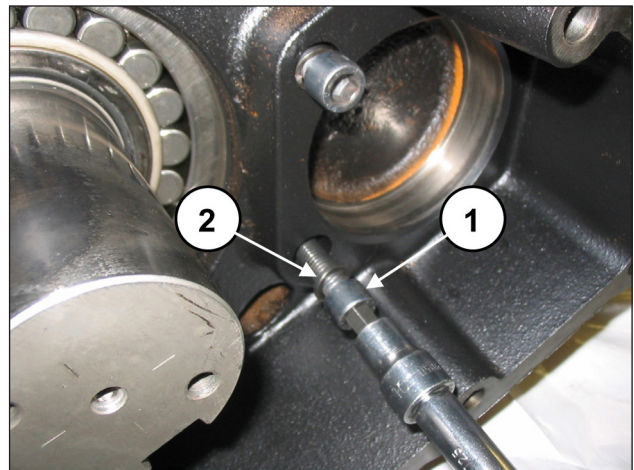

Abb. 49

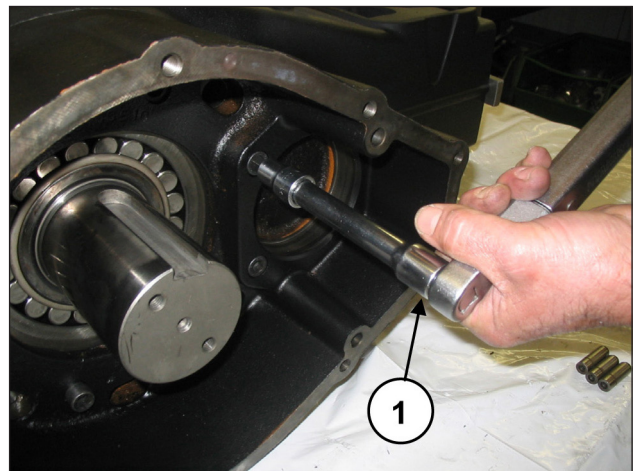

Abb. 50



Setzen Sie die Druckbuchse trocken (ohne Öl oder Schmierstoff ein).

Setzen Sie die Buchse soweit ein, bis sich die Außenfläche (konisch) perfekt mit der Innenseite des Lagers verbindet. Achten Sie beim Einsetzen darauf, dass das Lager mit dem Wellenbund in Kontakt bleibt.

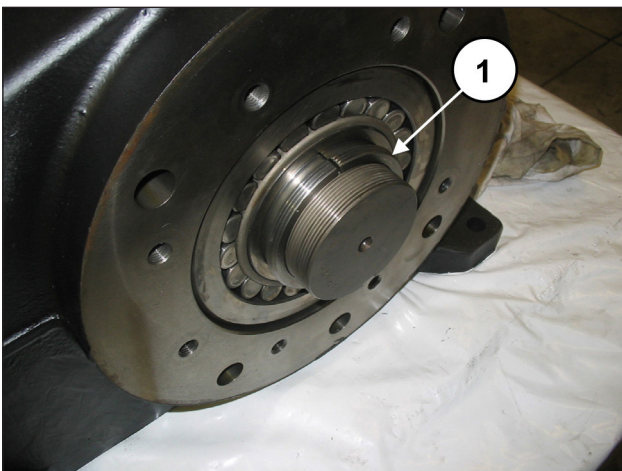
Messen Sie das Maß "X" in Abb. 51.



Abb. 51

Drehen Sie die Nutmutter fest und sichern Sie die Buchse, bis eine Reduzierung des Maßes "X" zwischen 0,7 und 0,8 mm eintritt (Abb. 52).

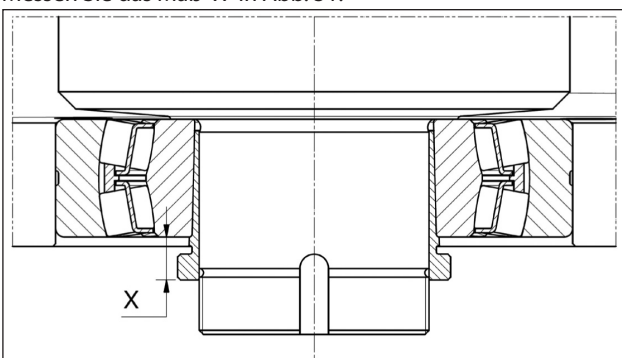

Abb. 52

Lösen Sie die Nutmutter, setzen Sie die Sicherungsscheibe ein (Pos. ①, Abb. 53) und drehen Sie dann die Nutmutter wieder fest (Pos. ①, Abb. 54), biegen Sie daraufhin die Sperrlasche der Scheibe um (Pos. ①, Abb. 55).



Abb. 53

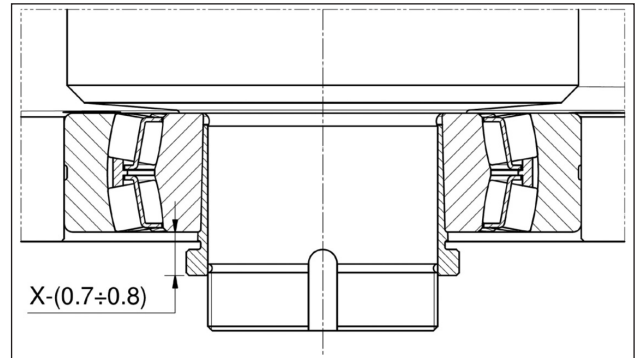

Abb. 54

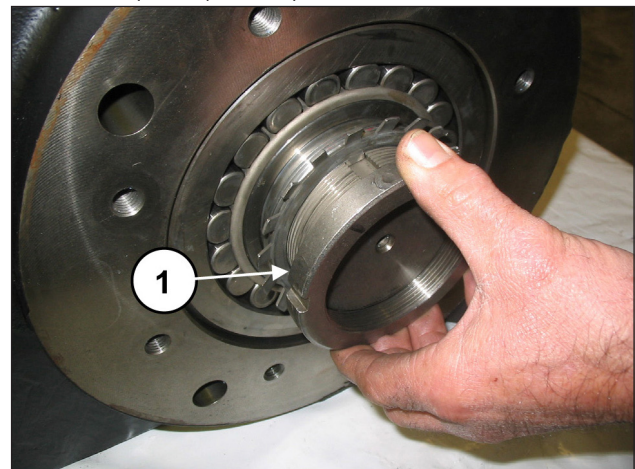

Abb. 55

Entfernen Sie das Werkzeug zur Sicherung der Pleuelstangen Art. 27566200 (Pos. ①, Abb. 31).

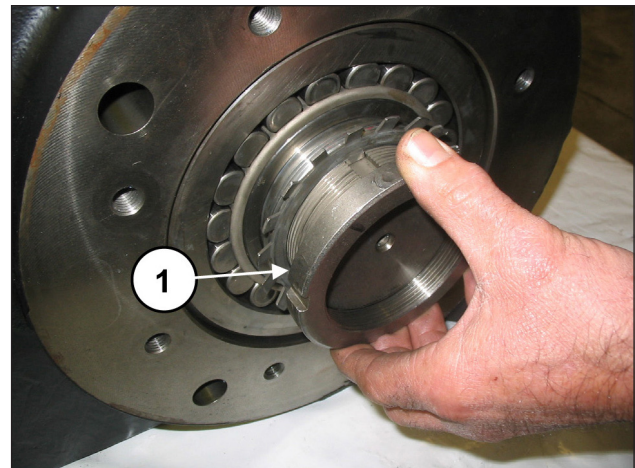
Setzen Sie die oberen Lagerschalen zwischen Pleuelstange und Welle ein (Pos. ①, Abb. 56).

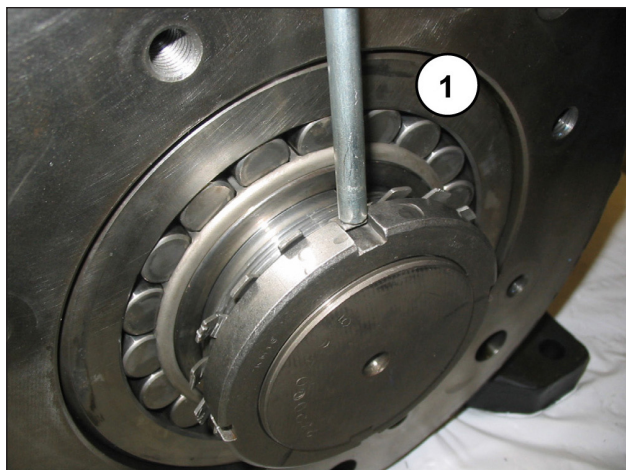

Stellen Sie für einen vorschriftsmäßigen Einbau der Lagerschalen sicher, dass die Bezugsmarkierung der Lagerschalen in der entsprechenden Aufnahme an der Pleuelhälfte zu liegen kommt (Pos. ①, Abb. 57).



Abb. 56



Abb. 57

Montieren Sie die unteren Lagerschalen an die Pleueldeckel (Pos. ①, Abb. 58) und vergewissern Sie sich dabei, dass die Bezugsmarkierung der Lagerschalen in der entsprechenden Aufnahme am Deckel zu liegen kommt (Pos. ②, Abb. 58). Befestigen Sie die Pleueldeckel mit Pleuelhälften anhand der Schrauben M12x1.25x87 (Pos. ①, Abb. 59).

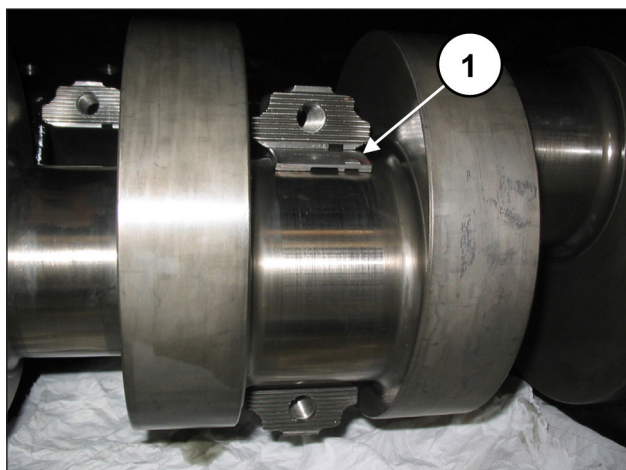

Achten Sie auf den richtigen Einbausinn der Lagerdeckel. Die Nummerierung muss nach oben gerichtet sein.

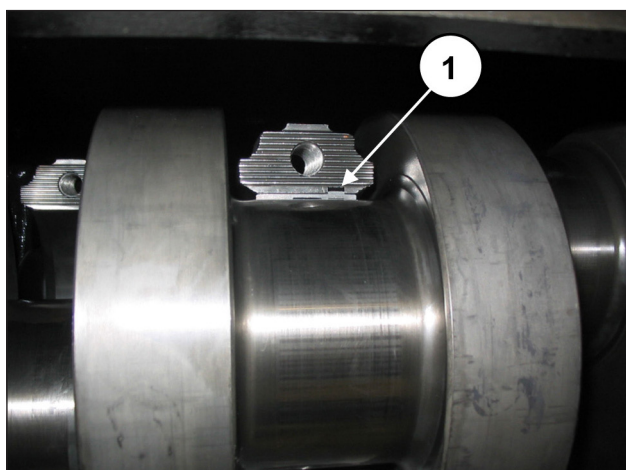
Eichen Sie die Schrauben mit einem Drehmomentschlüssel, wie in Kapitel 3 gezeigt, und ziehen Sie gleichzeitig die Schrauben auf Anzugsmoment fest.



Abb. 58



Abb. 59

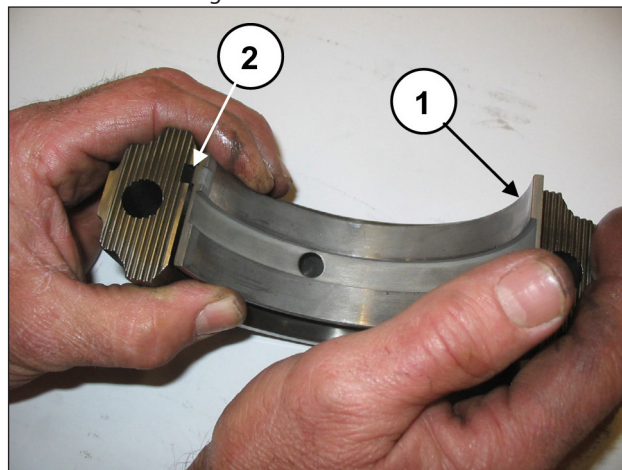

Überprüfen Sie nach abgeschlossenem Vorgang, ob die Pleuelstangen in beiden Richtungen Axialspiel aufweisen.

Montieren Sie das Lager vorläufig auf das Ritzel (Pos. ①, Abb. 60) und setzen Sie das Ritzel bündig in seine Aufnahme am Getriebegehäuse ein (Pos. ①, Abb. 61); verwenden Sie dazu ein Schlagwerk.

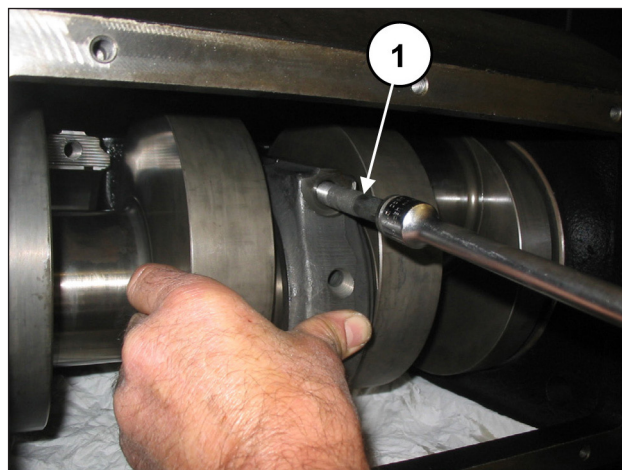

Abb. 60



Abb. 61

Montieren Sie die Passfeder 22x14x100 in den Wellensitz (Pos. ①, Abb. 62) und schieben Sie den Zahnkranz auf die Welle.

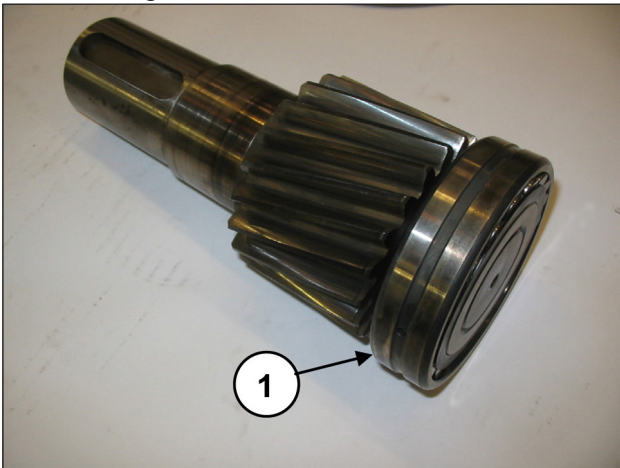
Befestigen Sie die Zahnkranzarretterung (Pos. ①, Abb. 63) mit den 2 Schrauben M10x25 (Pos. ②, Abb. 63). Eichen Sie die Schrauben mit einem Drehmomentschlüssel, wie in Kapitel 3 gezeigt.

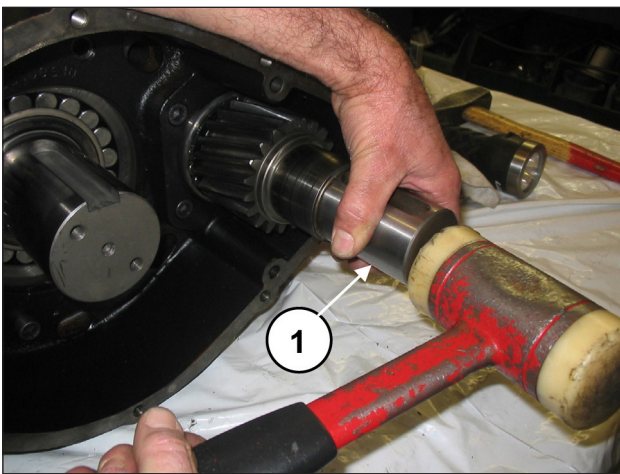

Abb. 62



Abb. 63

Bringen Sie die 3 Stifte Ø12x24 am Getriebegehäuse an (Pos. ①, Abb. 64) und setzen Sie die Dichtung ein (Pos. ①, Abb. 65).

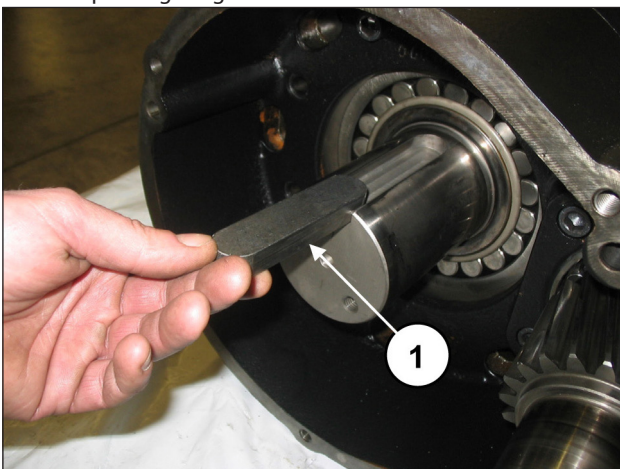

Abb. 64

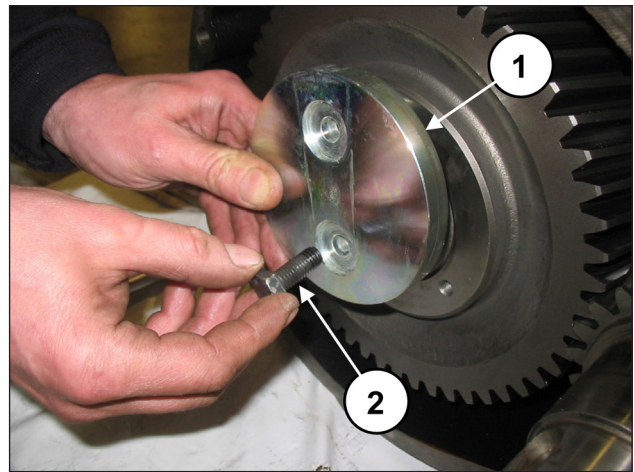

Abb. 65

Montieren Sie das Lager in den Getriebedeckel (Pos. ①, Abb. 66).

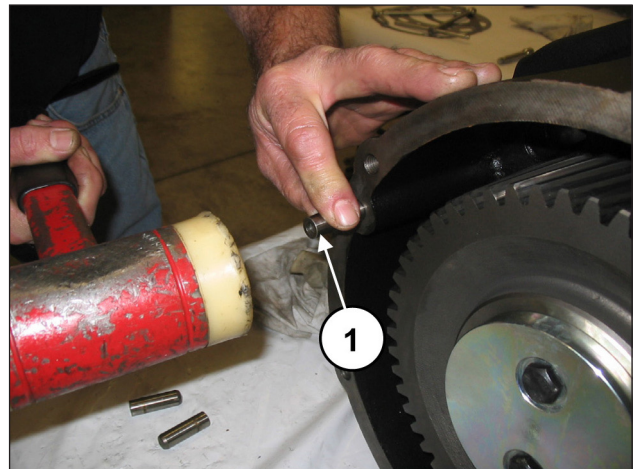

Abb. 66

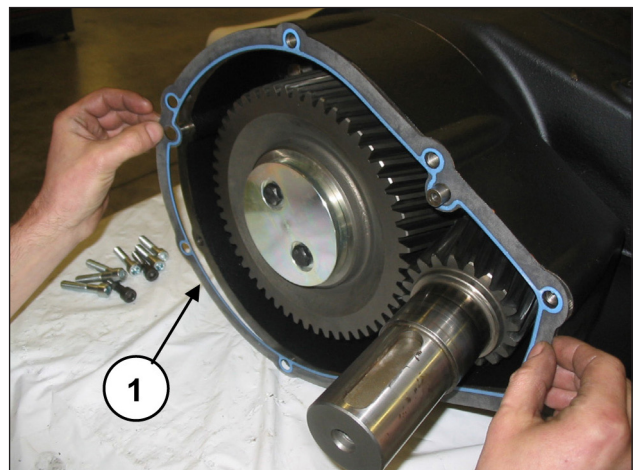
Bauen Sie den Getriebedeckel ein (Pos. ①, Abb. 67) und befestigen Sie den Deckel anhand von 8 Schrauben M10x50 (Pos. ①, Abb. 68). Unter Anwendung eines Dorns vermeiden Sie, dass das Lager aus seinem Sitz austritt (Pos. ①, Abb. 69). Eichen Sie die Schrauben mit einem Drehmomentschlüssel, wie in Kapitel 3 gezeigt.



Abb. 67

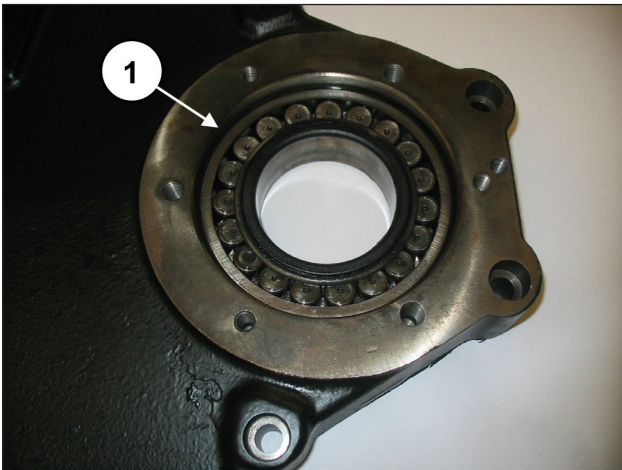

Abb. 68

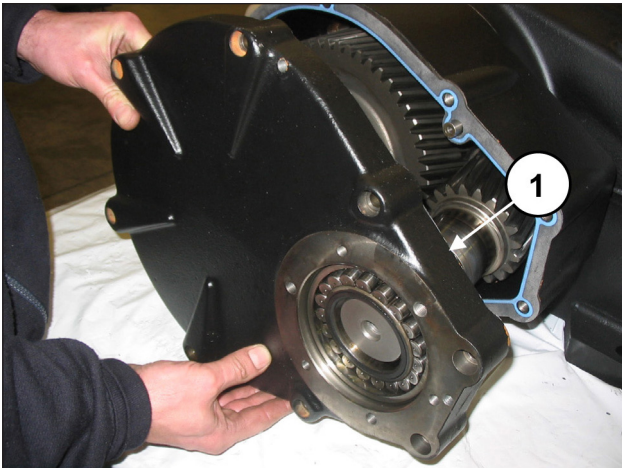

Abb. 69

Setzen Sie den Ölabbstreifring in den Getriebebeflansch ein. Verwenden Sie hierfür die Werkzeuge Art. 27515900 und 27548200 (Pos. ①, Abb. 70).

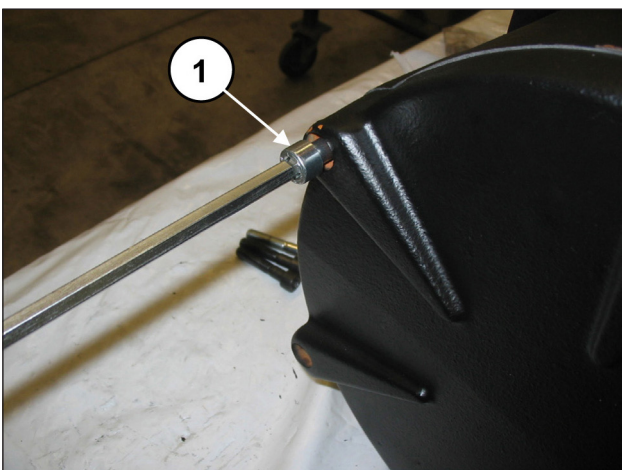
Überprüfen Sie vor Einbau des Ölabbstreifrings den Zustand der Dichtlippe. Im Fall eines Austauschs setzen Sie den neuen Ring bündig in die Nut ein, siehe Abb. 71.



Sollte die Welle im Bereich mit der Dichtlippe einen Verschleiß am Durchmesser aufweisen, können Sie zur Vermeidung der Schleifbearbeitung den Ring auf Anschlag mit dem Deckel neu ausrichten, siehe hierzu Abb. 71.



Abb. 70



Abb. 71

Montieren Sie den Getriebeflansch samt Dichtung in das Getriebegehäuse (Pos. ①, Abb. 72) und befestigen Sie den Flansch anhand von 3 Schrauben M8x18 (Pos. ①, Abb. 73).

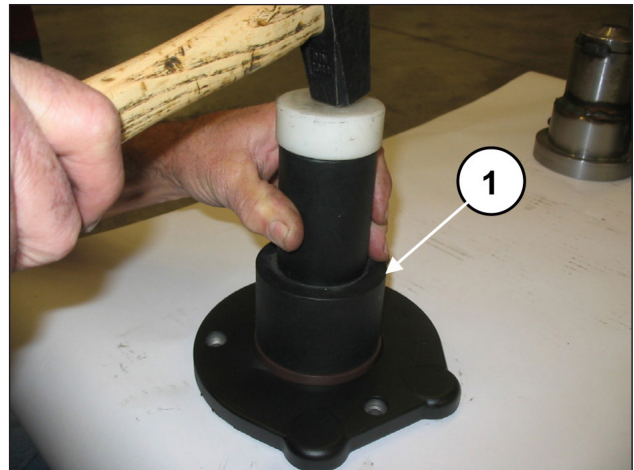

Geben Sie besonders beim Einsetzen des Flanschs auf das Ritzel acht, um den Ölabstreifring nicht zu beschädigen

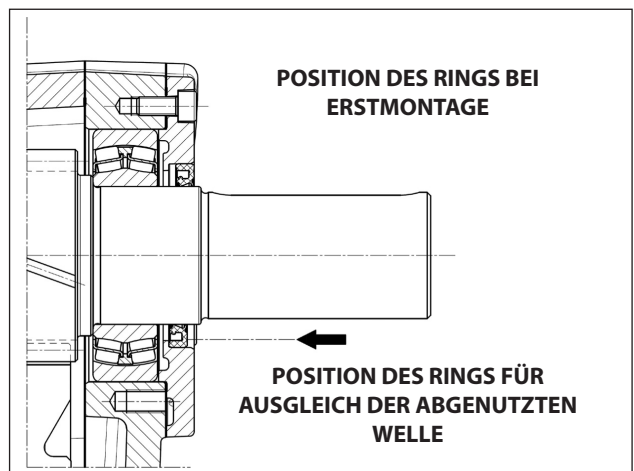
Eichen Sie die Schrauben mit einem Drehmomentschlüssel, wie in Kapitel 3 gezeigt.



Abb. 72



Abb. 73

Setzen Sie die Passfeder 16x10x90 in das Ritzel ein. Setzen Sie den O-Ring in den hinteren Deckel ein (Pos. ①, Abb. 74) und befestigen Sie den Deckel am Gehäuse anhand von 10 Schrauben M8x18 (Pos. ①, Abb. 75).

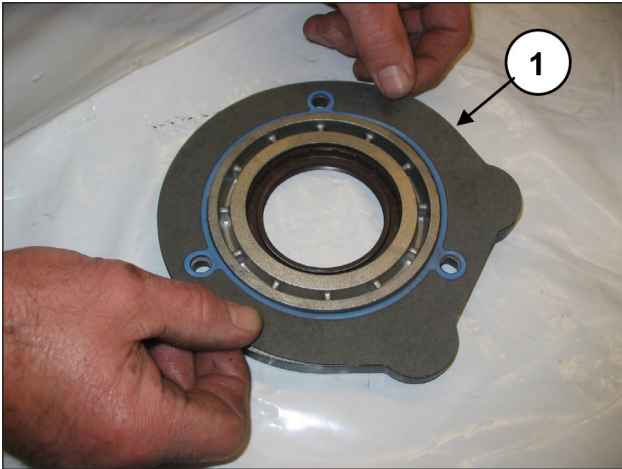
Eichen Sie die Schrauben mit einem Drehmomentschlüssel, wie in Kapitel 3 gezeigt.

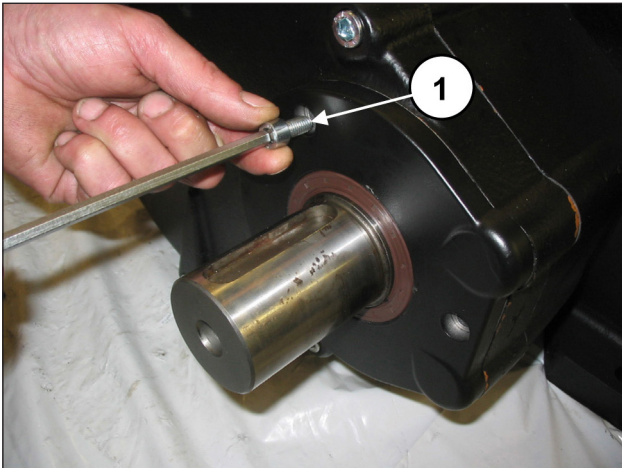

Abb. 74



Abb. 75

Montieren Sie den Lagerdeckel (samt Dichtung) (Pos. ①, Abb. 76) mit 8 Schrauben M12x30 (Pos. ①, Abb. 77). Eichen Sie die Schrauben mit einem Drehmomentschlüssel, wie in Kapitel 3 gezeigt.

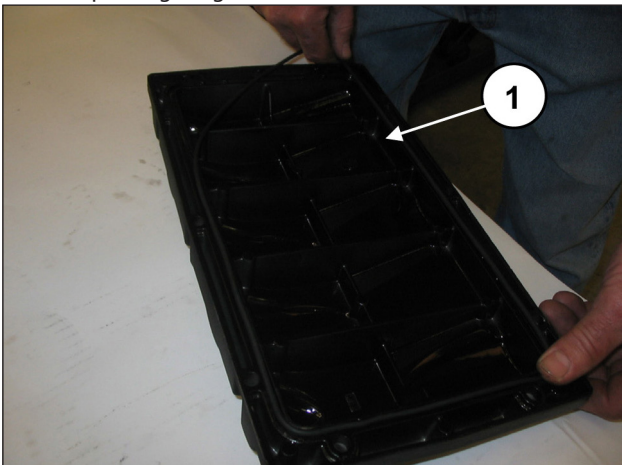

Abb. 76

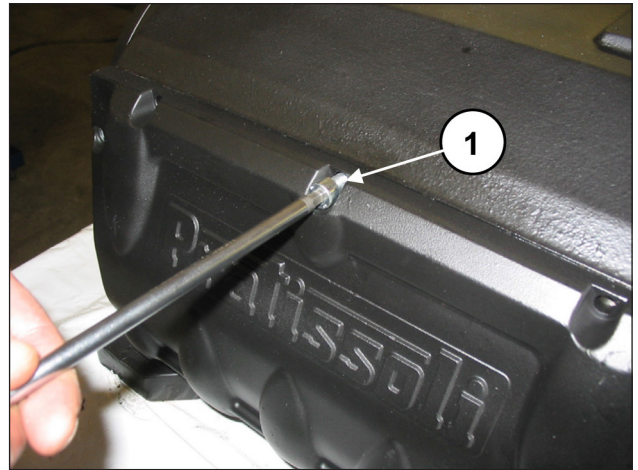

Abb. 77

Beenden Sie den Einbau der Mechanik, indem Sie die Verschlüsse und die Hubösen samt O-Ring montieren. Füllen Sie Öl in das Gehäuse gemäß Angaben in der **Betriebs- und Wartungsanleitung**, Abschn. 7.4.

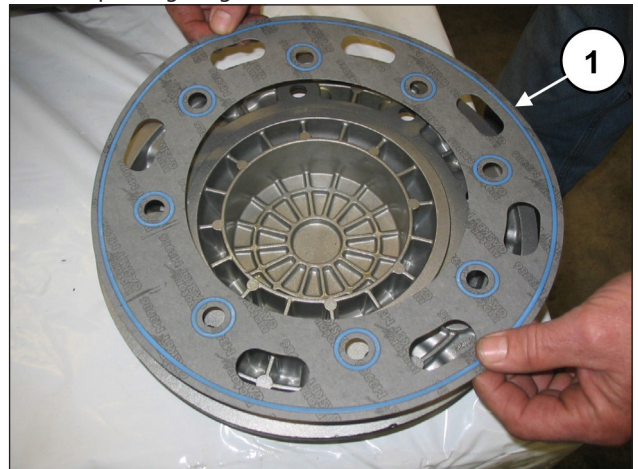
2.1.3 Vorgesehene Übermaßklassen

ÜBERMASSTABELLE FÜR KURBELWELLE UND PLEUEL-LAGERSCHALEN			
Ausgleichklassen (mm)	Art. obere Lagerschale	Art. untere Lagerschale	Schliff am Durchmesser des Wellenzapfens (mm)
0.25	90931100	90930100	Ø92.75 0/-0.03 Ra 0.4 Rt 3.5
0.50	90931200	90930200	Ø92.50 0/-0.03 Ra 0.4 Rt 3.5

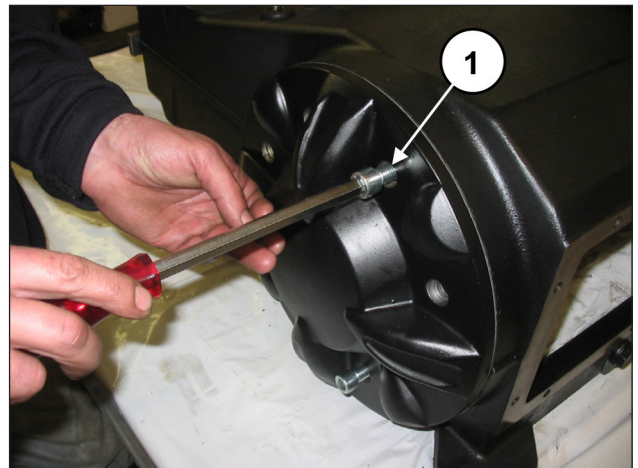
ÜBERMASSTABELLE FÜR PUMPENGEHÄUSE UND KOLBENFÜHRUNG		
Ausgleichklassen (mm)	Artikel Kolbenführung	Schliff am Sitz des Pumpengehäuses (mm)
1.00	79050543	Ø81 H6 +0.022/0 Ra 0.8 Rt 6

2.2 REPARATUR DER HYDRAULIK

2.2.1 Ausbau des Kopfs - Ventilgruppen

Der Kopf bedarf einer vorbeugenden Wartung lt. Angaben in der **Betriebs- und Wartungsanleitung**.

Die Arbeiten beschränken sich auf die Inspektion oder den Austausch der Ventile im Bedarfsfall.

Verfahren Sie zur Abnahme der Ventilgruppen wie folgt:
Lösen Sie die 8 Schrauben M16x55 des Ventildeckels (Pos. ①, Abb. 78) und nehmen Sie den Deckel ab (Pos. ①, Abb. 79).



Abb. 78



Abb. 79

Entfernen Sie die Ventilkappe mithilfe eines Abziehers mit Schlagwerk an der Bohrung M10 der Ventilkappe (Pos. ①, Abb. 80).

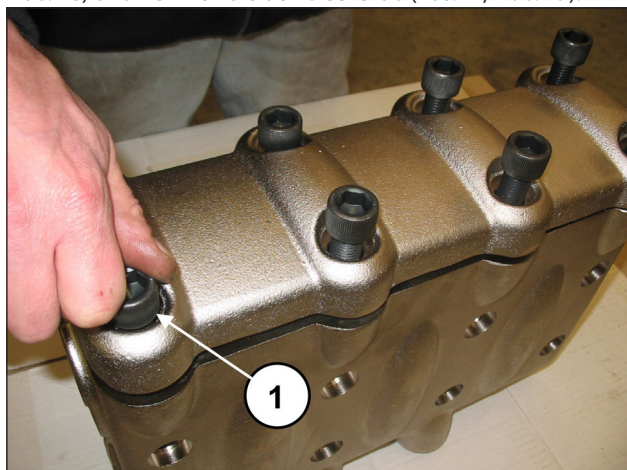

Abb. 80

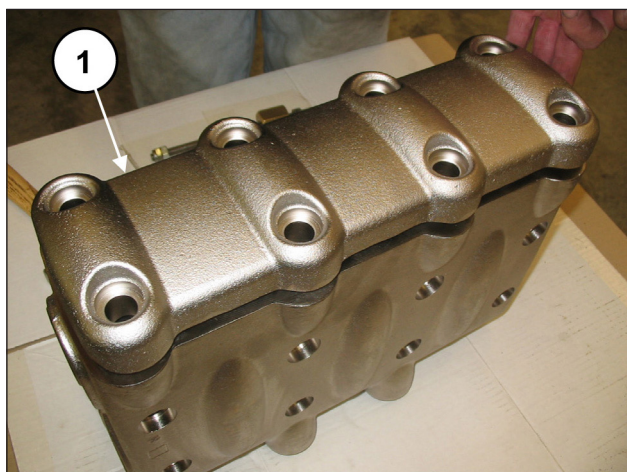
Entfernen Sie die Feder (Pos. ①, Abb. 81).

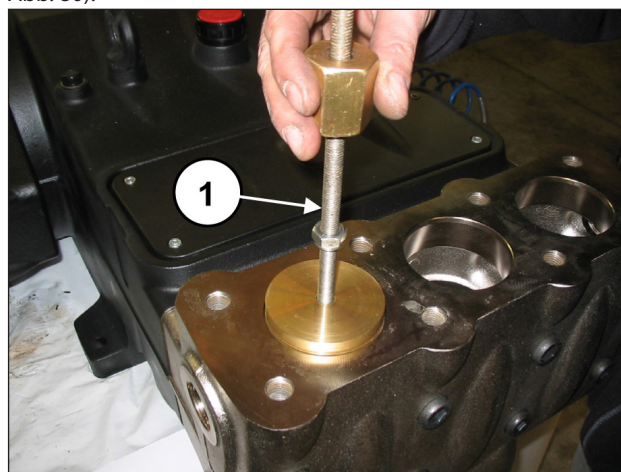

Abb. 81

Entfernen Sie die Druckventilgruppe mithilfe eines Abziehers mit Schlagwerk an der Bohrung M10 der Ventilführung (Pos. ①, Abb. 82).



Abb. 82

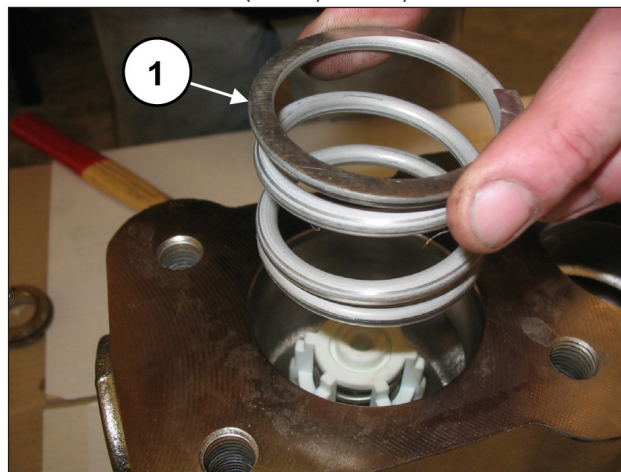

Sollte der Ausbau der Druckventilgruppe mit großen Schwierigkeiten verbunden sein (z. B. aufgrund von Verkrustungen nach längerem Stillstand der Pumpe), verwenden Sie den Abzieher Art. 27516400.

Ziehen Sie das Distanzstück der Ventilführung durch einen 8 mm Sechskantschlüssel heraus (Pos. ①, Abb. 83).

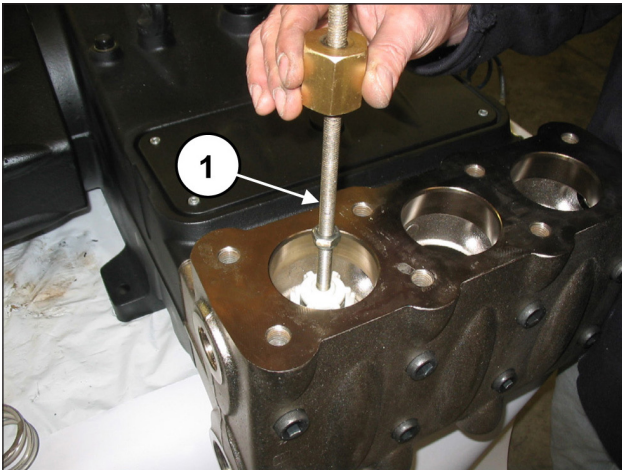

Abb. 83

Entfernen Sie die Druckventilgruppe mithilfe eines Abziehers mit Schlagwerk an der Bohrung M10 der Ventilführung (Pos. ①, Abb. 84).



Abb. 84

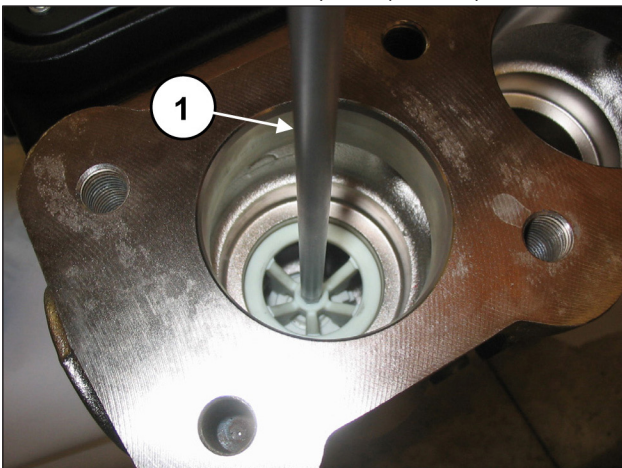

Sollte der Ausbau der Saugventilgruppe mit großen Schwierigkeiten verbunden sein (z. B. aufgrund von Verkrustungen nach längerem Stillstand der Pumpe), verwenden Sie den Abzieher Art.27516200 (in den Versionen mit Kolben-Ø: 40 - 45 - 50) oder Art.27516300 (in den Versionen mit Kolben-Ø: 55 - 60 - 65).

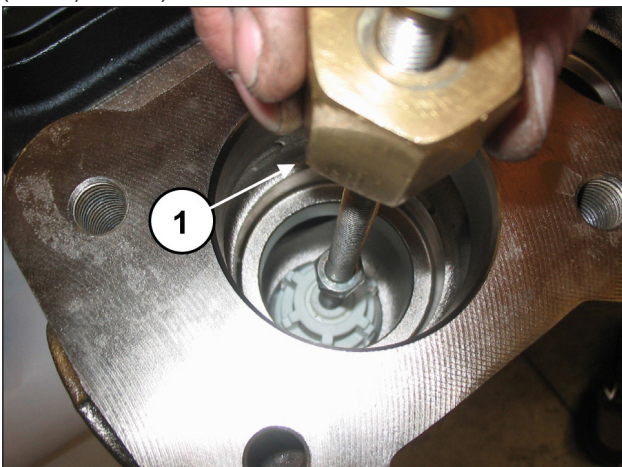

Abb. 85

Drehen Sie den Ventilöffner mit einem 30 mm Schlüssel ab (Pos. ①, Abb. 86).

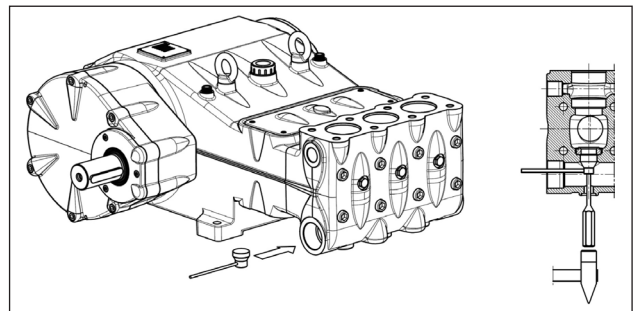

Abb. 86

Bauen Sie die Saug- und Druckventilgruppen durch Anziehen einer Schraube M10 aus, um durch Drücken auf die innere Führung die Ventilführung aus dem Ventil Sitz herausziehen zu können (Pos. ①, Abb. 87).

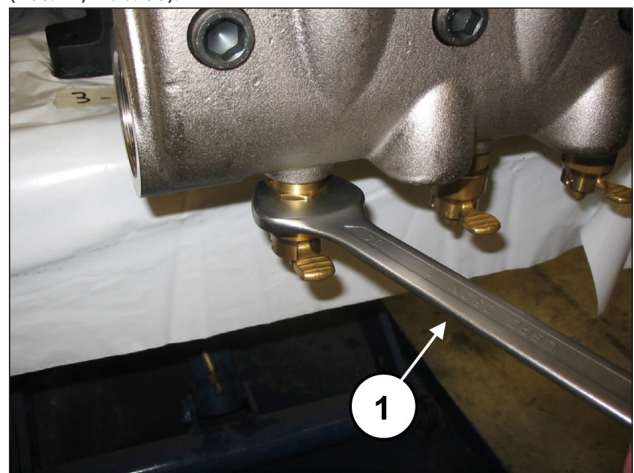

Abb. 87

2.2.2 Einbau des Kopfs - Ventilgruppen

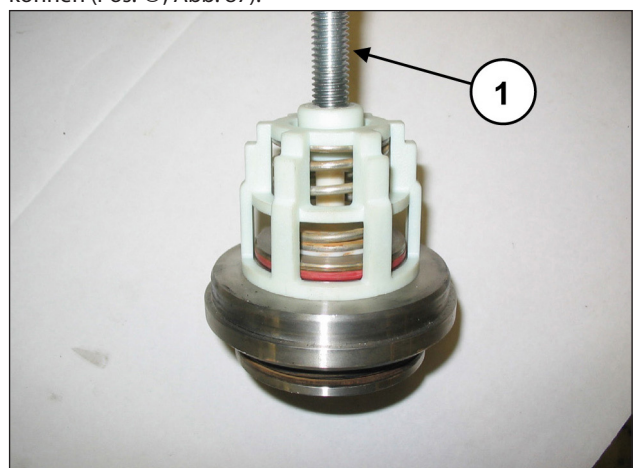

Achten Sie besonders auf den Verschleißzustand der einzelnen Bauteile und tauschen Sie diese bei Bedarf aus.

Ersetzen Sie bei jeder Inspektion der Ventile alle O-Ringe sowohl der Ventilgruppen als auch der Ventilkappen.



Vor dem Wiedereinbau der Ventilgruppen reinigen und trocknen Sie gründlich ihre Sitze im Kopf, siehe Pfeile (Pos. ①, Abb. 88).



Abb. 88

Verfahren Sie für den Wiedereinbau in umgekehrter Ausbaureihenfolge zu den Angaben in Abschn. 2.2.1. Achten Sie beim Einbau der Saug- und Druckventilgruppen (Abb. 89 und Abb. 90) darauf, nicht die vorab abgenommenen Federn zu vertauschen.

Um das Einsetzen der Ventilführung in den Sitz zu erleichtern, verwenden Sie ein Rohr, das auf den horizontalen Flächen der Führung aufliegt (Abb. 91) und benutzen Sie ein Schlagwerk am gesamten Umfang.

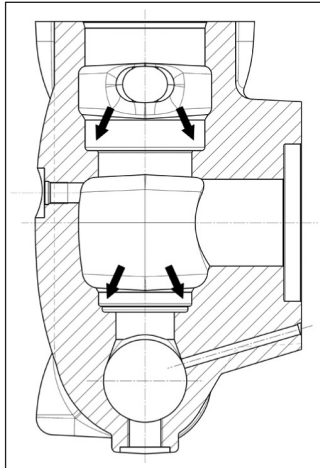

Abb. 89



Abb. 90



Abb. 91

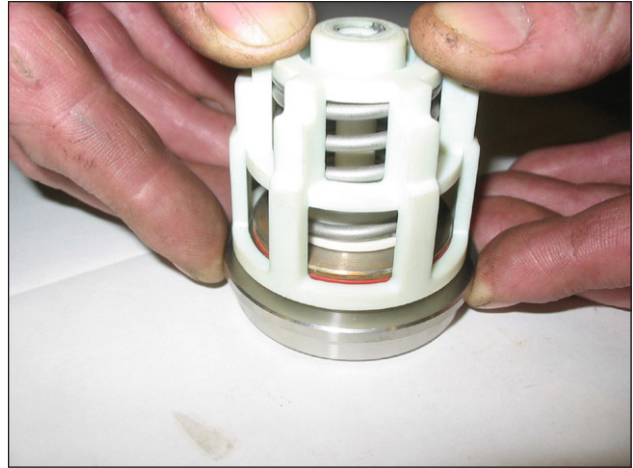

Achten Sie beim Einsetzen der Ventilgruppen (Saug- und Druckseite) in den Kopf auf die korrekte Einbaureihenfolge der O-Ringe und der Stützringe.

Die vorschriftsmäßige Einbaureihenfolge der Ventilgruppen in den Kopf lautet:

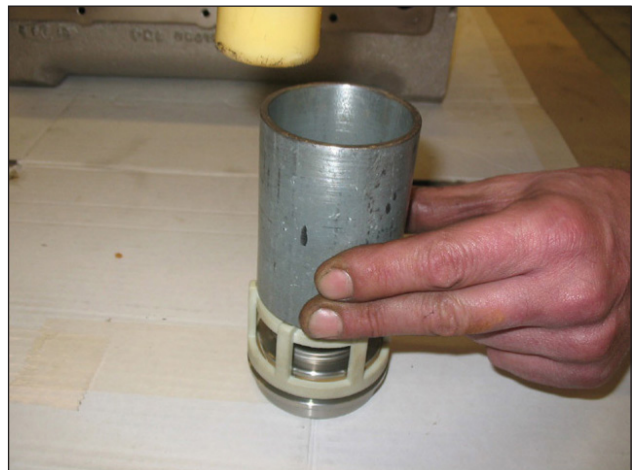
Setzen Sie den Stützring ein, Pos. 4 Explosionszeichnung (Pos. ①, Abb. 92).



Abb. 92

Setzen Sie den O-Ring ein, Pos. 5 Explosionszeichnung (Pos. ①, Abb. 93).

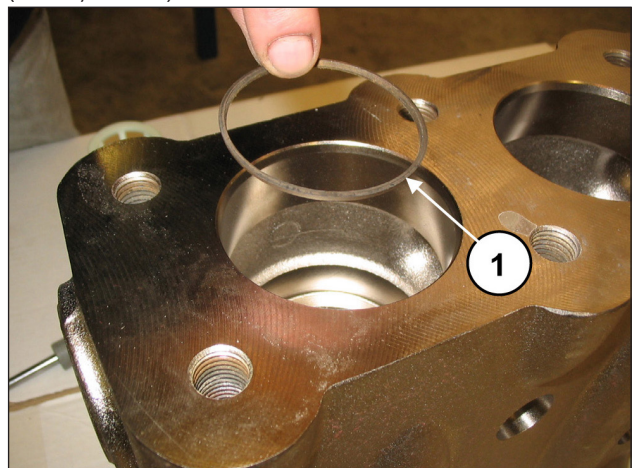

Abb. 93

Vergewissern Sie sich, dass O- und Stützring bündig im Sitz montiert sind.

Setzen Sie die Saugventilgruppe ein (Pos. ①, Abb. 94) und anschließend das Distanzstück (Pos. ①, Abb. 95).

Die komplette Ventilgruppe muss bündig eingesetzt sein und so erscheinen wie in Pos. ①, Abb. 95.

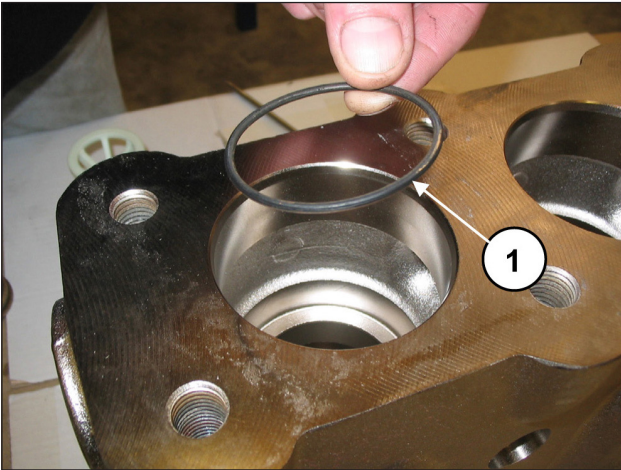

Abb. 94



Abb. 95

Montieren Sie den O-Ring, Pos. 5 Explosionszeichnung (Pos. ①, Abb. 96) und den Stützring, Pos. 15 Explosionszeichnung (Pos. ②, Abb. 96) auf den Sitz des Druckventils.

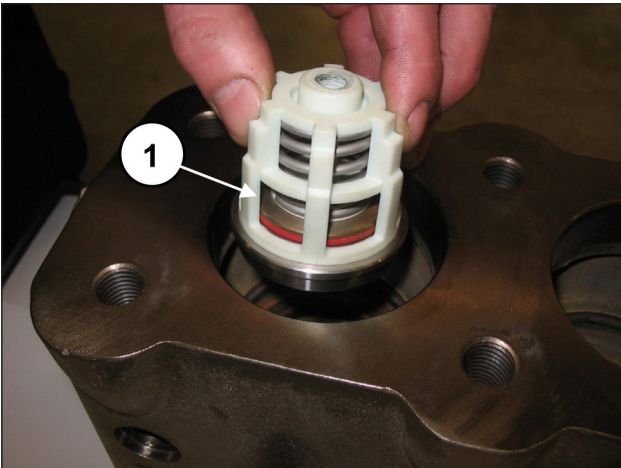

Abb. 96

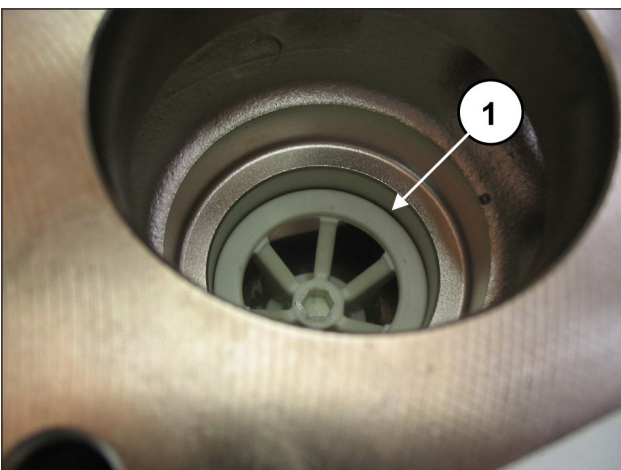
Setzen Sie die Druckventilgruppe ein (Pos. ①, Abb. 97). Die Ventilgruppe muss bündig eingesetzt sein und so erscheinen wie in Pos. ①, Abb. 98.



Abb. 97

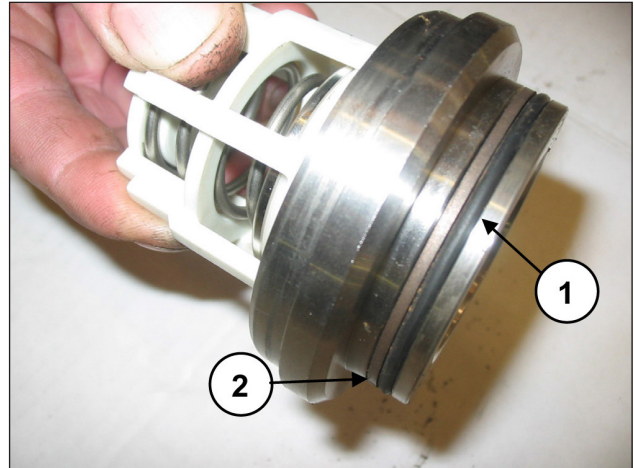

Abb. 98

Setzen Sie den Stützring ein, Pos. 16 Explosionszeichnung (Pos. ①, Abb. 99).

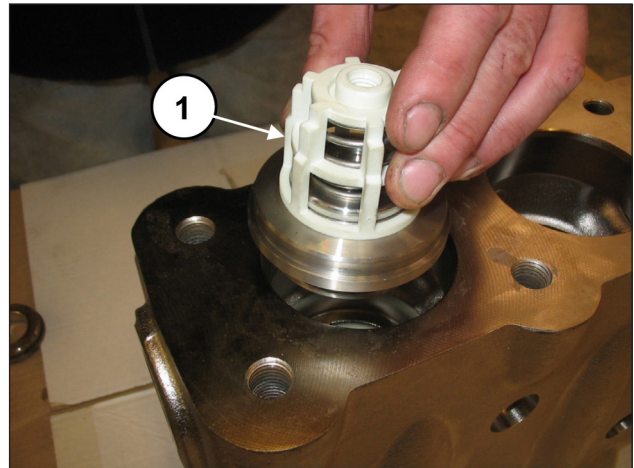

Abb. 99

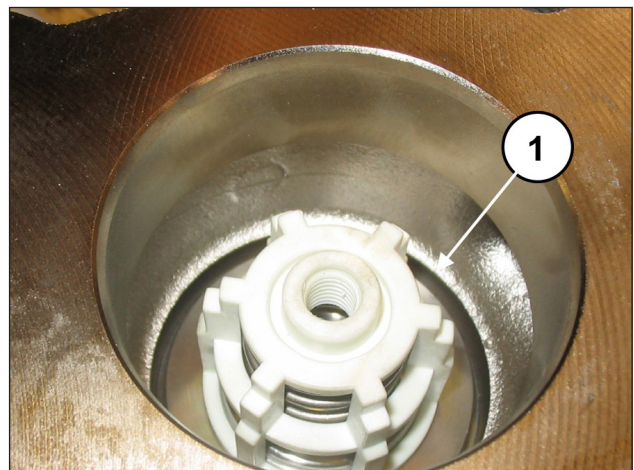
Setzen Sie den Ring des Ventilsitzes (Pos. ①, Abb. 102) und die Feder ein (Pos. ①, Abb. 103).

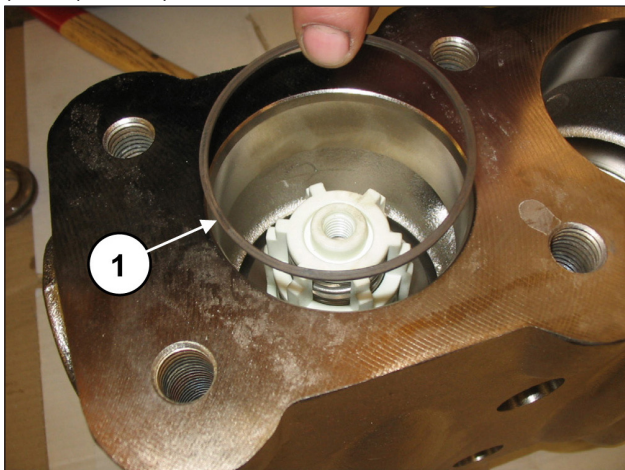

Abb. 102

Setzen Sie den O-Ring ein, Pos. 17 Explosionszeichnung (Pos. ①, Abb. 100).



Abb. 100

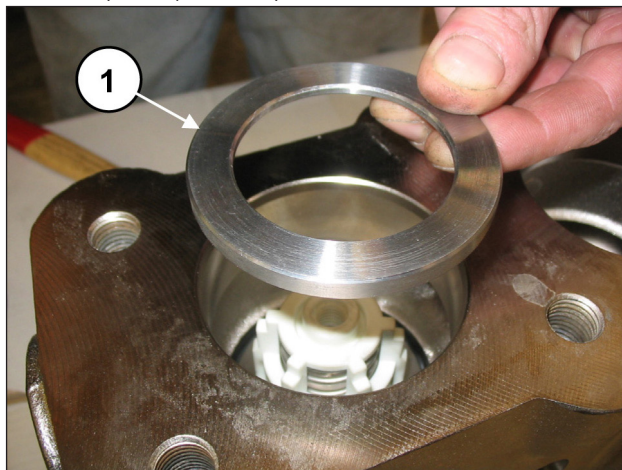

Abb. 103

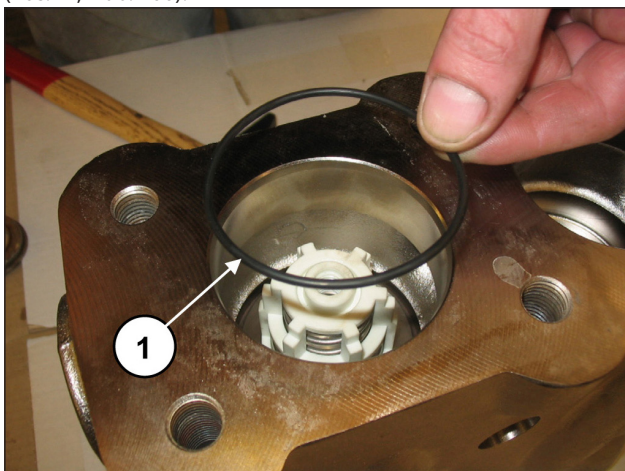

Achten Sie besonders auf das Einsetzen des O-Rings Pos. ①, Abb. 101. Verwenden Sie das Werkzeug Art. 27516000 (in den Versionen mit Kolben-Ø: 40 - 45 - 50) oder Art.27516100 (in den Versionen mit Kolben-Ø: 55- 60- 65, damit der O-Ring beim Einsetzen nicht reißt.

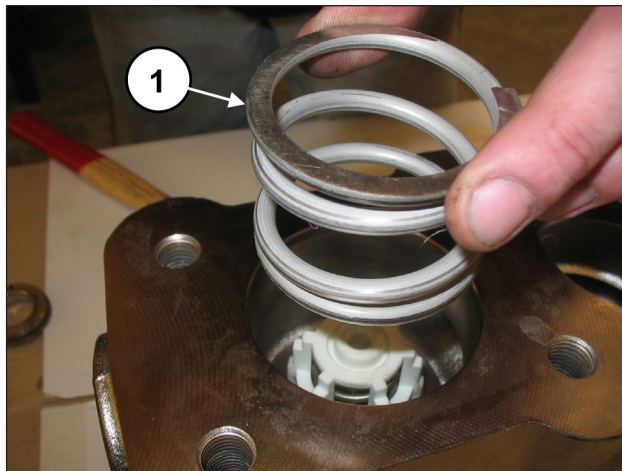

Abb. 101

Montieren Sie den O-Ring, Pos. 17 Explosionszeichnung (Pos. ①, Abb. 104) und den Stützring, Pos. 21 Explosionszeichnung (Pos. ②, Abb. 104) auf die Druckventilkappe.

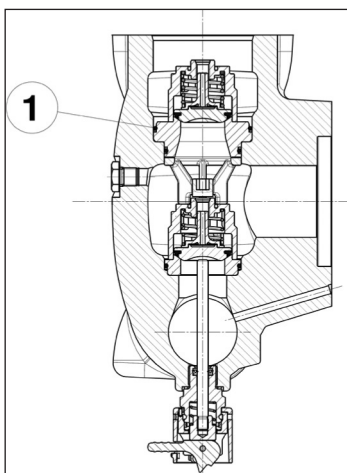

Abb. 104

Setzen Sie die Ventilkappe samt O-Ring und Stützring ein. Bringen Sie nach Montage der Ventilgruppen und Ventilkappen den Ventildeckel an (Pos. ①, Abb. 105) und ziehen Sie die 8 Schrauben M16x55 fest (Pos. ①, Abb. 106).



Abb. 105

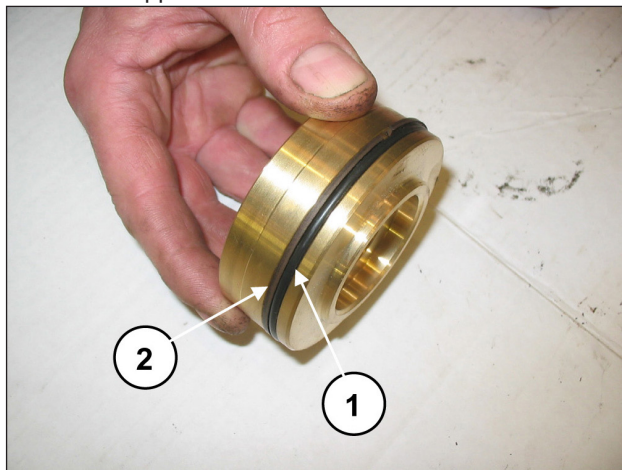

Abb. 106

Bauen Sie den Kopf auf das Pumpengehäuse an (Pos. ①, Abb. 107) und achten Sie dabei, nicht gegen die Kolben zu stoßen. Ziehen Sie dann die 8 Schrauben M16x180 fest (Pos. ①, Abb. 108).

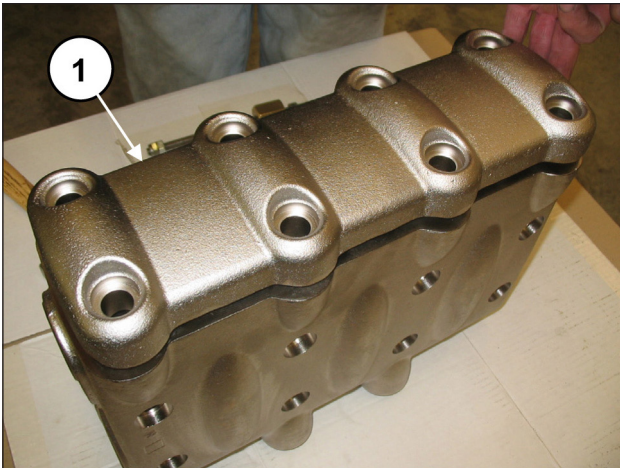

Abb. 107

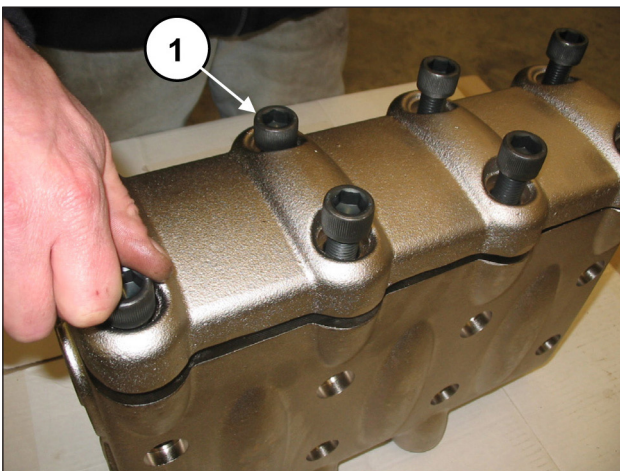

Abb. 108

Eichen Sie die Schrauben M16x180 mit einem Drehmomentschlüssel, wie in Kapitel 3 gezeigt.

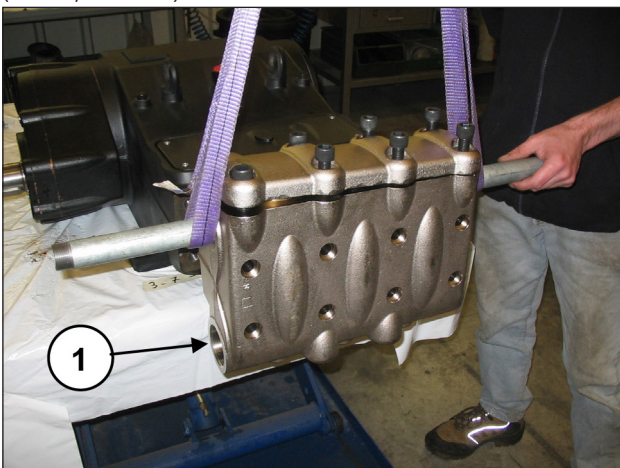

Ziehen Sie die 8 Schrauben M16x180 von den 4 Innenschrauben ausgehend über Kreuz an (siehe Abb. 107), setzen Sie den Anzug dann mit den 4 Außenschrauben ebenfalls über Kreuz fort

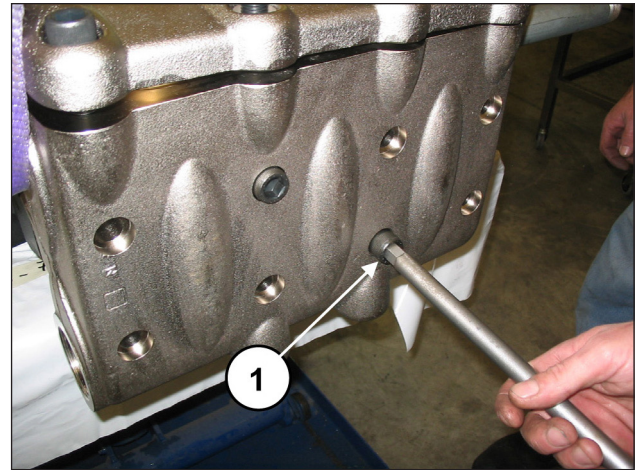
Eichen Sie die Schrauben M16x55 des Deckels mit einem Drehmomentschlüssel, wie in Kapitel 3 gezeigt. Bringen Sie die Ventilöffner an (Pos. ①, Abb. 109) und drehen Sie diese mit einem 30 mm Schlüssel fest (Pos. ①, Abb. 110).



Abb. 109



Abb. 110

2.2.3 Ausbau der Kolbengruppe - Lager - Dichtungen

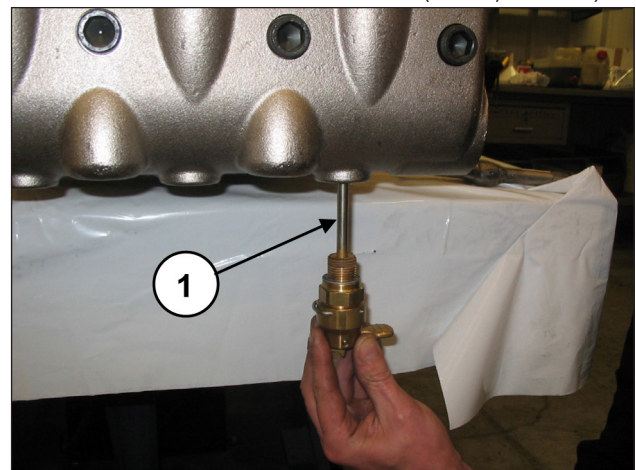
Die Kolbengruppe bedarf einer regelmäßigen Prüfung lt. Angaben in der Tabelle der vorbeugenden Wartung der **Betriebs- und Wartungsanleitung**.

Die Eingriffe beschränken sich lediglich auf die Sichtprüfung der Ablassbohrung am unteren Deckel. Sollten Störungen / Schwingungen am Druckmanometer oder Tropferscheinungen aus der Ablassbohrung auftreten, muss das Dichtungspaket überprüft und ggf. ausgetauscht werden. Verfahren Sie zur Abnahme der Kolbenbaugruppen wie folgt: Lösen Sie für den Zugriff auf die Kolbengruppe die Schrauben M16x180 und bauen Sie den Kopf aus.

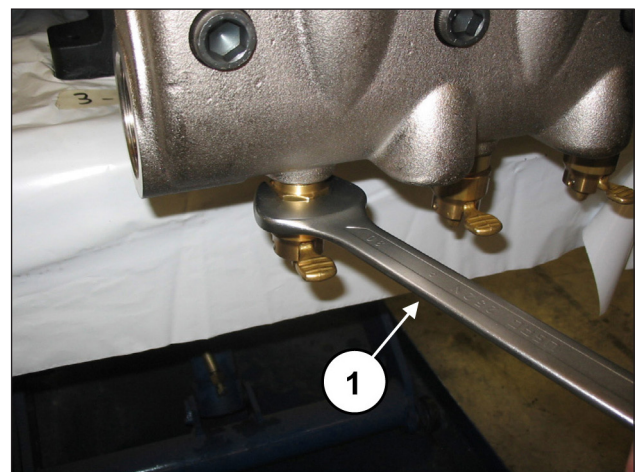

Ziehen Sie den Kopf mit größter Vorsicht heraus, um nicht gegen die Kolben zu stoßen

Demontieren Sie die Kolben durch Abdrehen der Befestigungsschrauben (Pos. ①, Abb. 111).

Streifen Sie den Kolben aus dem Dichtungshalter und überprüfen Sie die Kolbenoberfläche auf etwaige Kratzer, Verschleiß- oder Kavitationsanzeichen



Abb. 111

Demontieren Sie den oberen Inspektionsdeckel durch Abdrehen der 4 Befestigungsschrauben (Pos. ①, Abb. 112).

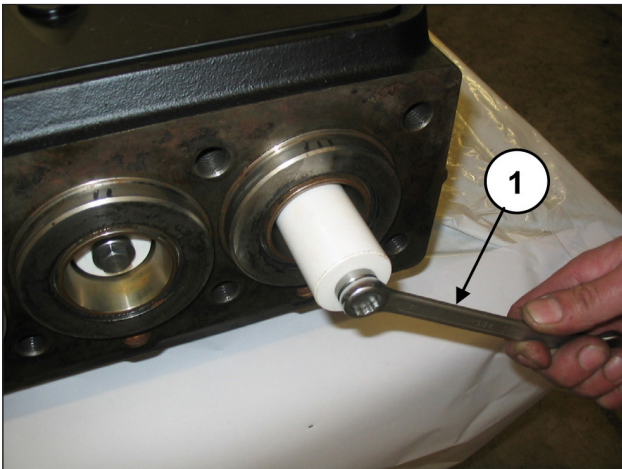

Abb. 112

Drehen Sie die Welle von Hand so, dass die 3 Kolben an ihren oberen Totpunkt bewegt werden.

Setzen Sie den Dorn Art. 27516600 zwischen Kolbenführung und Kolben ein (Pos. ①, Abb. 113).

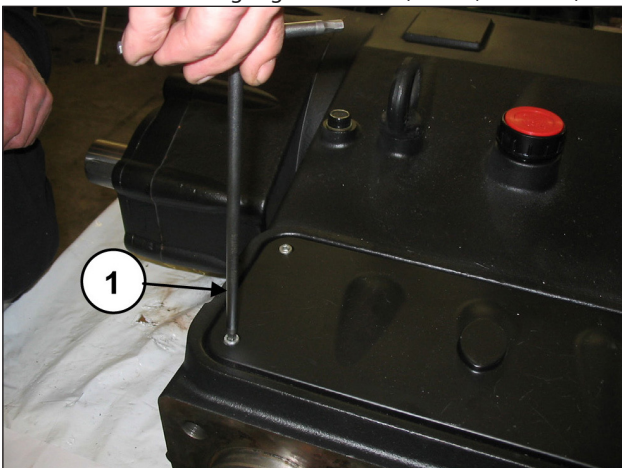

Abb. 113

Schieben Sie die Kolbenführung durch Drehen der Welle soweit vor, dass der mitgetriebene Dorn den Dichtungshalter und die gesamte Kolbenbaugruppe herausdrückt (Pos. ①, Abb. 114).

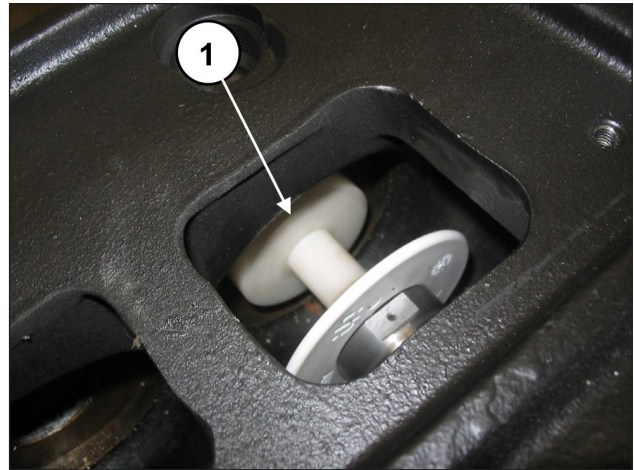

Abb. 114

Entfernen Sie den Dichtungshalter und den Dorn. Nehmen Sie den O-Ring am Boden des Dichtungshalters ab, sollte er im Pumpengehäuse verblieben sein (Pos. ①, Abb. 115).

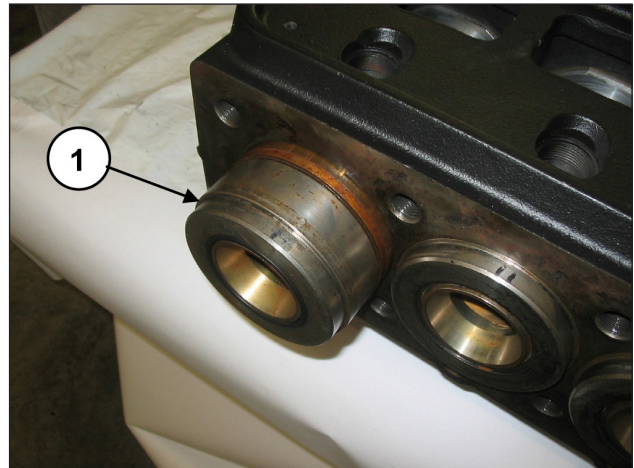

Abb. 115

Entfernen Sie die Spritzschutzringe von den Kolbenführungen (Pos. ①, Abb. 116).

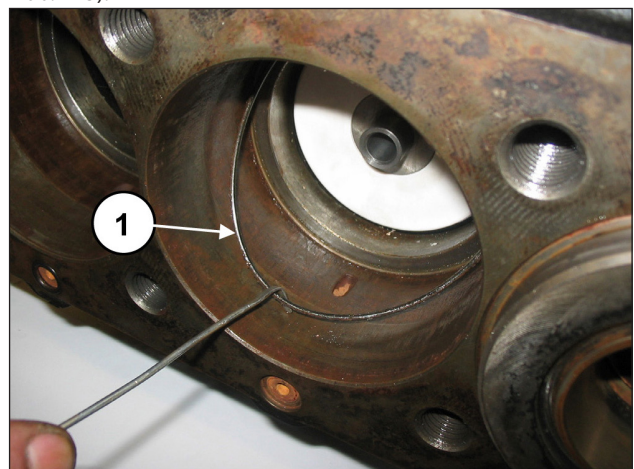

Abb. 116

Sollte der Austausch des Ölabbstreifings der Kolbenführung erforderlich sein, gehen Sie zum Ausbau des Ölabbstreifing-Deckels folgendermaßen vor:
Lösen Sie die zwei Befestigungsschrauben des Ölabbstreifing-Deckels (Pos. ①, Abb. 117).

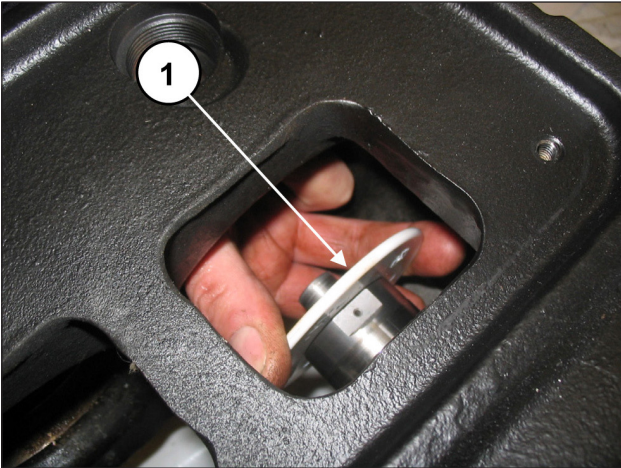

Abb. 117

Bringen Sie die Kolbenführungen auf den unteren Totpunkt, drehen Sie den Abzieher Art. 27516400 mit Adapter M5 Art. 27516500 in die entsprechenden Bohrungen am Deckel ein (Pos. ①, Abb. 118) und nehmen Sie den Ölabbstreifing-Deckel von der Pumpengruppe ab (Pos. ①, Abb. 119).



Abb. 118

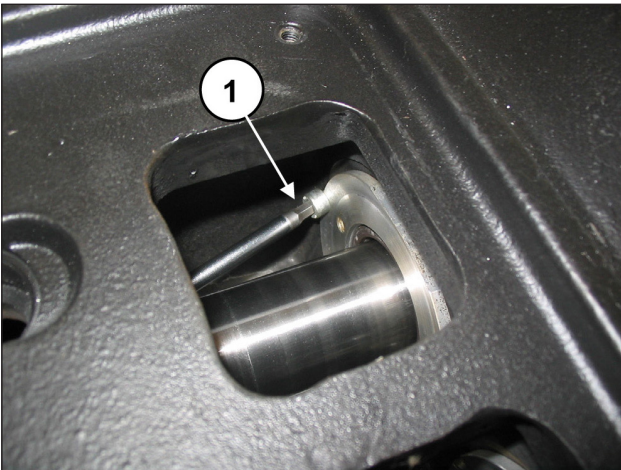

Abb. 119

Ersetzen Sie den Ölabbstreifring (Pos. ①, Abb. 120) und den äußeren O-Ring (Pos. ②, Abb. 120).

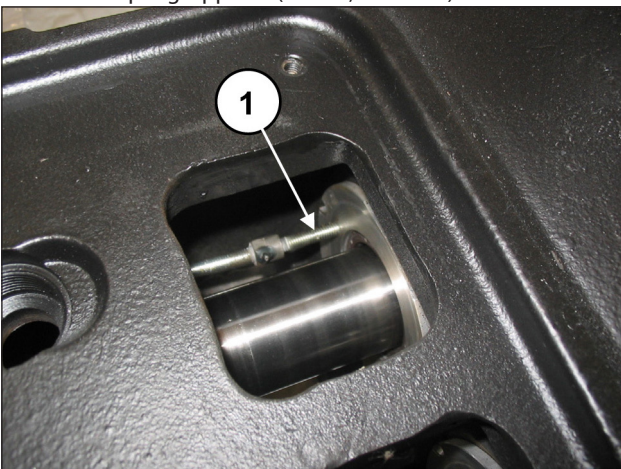

Abb. 120

Trennen Sie den Dichtungshalter von der Buchse (Pos. ①, Abb. 121), um die Druckdichtungen freizulegen (Pos. ①, Abb. 122).



Abb. 121

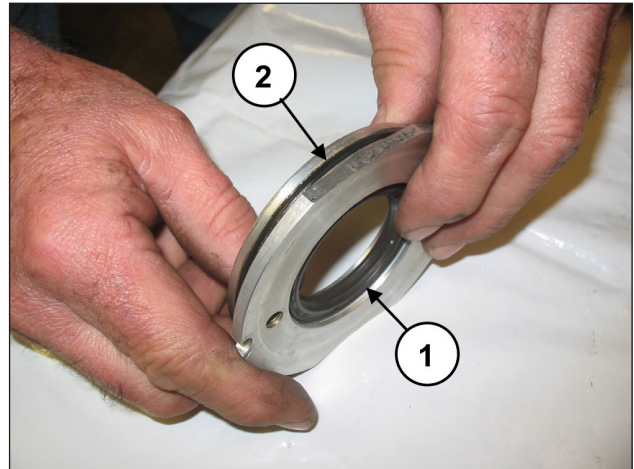

Abb. 122

Zur Abnahme der ND-Dichtung müssen Sie eine Fühlerlehre oder ein ähnliches Werkzeug verwenden, das den Sitz des Dichtungshalters nicht beschädigt (Pos. ①, Abb. 123).

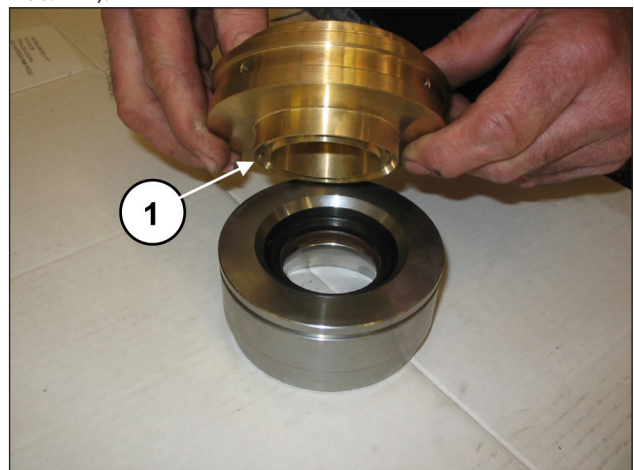

Abb. 123

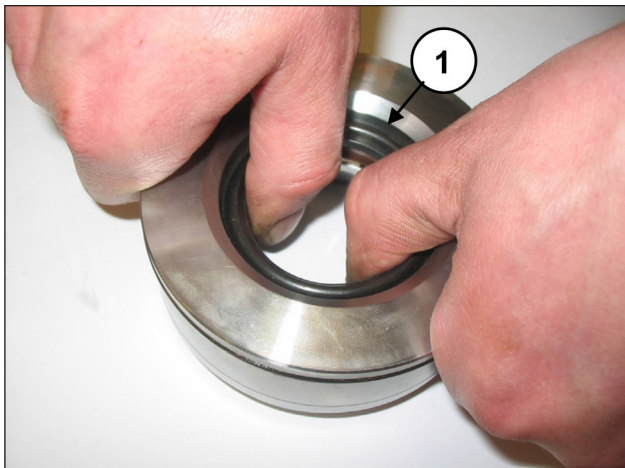
2.2.4 Einbau der Kolbengruppe - Lager - Dichtungen
Verfahren Sie für den Wiedereinbau in umgekehrter Ausbaureihenfolge zu den Angaben in Abschn. 2.2.3.



Ersetzen Sie die Druckdichtungen, indem Sie die Dichtlippen mit Silikonfett befeuchten (nicht bestreichen). Achten Sie besonders darauf, die Dichtungen beim Einsetzen in die Buchse nicht zu beschädigen.

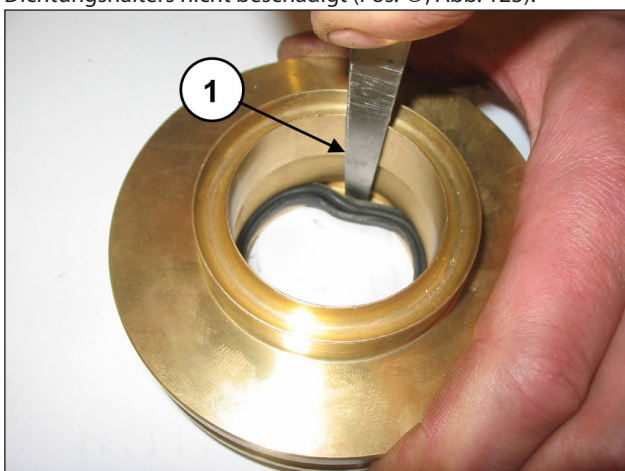

Bei jedem Ausbau müssen die Druckdichtungen mit sämtlichen O-Ringen ersetzt werden.

Setzen Sie die ND-Dichtung in den Dichtungshalter ein (Pos. ①, Abb. 124) und achten Sie hierbei auf die Einbaurichtung mit nach vorn gerichteter Dichtlippe (zum Kopf hin).



Abb. 124

Montieren Sie den Kopfring (Pos. ①, Abb. 125), die HD-Dichtung (Pos. ①, Abb. 126) und den Restop-Ring (Pos. ①, Abb. 127).



Abb. 125

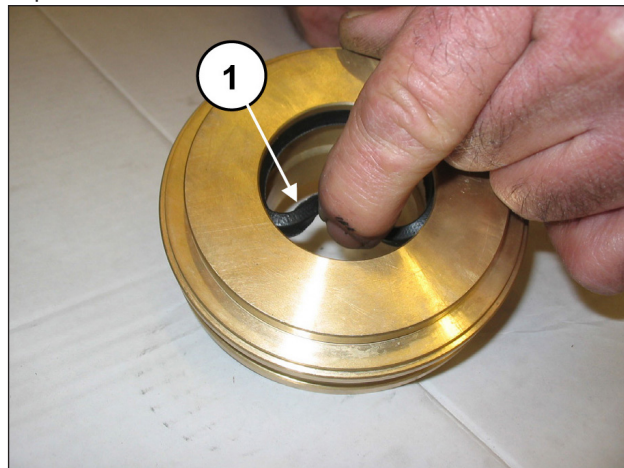

Abb. 126



Abb. 127

Verbinden Sie Dichtungshalter mit Buchse (Pos. ①, Abb. 128).

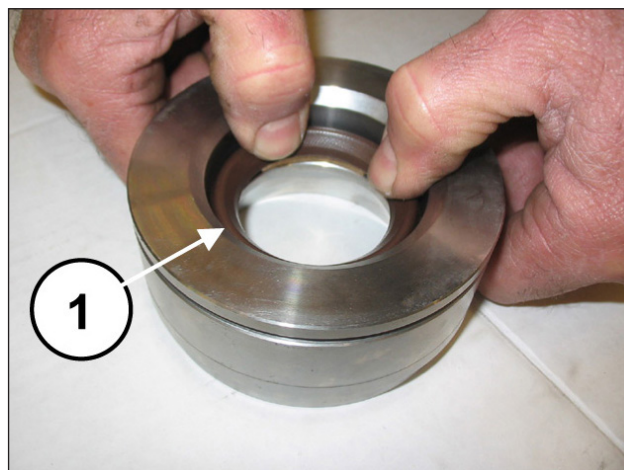

Abb. 128

Montieren Sie den Ölabbstreifer in seinen Deckel (Pos. ①, Abb. 129) mithilfe eines Dorns Art. 27910900.

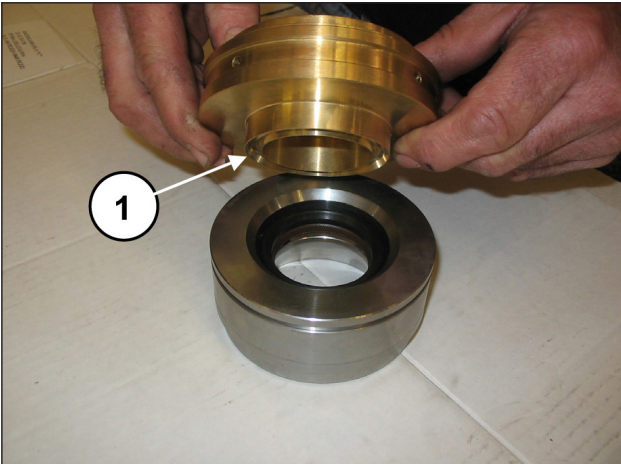

Abb. 129

Setzen Sie den O-Ring (Pos. ①, Abb. 130) in die Aufnahme des Ölabbstreifer-Deckels ein und bringen Sie die montierte Gruppe in den Gehäusesitz an (Pos. ①, Abb. 131).



Abb. 130

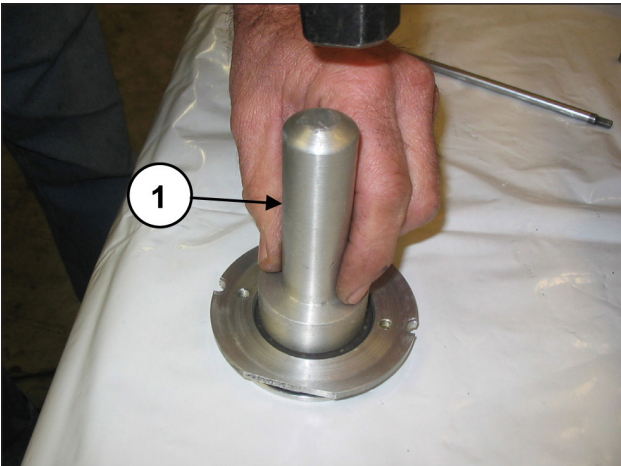

Abb. 131

Überprüfen Sie den passgerechten Sitz des Deckels (Pos. ①, Abb. 132) und achten Sie darauf, nicht die Dichtlippe des Ölabbstreifers zu beschädigen. Befestigen Sie die Ölabbstreifer-Deckel anhand von 2 Schrauben M6x14 (Pos. ①, Abb. 133).

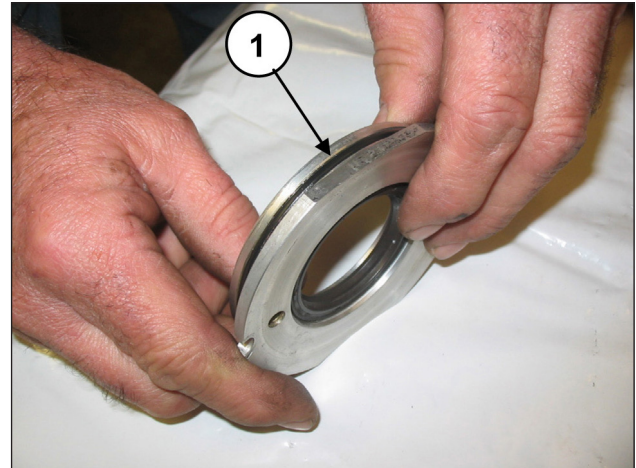

Abb. 132

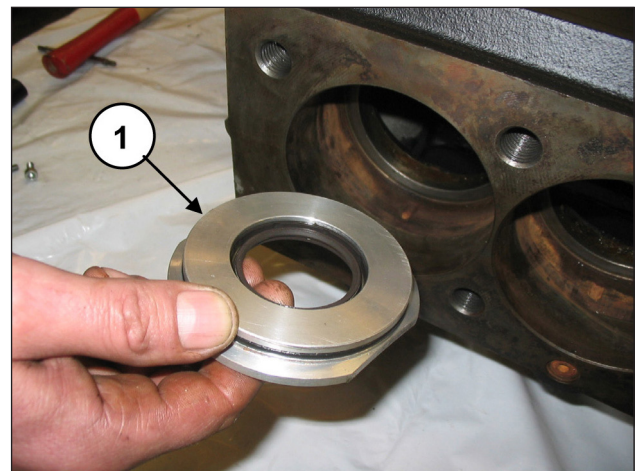

Abb. 133

Eichen Sie die Schrauben mit einem Drehmomentschlüssel, wie in Kapitel 3 gezeigt.
Montieren Sie den Spritzschutz samt O-Ring in die Aufnahme an der Kolbenführung (Pos. ①, Abb. 134 und Abb. 135).

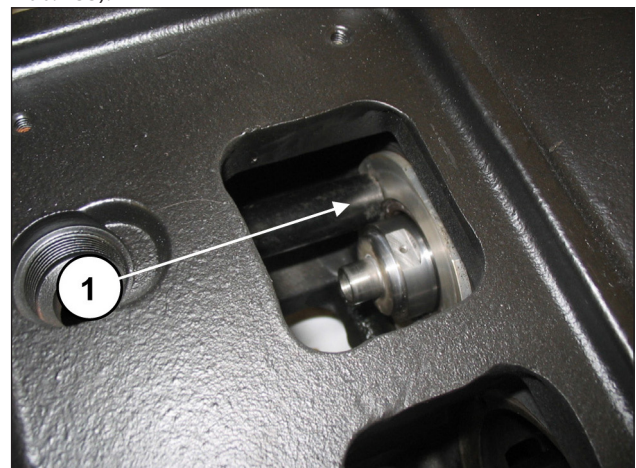

Abb. 134

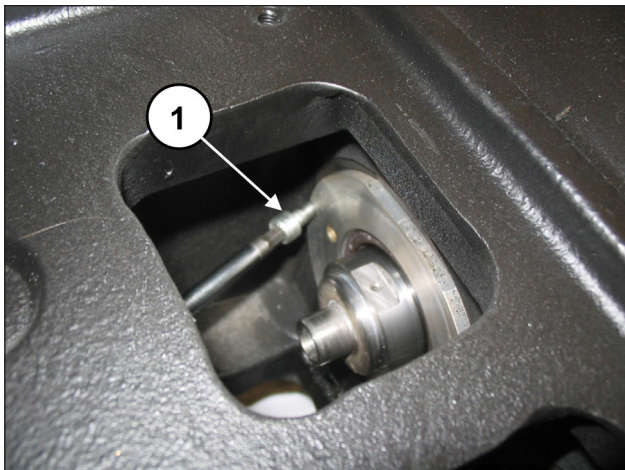

Abb. 135

Setzen Sie die Unterlegscheibe $\text{\O}10 \times 18 \times 0,9$ auf die Befestigungsschraube des Kolbens (Pos. ①, Abb. 136).

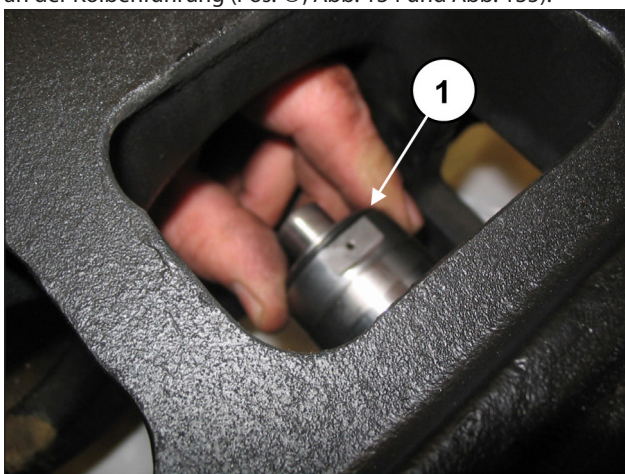

Abb. 136

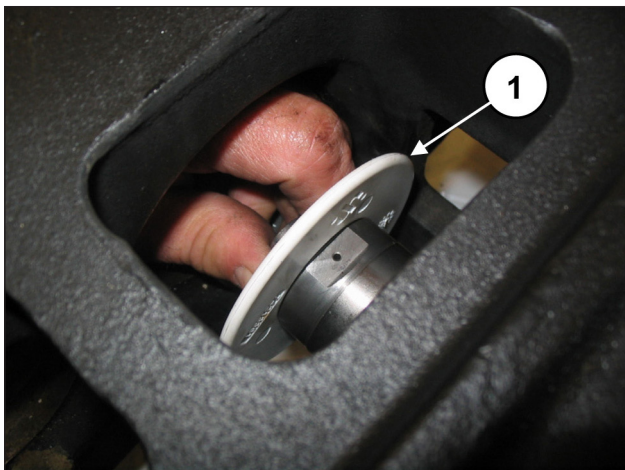
Montieren Sie die Kolben in die entsprechenden Führungen (Pos. ①, Abb. 137) und befestigen Sie diese lt. Pos. ①, Abb. 138.



Abb. 137

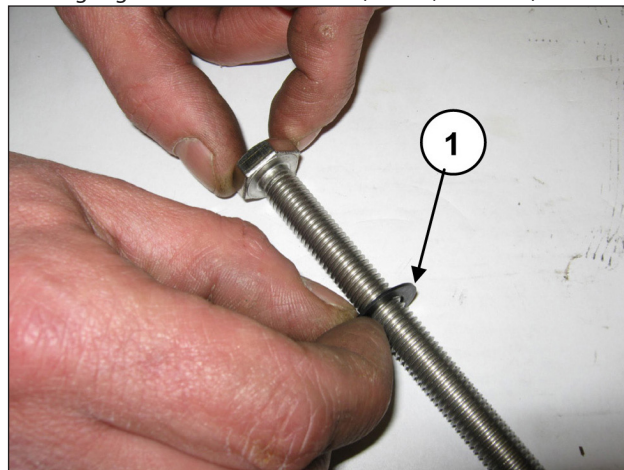

Abb. 138

Eichen Sie die Schrauben mit einem Drehmomentschlüssel, wie in Kapitel 3 gezeigt.

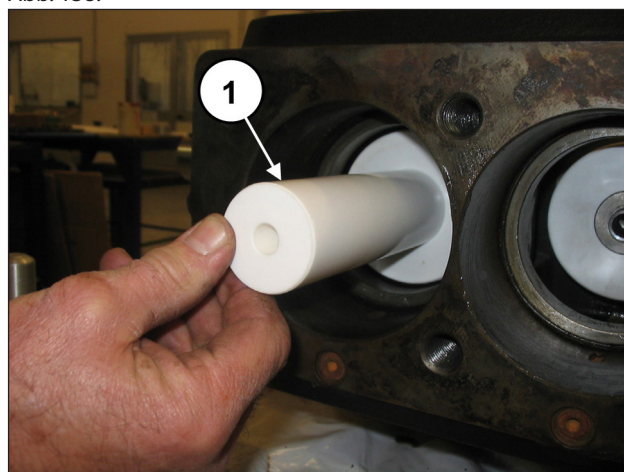
Montieren Sie den O-Ring in das Pumpengehäuse (Pos. ①, Abb. 139) und anschließend die vorab zusammengebaute Gruppe Buchse-Dichtungshalter (mitsamt O-Ring) bis auf Anschlag (Pos. ①, Abb. 140).

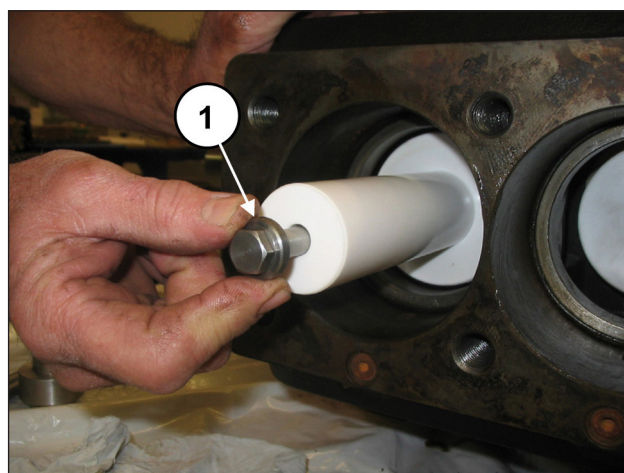

Abb. 139



Abb. 140

Vergewissern Sie sich, dass die Gruppe Buchse-Dichtungshalter bündig in ihrem Sitz liegt (Pos. ①, Abb. 141).

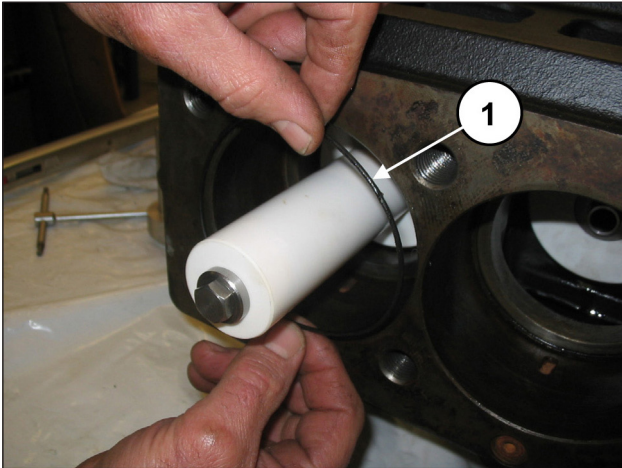

Abb. 141

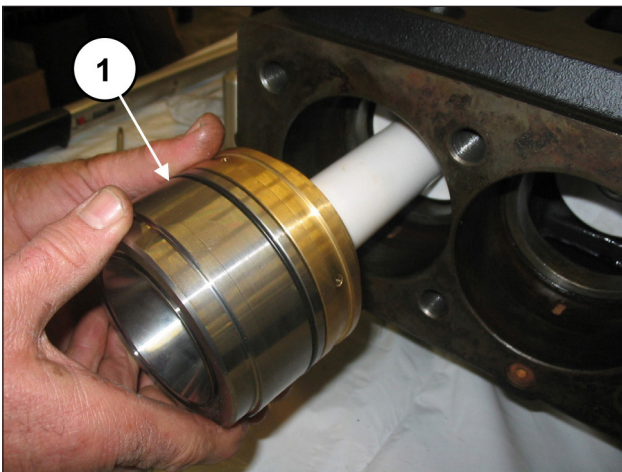
Setzen Sie den frontseitigen O-Ring der Buchse ein (Pos. ①, Abb. 142) und den O-Ring an der Umlaufbohrung (Pos. ①, Abb. 143).



Abb. 142

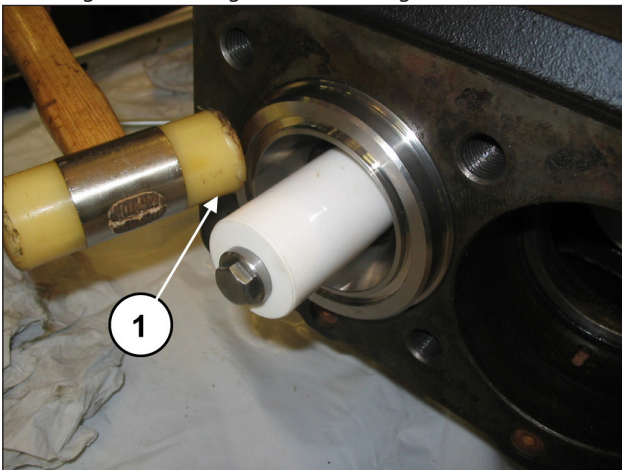

Abb. 143

Setzen Sie auf die Inspektionsdeckel den O-Ring (Pos. ①, Abb. 144) und montieren Sie die Deckel anhand von 4+4 Schrauben M6x14 (Pos. ①, Abb. 145).

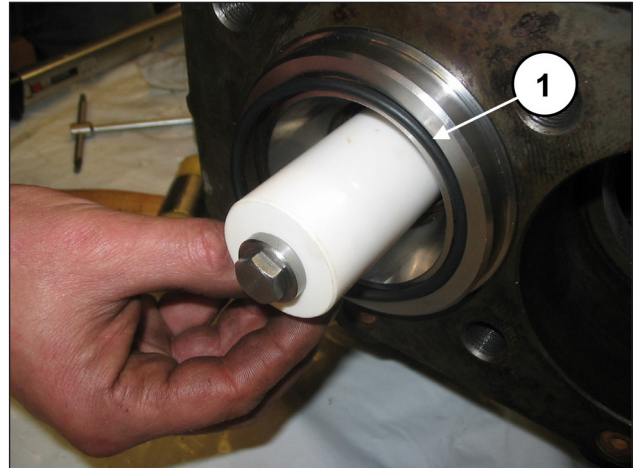

Abb. 144

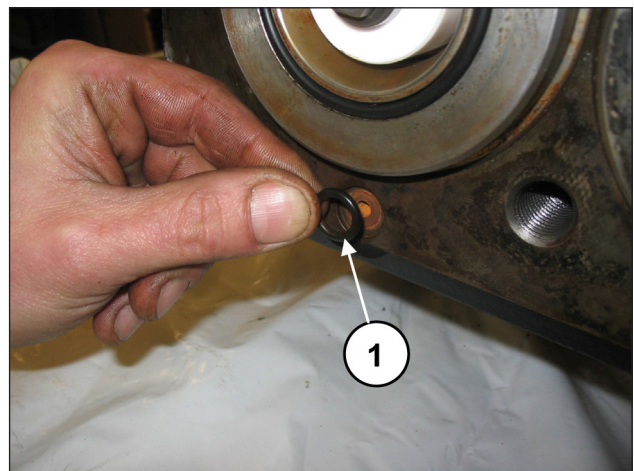

Abb. 145

Eichen Sie die Schrauben mit einem Drehmomentschlüssel, wie in Kapitel 3 gezeigt.

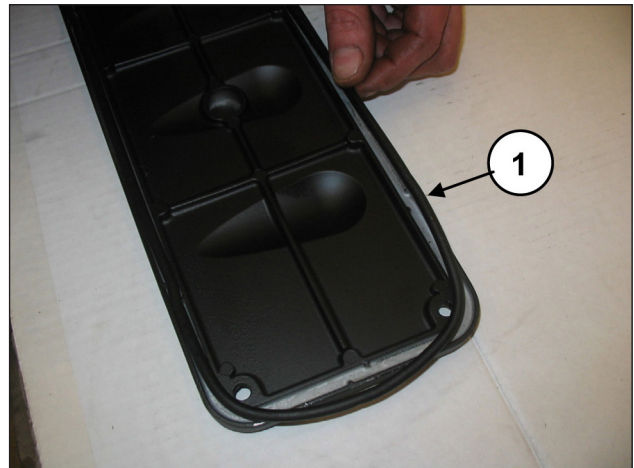
2.2.5 Wiederherstellung des Kopfs

Sollte der Kopf in den Kolbenkammern deutliche Kavitationsanzeichen infolge einer nicht korrekten Pumpenversorgung aufweisen, kann der beschädigte Kopf ohne Bedarf eines Austausch wiederhergestellt werden. Führen Sie zur Wiederherstellung des Kopfs die Bearbeitungen lt. Abb. 146 für die Versionen mit Kolben-Ø 40-45-50 aus, lt. Abb. 147 für die Versionen mit Kolben-Ø 55-60-65:

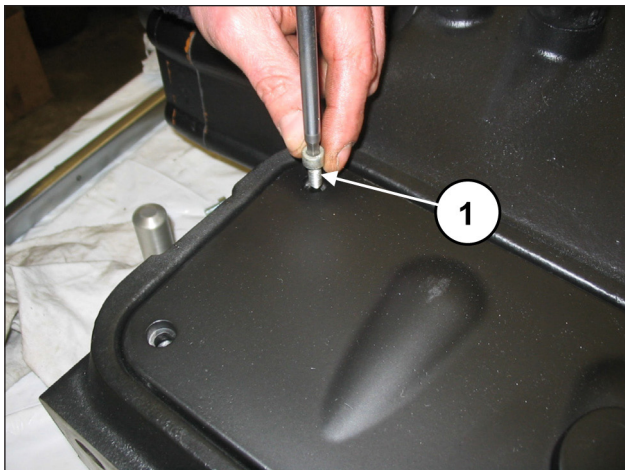

Abb. 146



Abb. 147

Bauen Sie den bearbeiteten Kopf durch Setzen der Buchsen (Pos. ①) samt Stützringen (Pos. ②) und O-Ring (Pos. ③) gemäß Abb. 148 für die Versionen mit Kolben-Ø40-45-50 und gemäß Abb. 149 für die Versionen mit Kolben-Ø 55-60-65 zusammen:

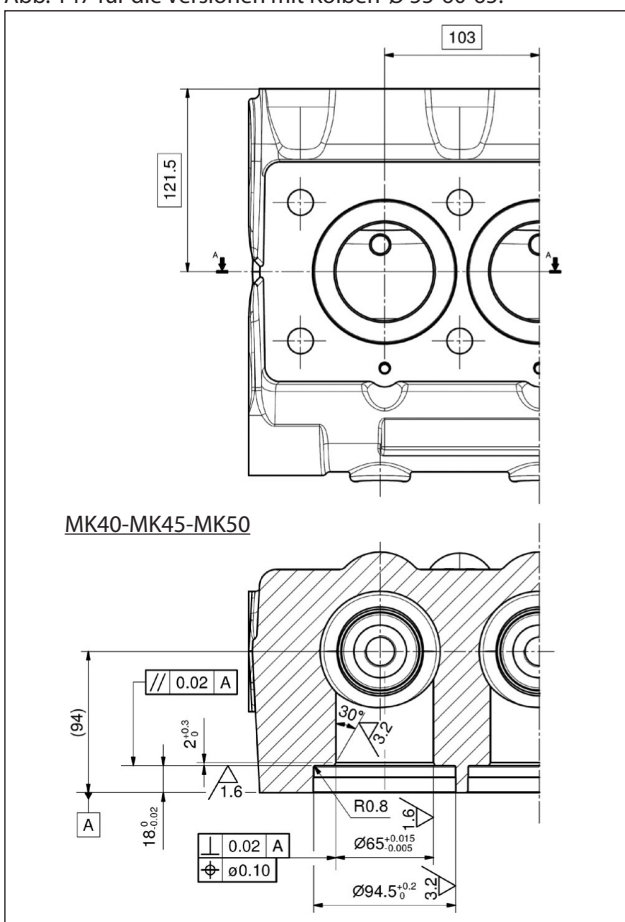

Abb. 148

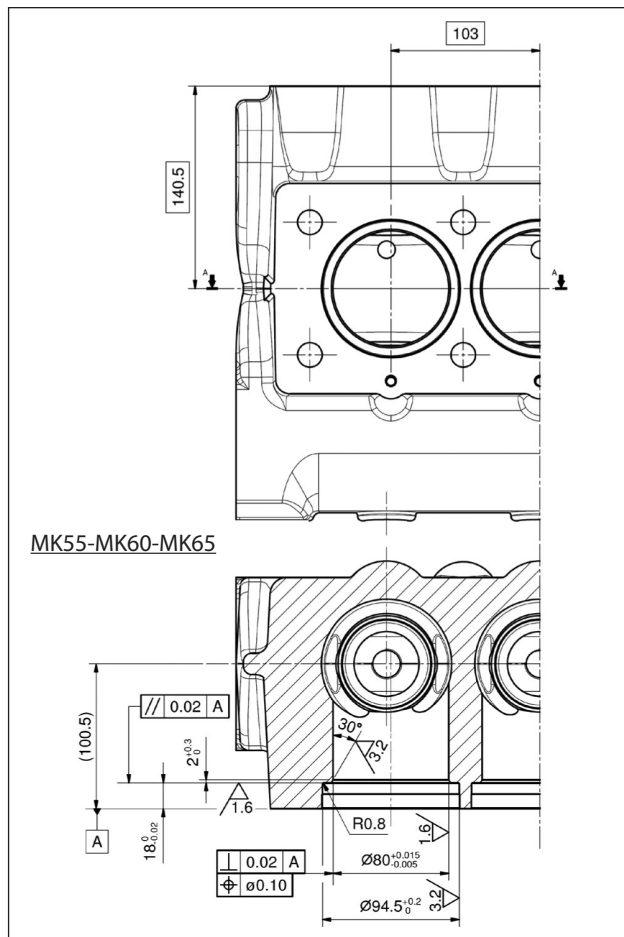
- 1 - Buchse für Versionen mit Kolben-Ø40-45-50 Art. 74215156
- Menge 3
- 2 - Stützring - Art. 90526880 - Menge 6
- 3 - O-Ring - Art. 90410200 - Menge

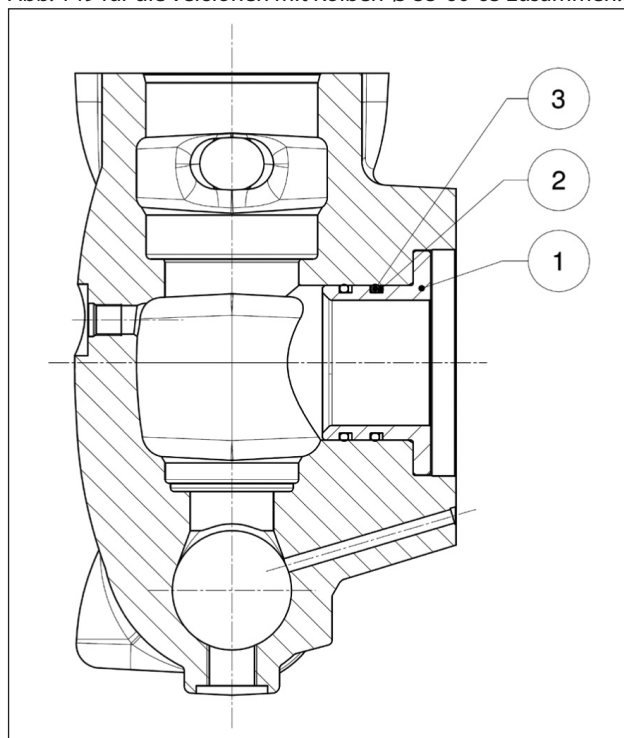

Abb. 149

- 1 - Buchse für Versionen mit Kolben-Ø55-60-65 Art.74215056
- Menge 3
- 2 - Stützring - Art.90528500 - Menge 6
- 3 - O-Ring - Art. 90412900 - Menge 6

3 EICHWERTE FÜR DEN SCHRAUBENANZUG

Ziehen Sie die Schrauben ausschließlich mit einem Drehmomentschlüssel fest.

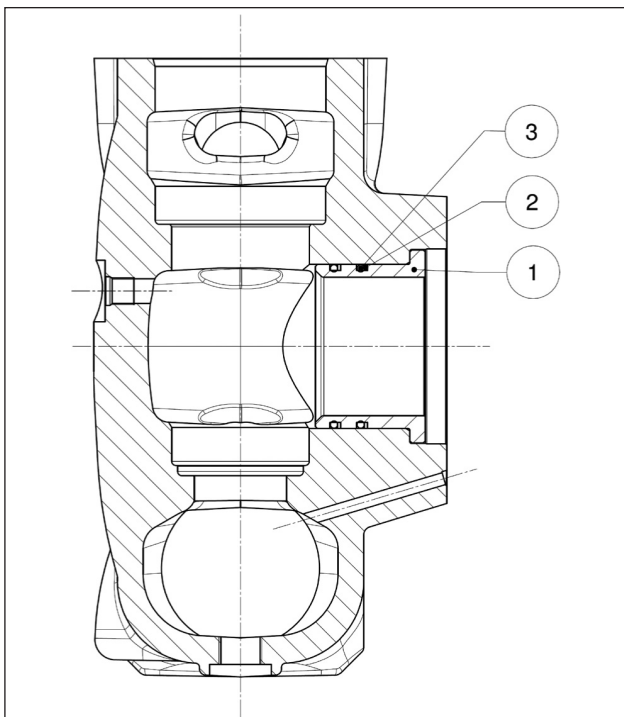
Beschreibung	Position Explosionszeichnung	Anzugsmoment Nm
Schraube M18x18 Gehäusedeckel	54	20
Verschluss G1/2x13 Gehäuse	55	40
Schraube M8x18 Getriebeflansch	54	20
Schraube M10x50 Getriebedeckel	70	45
Schraube M10x25 Zahnkranzarretierung	65	45
Schraube M12x40 Getriebegehäuse	75	73.5
Schraube M12x50 Getriebegehäuse	64	73.5
Schraube M6x14 oberer und unterer Deckel	41	10
Schraube M12x30 Lagerdeckel	90	40
Schraube M12x1.25x87 Pleuelbefestigung	53	75*
Schraube M6x20 Kolbenführung	49	10
Schraube M6x14 Ölabbstreifring-Deckel	41	10
Schraube M10x160 Kolbenbefestigung	27	40
Schraube M16x55 Ventildeckel	26	333
Verschluss G1/4"x13 Kopf	13	40
Schraube M16x180 Kopf	25	333**
Ventilöffner	2	40

* Ziehen Sie alle Schrauben gleichzeitig bis auf Anzugsmoment fest

** Ziehen Sie die Schrauben von den 4 Innenschrauben ausgehend über Kreuz an (siehe Abb. 108), setzen Sie den Anzug dann mit den 4 Außenschrauben ebenfalls über Kreuz fort.

4 REPARATURWERKZEUGE

Die Wartung der Pumpe kann durch einfache Aus- und Einbauwerkzeuge erfolgen. Folgende Werkzeuge sind verfügbar:

Für den Einbau:

Ölabstreifring Kolbenführung	Art. 27910900
Ölabstreifring Ritzel	Art. 27515900
	Art. 27548200
O-Ring Druckventilsitz Versionen mit Kolben-Ø40-45-50	Art. 27516000
O-Ring Druckventilsitz Versionen mit Kolben-Ø55-60-65	Art. 27516100

Für den Ausbau:

Saugventilsitz Versionen mit Kolben-Ø40-45-50	Art. 27516200
Saugventilsitz Versionen mit Kolben-Ø55-60-65	Art. 27516300
Druckventilsitz	Art. 27516400
Ölabstreifring-Deckel	Art. 27516400
	Art. 27516500
Gruppe Buchse + Dichtungshalter	Art. 27516600
Getriebedeckel	Art. 27516700
Welle (Pleuelbefestigung)	Art. 27566200

5 AUSTAUSCH DER PLEUELAUGENBUCHSE

Führen Sie das Setzen der Buchse und die anschließenden Bearbeitungen im Kaltzustand aus und beachten Sie dabei die Maße und Toleranzen gemäß Abb. 150.



Abb. 150

6 SPEZIALVERSIONEN

Im Nachhinein finden Sie die Anweisungen zur Reparatur der Spezialversionen. Soweit nicht anders angegeben, gelten die vorstehenden Angaben für die Pumpen MK-MKS in Standardversion.

- Pumpen MKC - MKSC: für die Reparatur gelten die Anweisungen der Pumpen MK-MKS in Standardversion.
- Pumpen MKR- MKSR: für die Reparatur gelten die Anweisungen der Pumpen MK in Standardversion, mit Ausnahme der Druckdichtungen, die in folgenden Abschnitten behandelt werden.

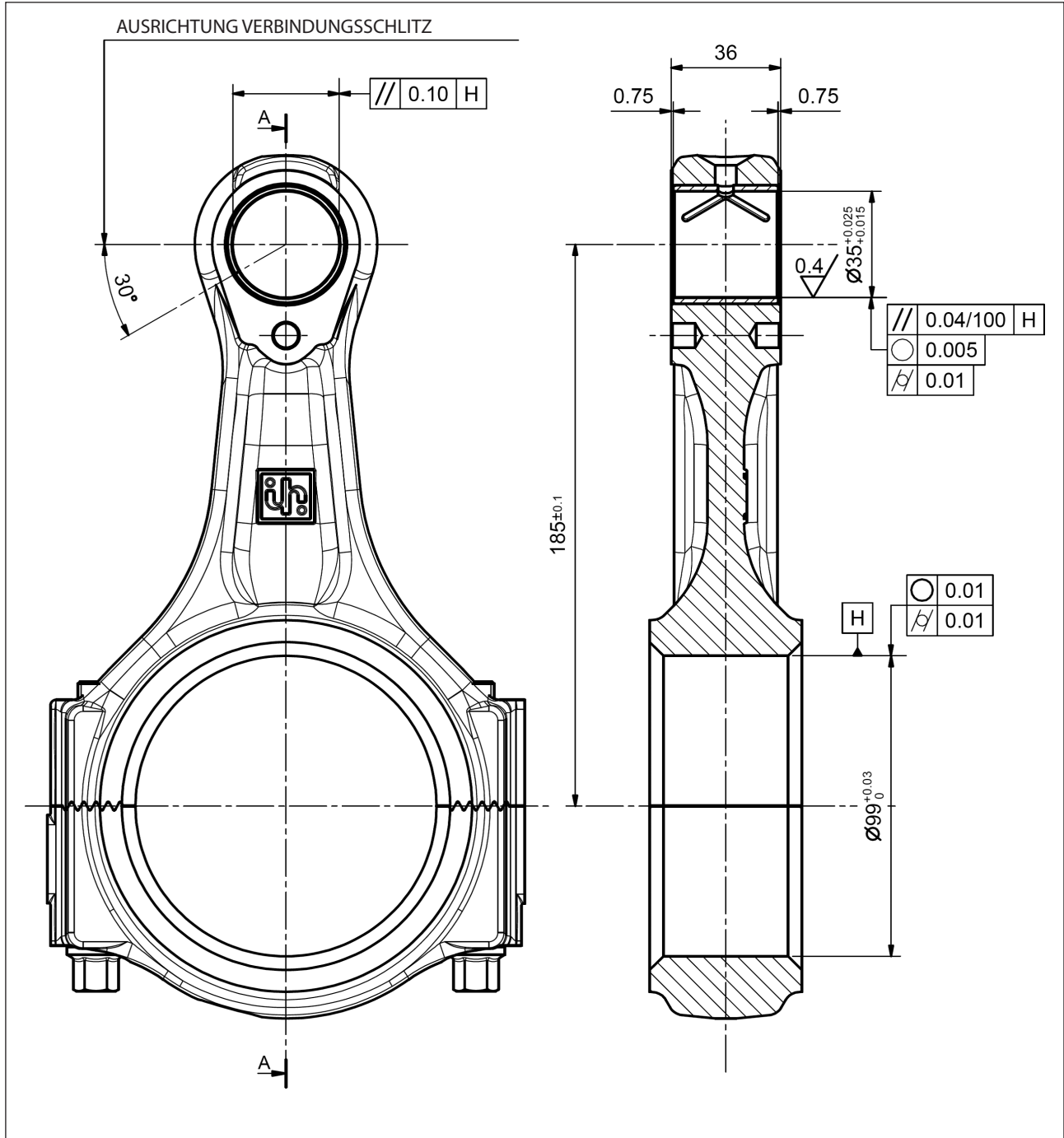
6.1 AUSBAU DER KOLBENGRUPPE - LAHER - DICHTUNGEN

Die Kolbengruppe bedarf einer regelmäßigen Prüfung lt. Angaben in der Tabelle der vorbeugenden Wartung der **Betriebs- und Wartungsanleitung**.

Die Eingriffe beschränken sich lediglich auf die Sichtprüfung der Ablassbohrung am unteren Deckel. Sollten Störungen / Schwingungen am Druckmanometer oder Tropferscheinungen aus der Ablassbohrung auftreten, muss das Dichtungspaket überprüft und ggf. ausgetauscht werden. Verfahren Sie zur Abnahme der Kolbenbaugruppen wie folgt: Lösen Sie für den Zugriff auf die Kolbengruppe die Schrauben M16x180 und bauen Sie den Kopf aus.



Ziehen Sie den Kopf mit größter Vorsicht heraus, um nicht gegen die Kolben zu stoßen.

Demontieren Sie die Kolben durch Abdrehen der Befestigungsschrauben (Pos. ①, Abb. 151). Streifen Sie den Kolben aus dem Dichtungshalter und überprüfen Sie die Kolbenoberfläche auf etwaige Kratzer, Verschleiß- oder Kavitationsanzeichen:



Abb. 151

Demontieren Sie den oberen Inspektionsdeckel durch Abdrehen der 4 Befestigungsschrauben (Pos. ①, Abb. 152).

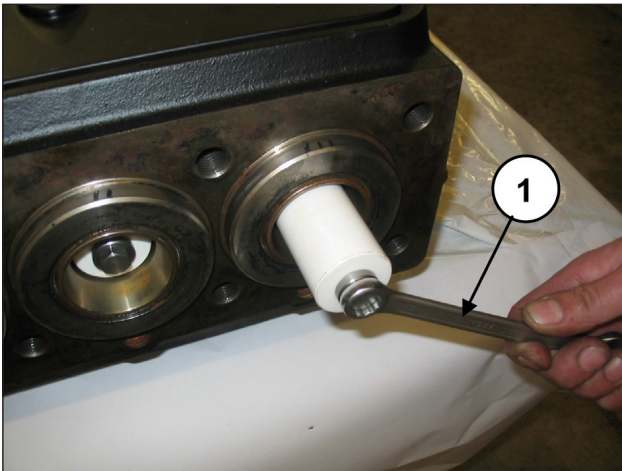

Abb. 152

Drehen Sie die Welle von Hand so, dass die 3 Kolben schrittweise an ihren oberen Totpunkt bewegt werden, und setzen Sie den Dorn Art. 27516600 zwischen Kolbenführung und Kolben ein (Pos. ①, Abb. 153).

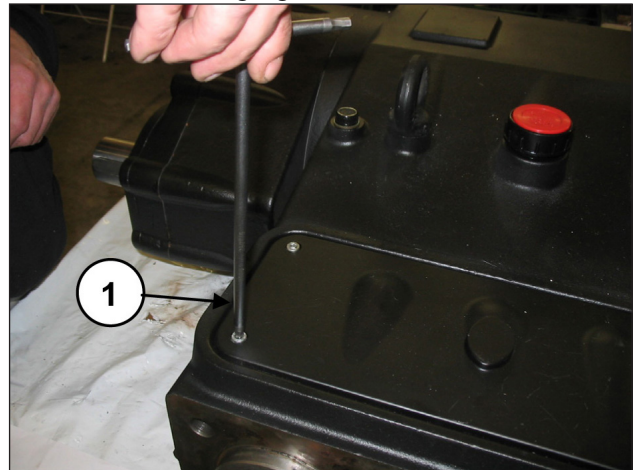

Abb. 153

Schieben Sie die Kolbenführung durch Drehen der Welle soweit vor, dass der mitgetriebene Dorn den Dichtungshalter, die Feder und die gesamte Kolbenbaugruppe herausdrückt (Pos. ①, Abb. 154).

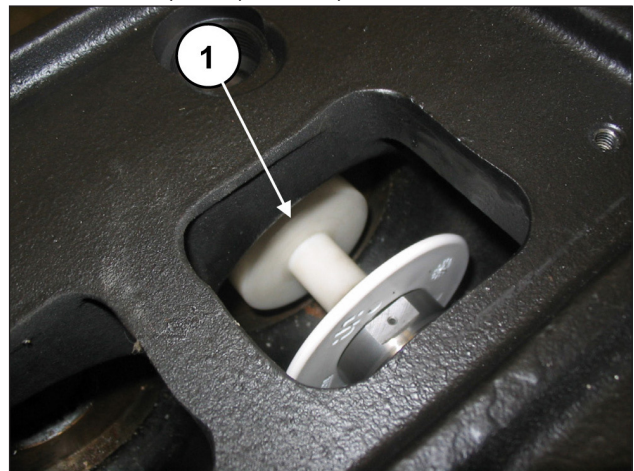

Abb. 154

Entfernen Sie den Dichtungshalter und den Dorn.

Nehmen Sie den O-Ring am Boden des Dichtungshalters ab, sollte er im Pumpengehäuse verblieben sein (Pos. ①, Abb. 155).

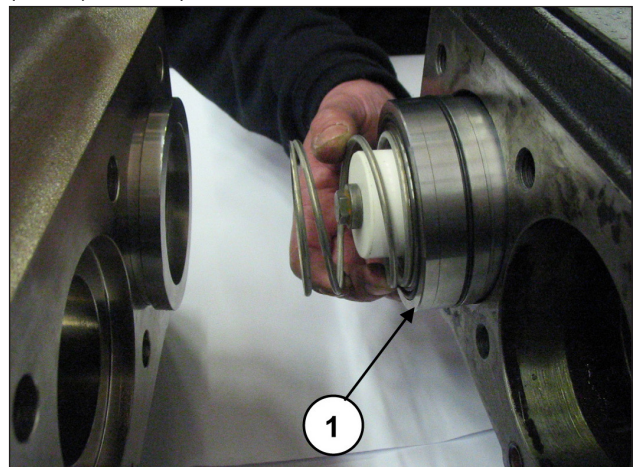

Abb. 155

Entfernen Sie die Spritzschutzringe von den Kolbenführungen (Pos. ①, Abb. 156).

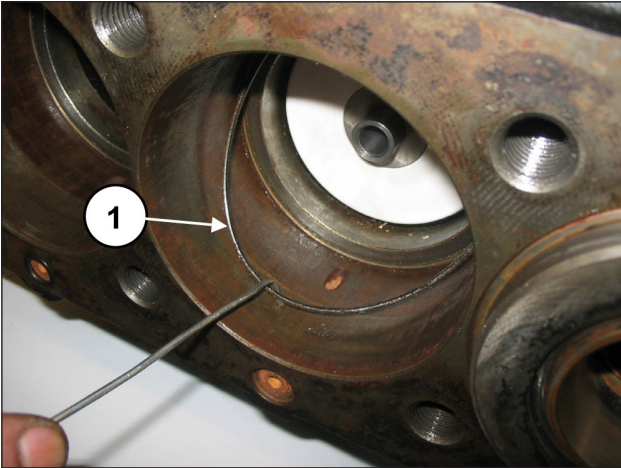

Abb. 156

Sollte der Austausch des Ölabbstreifings der Kolbenführung erforderlich sein, gehen Sie zum Ausbau des Ölabbstreifing-Deckels folgendermaßen vor:
Lösen Sie die zwei Befestigungsschrauben des Ölabbstreifing-Deckels (Pos. ①, Abb. 157).

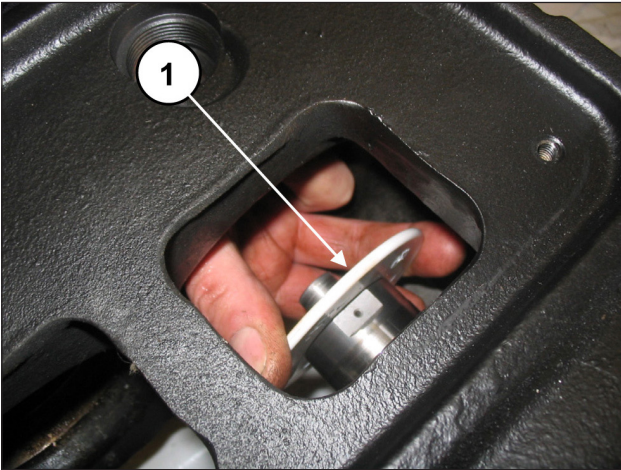

Abb. 157

Bringen Sie die Kolbenführungen auf den unteren Totpunkt, drehen Sie den Abzieher Art. 27516400 mit Adapter M5 Art. 27516500 in die entsprechenden Bohrungen am Deckel ein (Pos. ①, Abb. 158) und nehmen Sie den Ölabbstreifing-Deckel von der Pumpengruppe ab (Pos. ①, Abb. 159).



Abb. 158

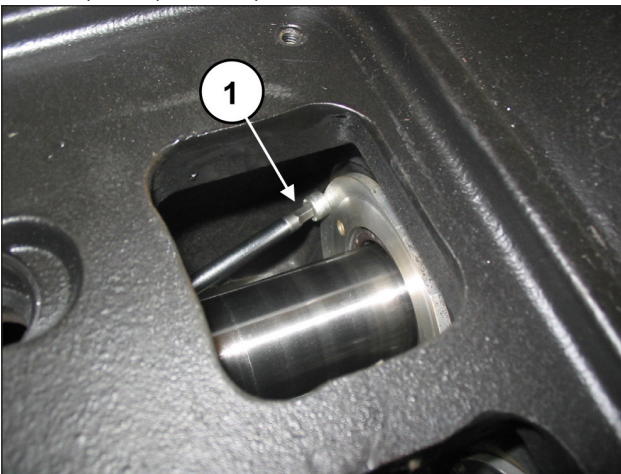

Abb. 159

Ersetzen Sie den Ölabbstreifing (Pos. ①, Abb. 160) und den äußeren O-Ring (Pos. ②, Abb. 160).

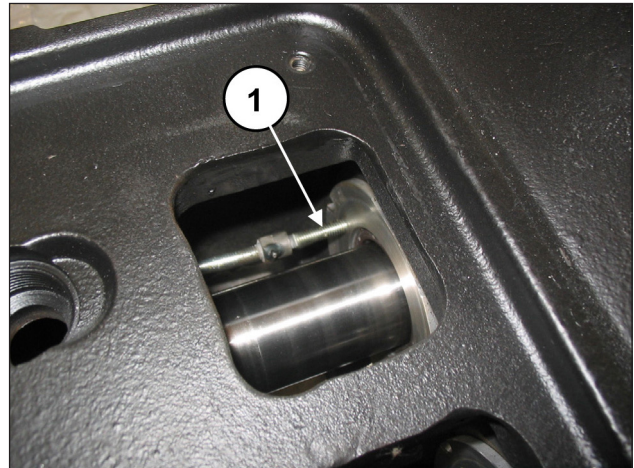

Abb. 160

Trennen Sie den Dichtungshalter von der Buchse, entfernen Sie dann den Federring und den Abstreifring (Pos. ①②, Abb. 161), um die Druckdichtungen freizulegen (Pos. ①, Abb. 162).



Abb. 161

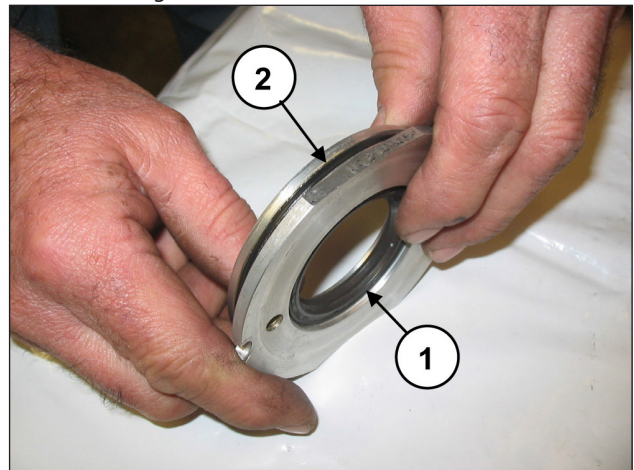

Abb. 162

Zur Abnahme der ND-Dichtung müssen Sie eine Fühlerlehre oder ein ähnliches Werkzeug verwenden, das den Sitz des Dichtungshalters nicht beschädigt (Pos. ①, Abb. 163).

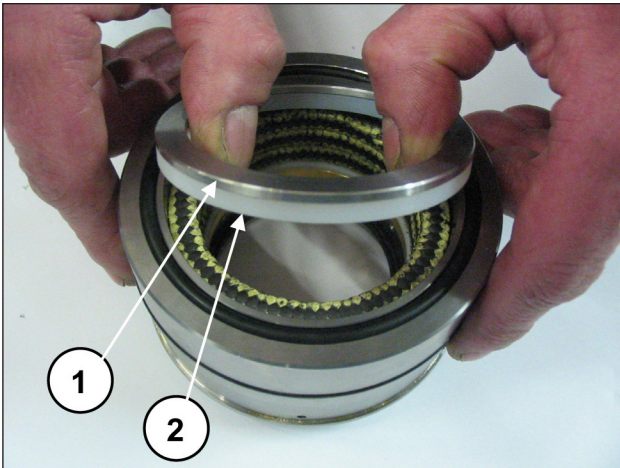

Abb. 163

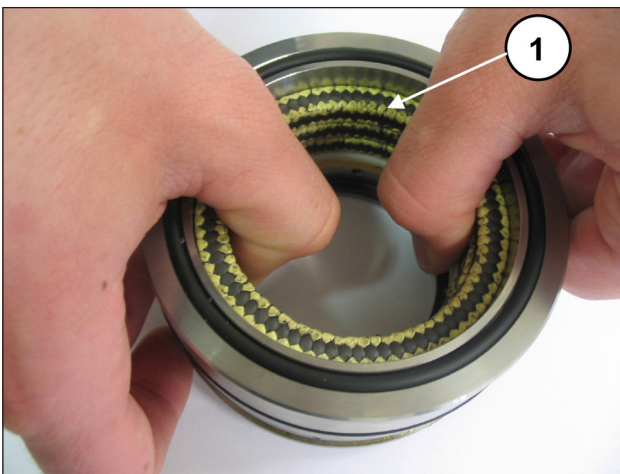
6.2 EINBAU DER KOLBENGRUPPE - LAGER - DICHTUNGEN

Verfahren Sie für den Wiedereinbau in umgekehrter Ausbaureihenfolge zu den Angaben in Abschn. 6.1.

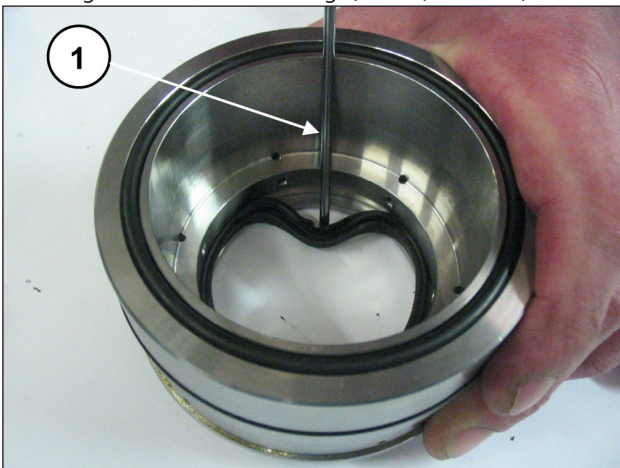

Ersetzen Sie die Druckdichtungen, indem Sie die Dichtlippen mit Silikonfett befeuchten (nicht bestreichen). Achten Sie besonders darauf, die Dichtungen beim Einsetzen in die Buchse nicht zu beschädigen.



Bei jedem Ausbau müssen die Druckdichtungen mit sämtlichen O-Ringen ersetzt werden.

Setzen Sie die ND-Dichtung in den Halter der Stopfbuchse ein (Pos. ①, Abb. 164) und achten Sie hierbei auf die Einbaurichtung mit nach vorn gerichteter Dichtlippe (zum Kopf hin) und auf den O-Ring (Pos. ②, Abb. 164).



Abb. 164

Montieren Sie den Lagerring und den Stützring (Pos. ①②, Abb. 165) sowie die drei Stopfbuchsen, achten Sie dabei, dass die Schlitz in einem Winkel von 120° zueinander ausgerichtet sind (Pos. ①, Abb. 166), darüber hinaus den Abstreifring der Stopfbuchsen und den Federring (Pos. ①②, Abb. 167).



Abb. 165

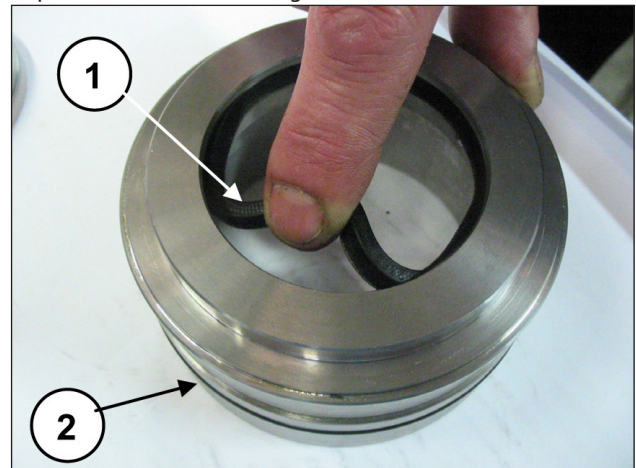

Abb. 166

Montieren Sie den Ölabbstreifring in seinen Deckel (Pos. ①, Abb. 169) mithilfe eines Dorns Art. 27910900.

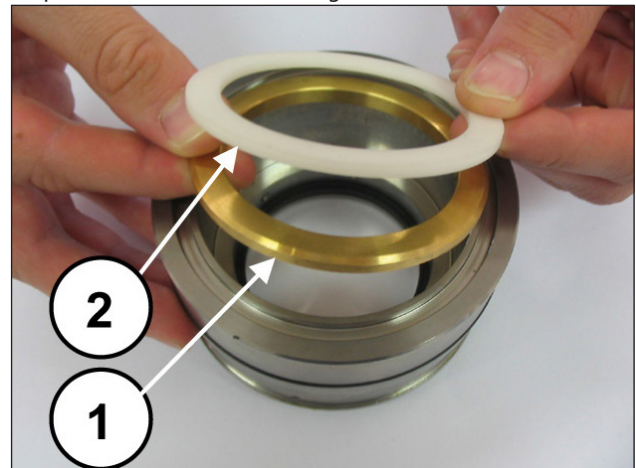

Abb. 169

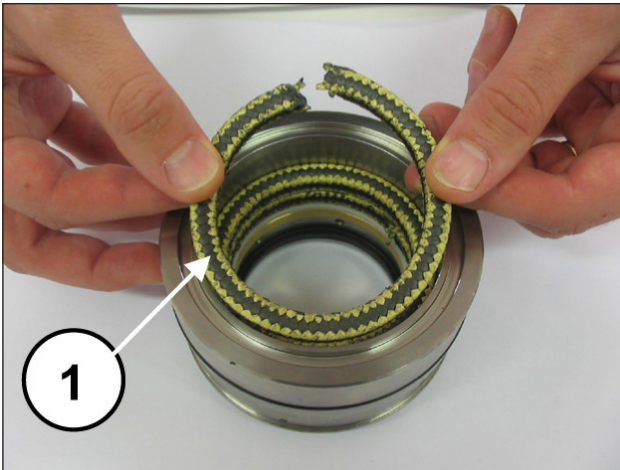

Abb. 167

Setzen Sie den O-Ring (Pos. ①, Abb. 170) in die Aufnahme des Ölabbstreifring-Deckels ein und bringen Sie die montierte Gruppe in den Gehäusesitz an (Pos. ①, Abb. 171).

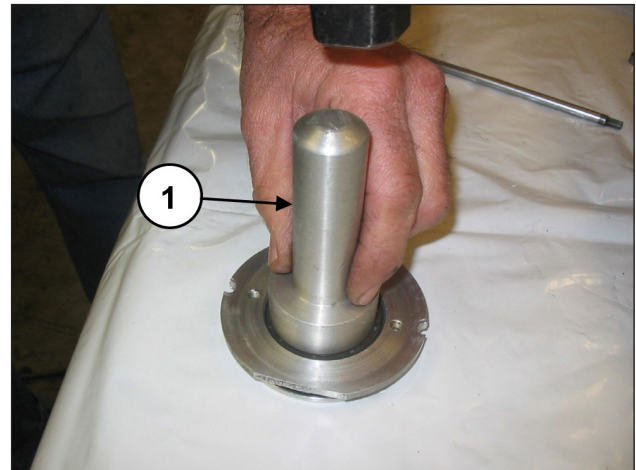

Abb. 170

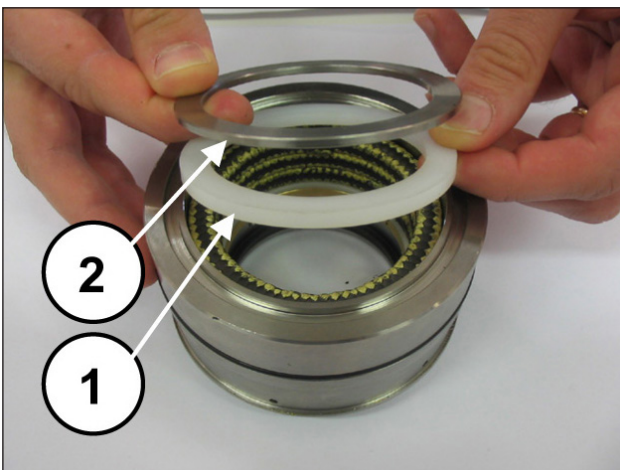
Montieren Sie nun den Kopfring der Stopfbuchsen samt O-Ring (Pos. ①, Abb. 168) und setzen Sie diesen in den Sitz am Kopf ein.



Abb. 168

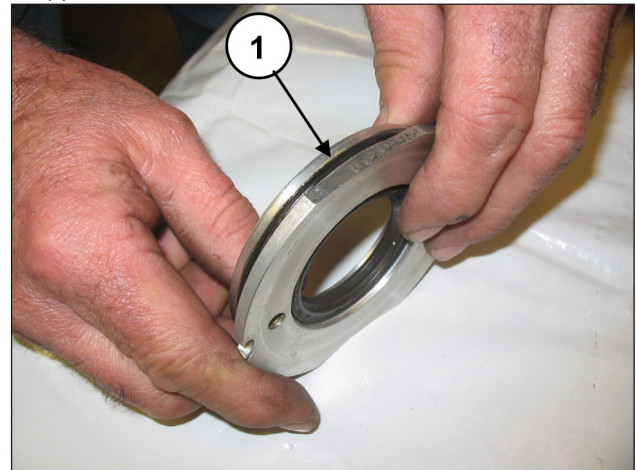

Abb. 171

Überprüfen Sie den passgerechten Sitz des Deckels (Pos. ①, Abb. 172) und achten Sie darauf, nicht die Dichtlippe des Ölabbstreifings zu beschädigen. Befestigen Sie die Ölabbstreifring-Deckel anhand von 2 Schrauben M6x14 (Pos. ①, Abb. 173).

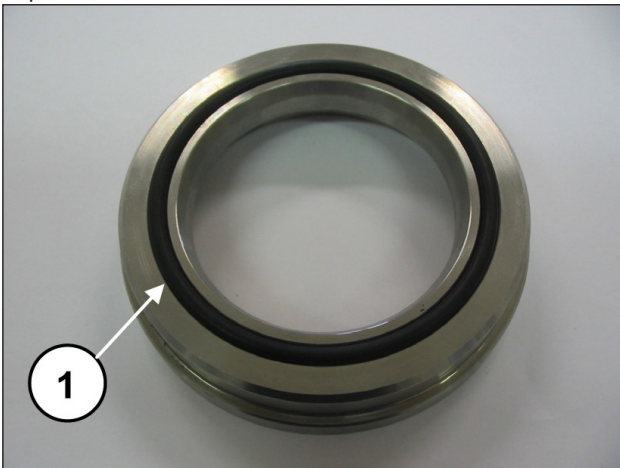

Abb. 172

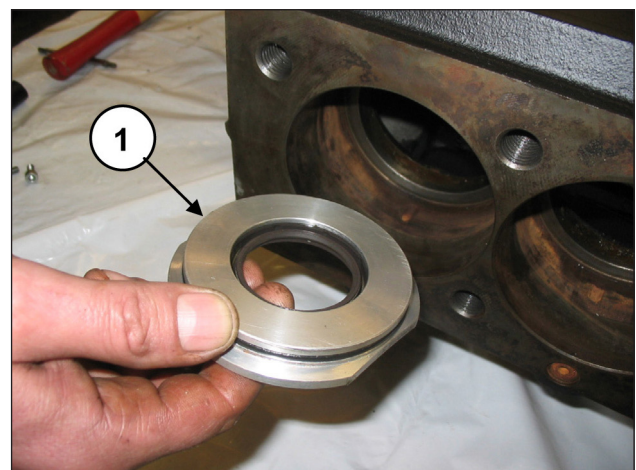

Abb. 173

Eichen Sie die Schrauben mit einem Drehmomentschlüssel, wie in Kapitel 3 gezeigt. Montieren Sie den Spritzschutz samt O-Ring in die Aufnahme an der Kolbenführung (Pos. ①, Abb. 174 und Abb. 175).

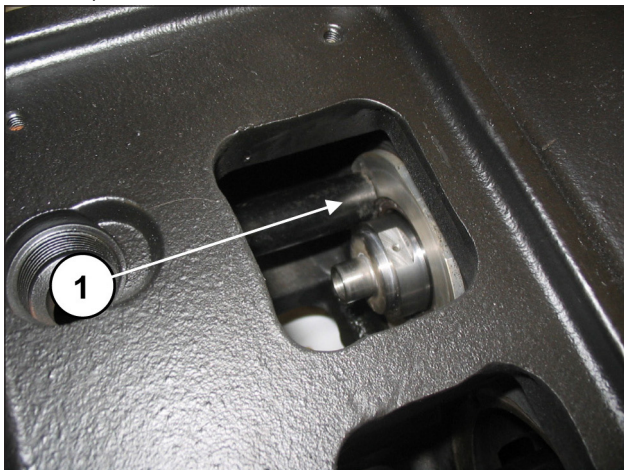

Abb. 174

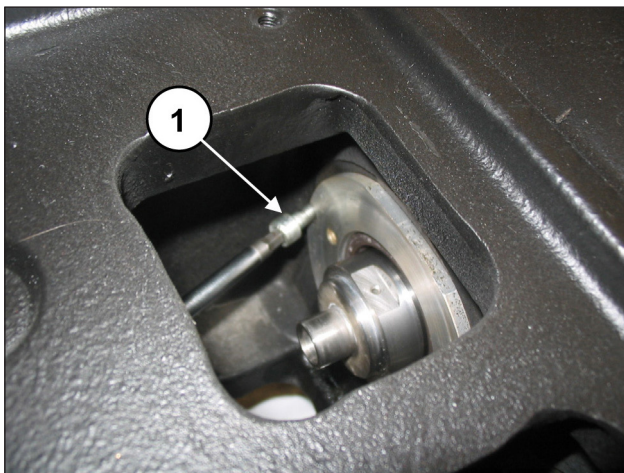

Abb. 175

Setzen Sie die Unterlegscheibe $\text{\O}10 \times 18 \times 0,9$ auf die Befestigungsschraube des Kolbens (Pos. ①, Abb. 176).

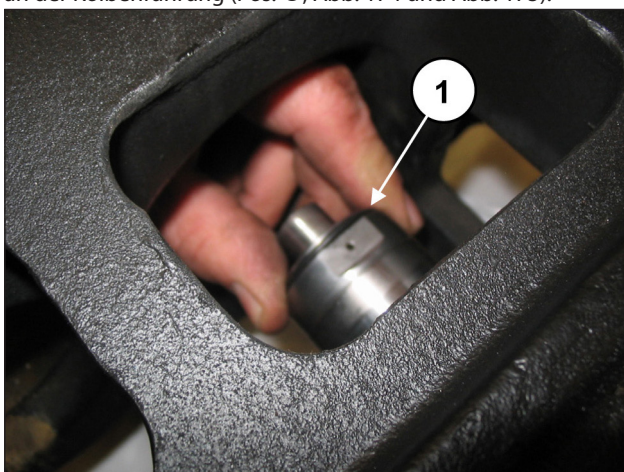

Abb. 176

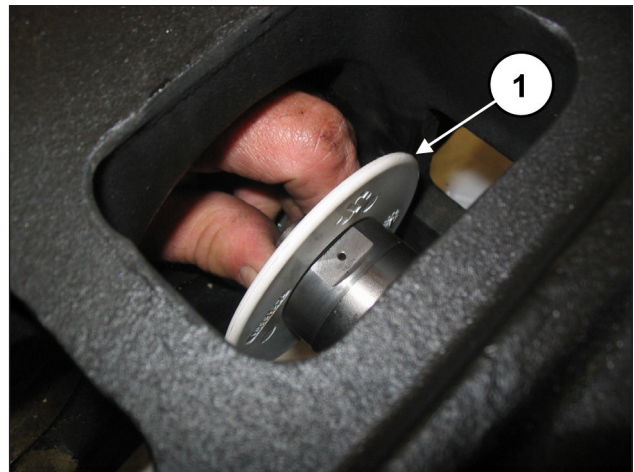
Montieren Sie die Kolben in die entsprechenden Führungen (Pos. ①, Abb. 177) und befestigen Sie diese lt. Pos. ①, Abb. 178.



Abb. 177

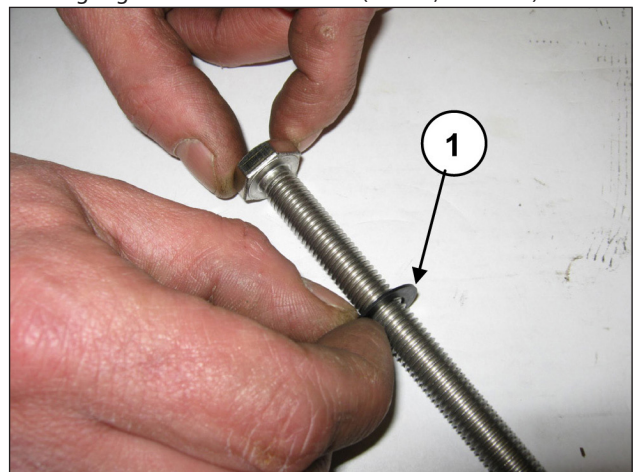

Abb. 178

Eichen Sie die Schrauben mit einem Drehmomentschlüssel, wie in Kapitel 3 gezeigt.

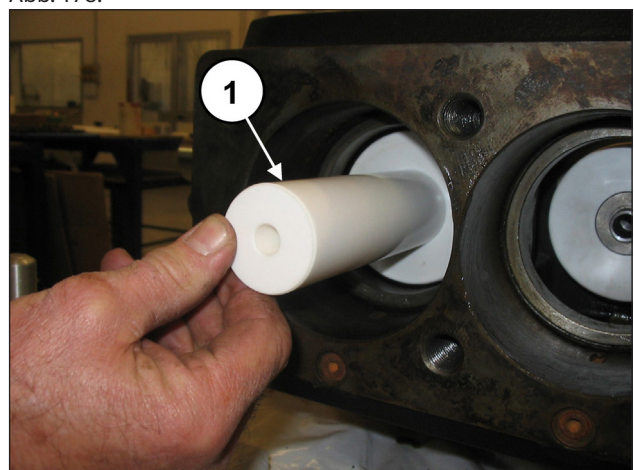
Montieren Sie den O-Ring in das Pumpengehäuse (Pos. ①, Abb. 179) und anschließend die vorab zusammengebaute Gruppe Buchse-Dichtungshalter (mitsamt O-Ring) bis auf Anschlag (Pos. ①, Abb. 180).

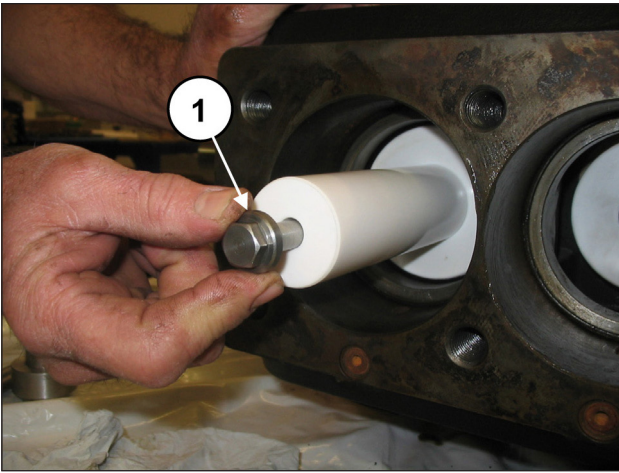

Abb. 179



Abb. 180

Vergewissern Sie sich, dass die Gruppe Buchse-Dichtungshalter bündig in ihrem Sitz liegt (Pos. ①, Abb. 181); montieren Sie nun den frontseitigen O-Ring der Buchse sowie die Feder (Pos. ①②, Abb. 182).

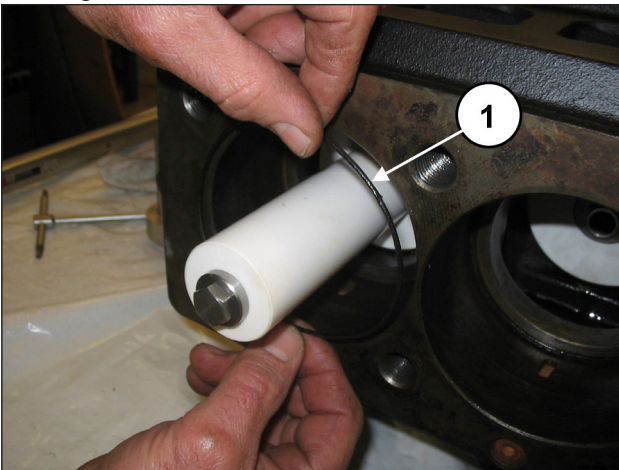

Abb. 181

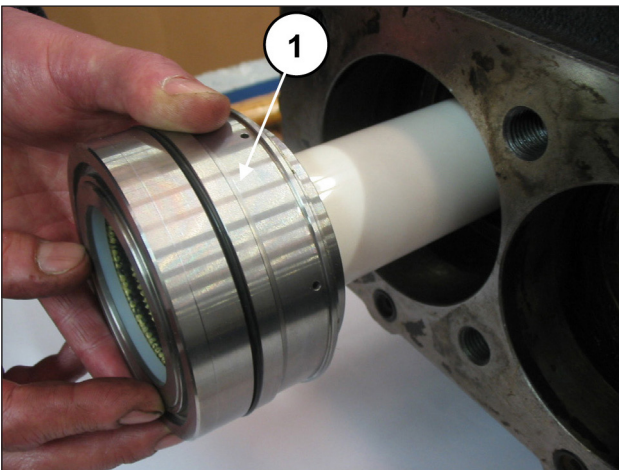

Abb. 182

Setzen Sie den O-Ring an der Umlaufbohrung ein (Pos. ①, Abb. 183).

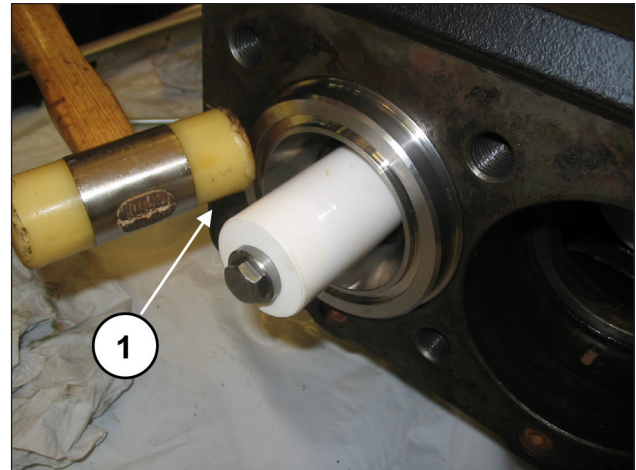
Erleichtern Sie den passgerechten Sitz der O-Ringe, indem Sie etwas Fett auftragen.

In Abb. 184 ist der anschließende Einbau des Kopfs dargestellt.

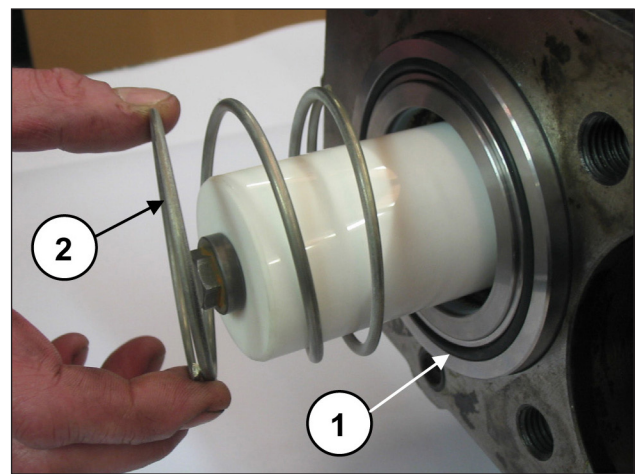

Abb. 183



Abb. 184

Setzen Sie auf die Inspektionsdeckel den O-Ring (Pos. ①, Abb. 185) und montieren Sie die Deckel anhand von 4+4 Schrauben M6x14 (Pos. ①, Abb. 186).

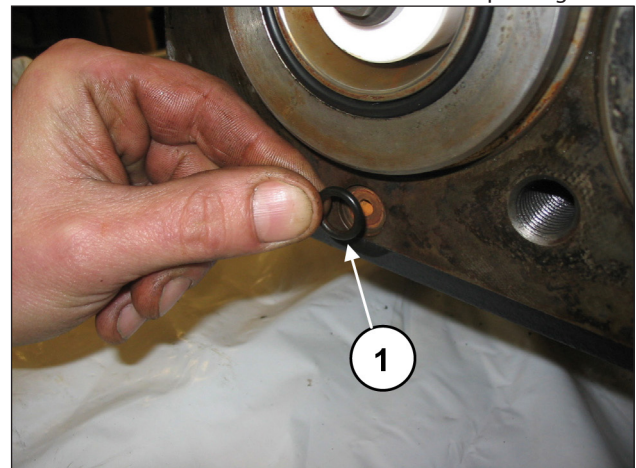

Abb. 185

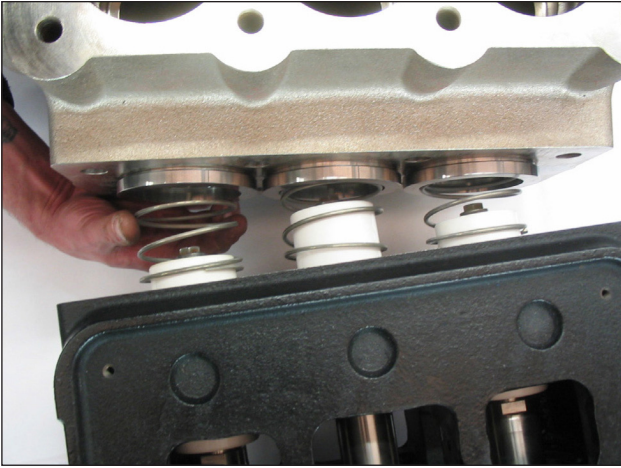

Abb. 186

Eichen Sie die Schrauben mit einem Drehmomentschlüssel, wie in Kapitel 3 gezeigt.

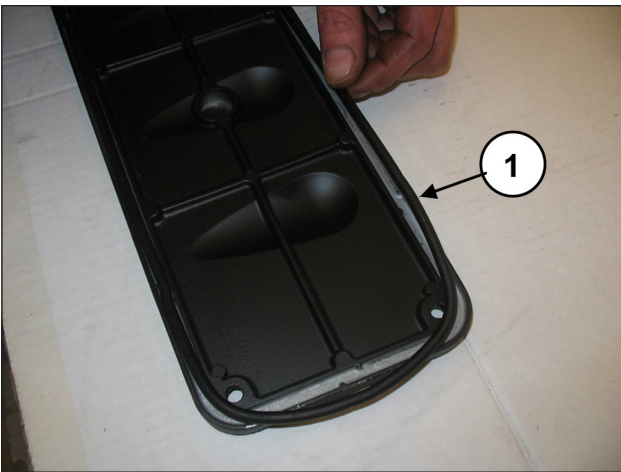
Índice

1	INTRODUCCIÓN	154
1.1	DESCRIPCIÓN DE LOS SÍMBOLOS	154
2	DECLARACIÓN DE REPARACIÓN	154
2.1	REPARACIÓN DE LA PARTE MECÁNICA	154
2.1.1	<i>Desmontaje de la parte mecánica</i>	154
2.1.2	<i>Montaje de la parte mecánica</i>	161
2.1.3	<i>Clases de mayoraciones previstas</i>	168
2.2	REPARACIÓN DE LA PARTE HIDRÁULICA	168
2.2.1	<i>Desmontaje de la cabeza - grupos de válvulas</i>	168
2.2.2	<i>Montaje de cabeza – grupos de válvulas</i>	170
2.2.3	<i>Desmontaje del grupo pistón - soportes - juntas</i>	174
2.2.4	<i>Montaje del grupo pistón - soportes - juntas</i>	176
2.2.5	<i>Recuperación de cabezas</i>	180
3	CALIBRACIÓN DE AJUSTE DE LOS TORNILLOS	181
4	HERRAMIENTAS DE REPARACIÓN	182
5	SUSTITUCIÓN DEL CASQUILLO PIE DE LA BIELA	183
6	VERSIONES ESPECIALES	184
6.1	DESMONTAJE DEL GRUPO PISTÓN - SOPORTES - JUNTAS	184
6.2	MONTAJE DEL GRUPO PISTÓN - SOPORTES - JUNTAS	186

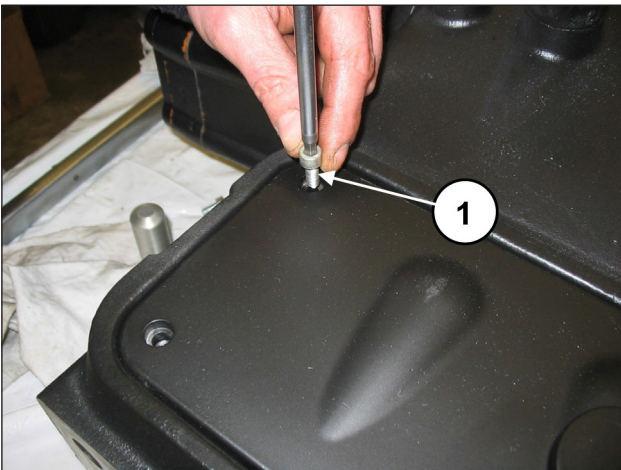
1 INTRODUCCIÓN

Este manual describe las instrucciones para la reparación de las bombas MK y debe ser atentamente leído y comprendido antes de utilizar la bomba.

De un correcto uso y un mantenimiento adecuado depende el funcionamiento regular y la duración de la bomba.

Interpump Group no se responsabiliza de los daños causados por negligencia o falta de observación de las normas descritas sobre el presente manual.

1.1 DESCRIPCIÓN DE LOS SÍMBOLOS

Leer atentamente lo indicado en el presente manual antes de realizar cada operación.



Señal de advertencia



Leer atentamente lo indicado en el presente manual antes de realizar cada operación.



Señal de Peligro

Utilizar gafas de protección



Señal de Peligro

Utilizar guantes de protección para realizar cualquier tipo de operación

2 DECLARACIÓN DE REPARACIÓN



2.1 REPARACIÓN DE LA PARTE MECÁNICA

Las operaciones de reparación de la parte mecánica deben ser realizadas después de haber retirado todo el aceite del cárter. Para eliminar el aceite es necesario quitar el tapón de llenado de aceite pos. ①, Fig. 1 y a continuación el tapón de descarga pos. ②, Fig. 1.

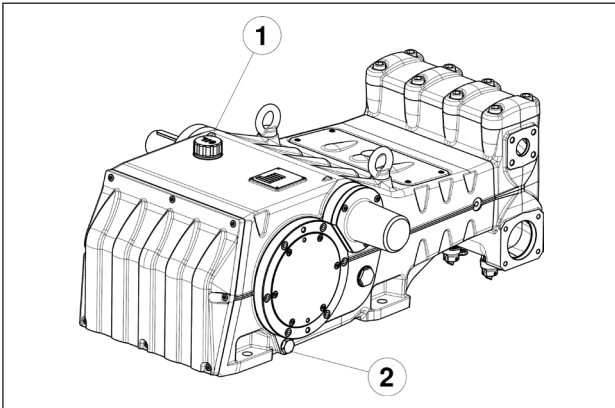

Fig. 1



El aceite agotado debe ser colocado en un recipiente adecuado y eliminado en los correspondientes centros. No debe dispersarse en el ambiente.

2.1.1 Desmontaje de la parte mecánica

La secuencia correcta es la siguiente:

Vaciar el aceite contenido en la bomba y quitar la lengüeta del eje (pos. ①, Fig. 2).



Fig. 2

Aflojar los tornillos de fijación de la brida del reductor (pos. ①, Fig. 3) y extraer la brida del eje.

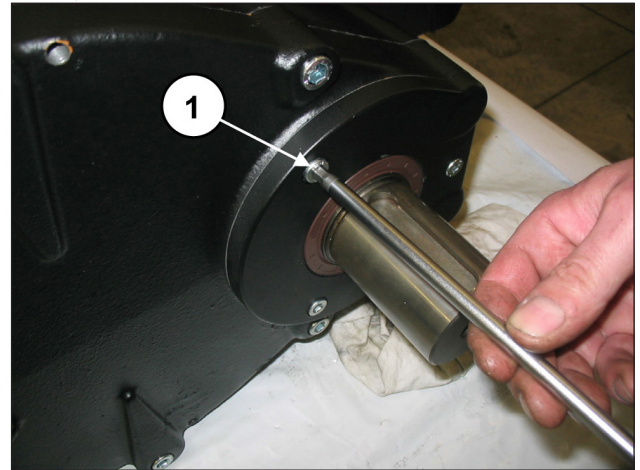

Fig. 3

En la parte opuesta, extraer los tornillos de fijación de la tapa del cojinete (pos. ①, Fig. 4) y desmontarlo.

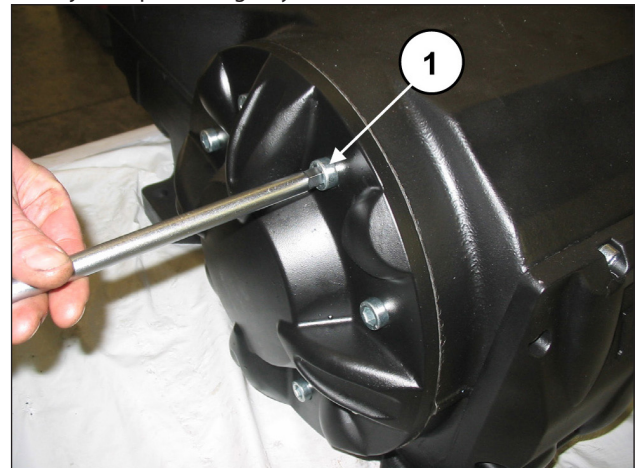

Fig. 4

Desmontar la tapa del cárter aflojando los tornillos (pos. ①, Fig. 5).

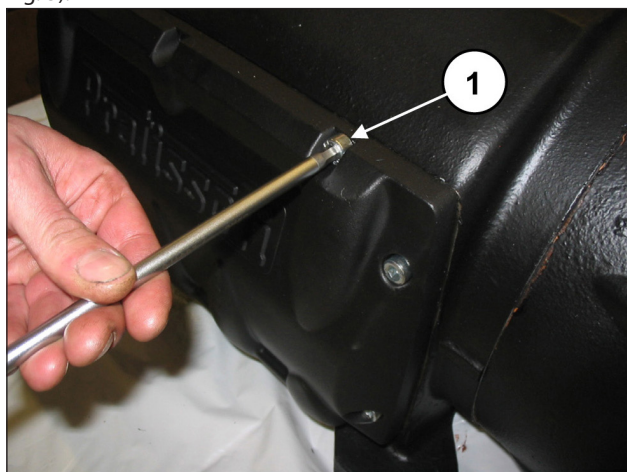

Fig. 5

Aflojar los tornillos de fijación de la tapa del reductor (pos. ①, Fig. 6).

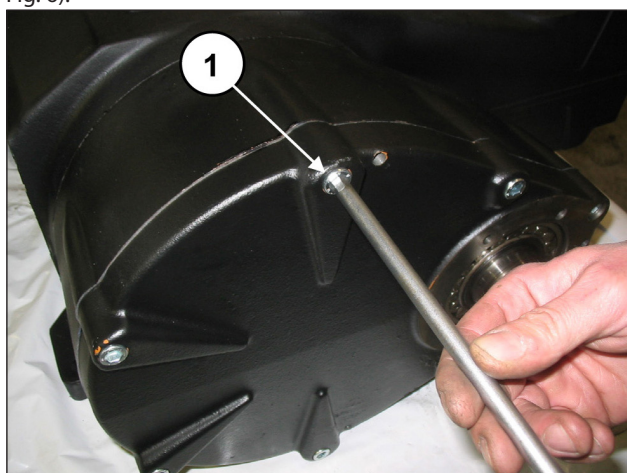

Fig. 6

Enrosca en los orificios específicos 3 tornillos prisioneros o tornillos roscados M8 (pos. ①, Fig. 7) para que actúen de extractores y 2 tornillos M10 lo suficientemente largos como para sujetar la tapa (pos. ②, Fig. 7).



Fig. 7

Apretar los 3 tornillos prisioneros roscados (pos. ①, Fig. 8) que actúan como extractores, aplicar la herramienta (cód. 27516700) y golpear sobre ella para que el cojinete no se salga del piñón al extraer la tapa (pos. ①, Fig. 9).

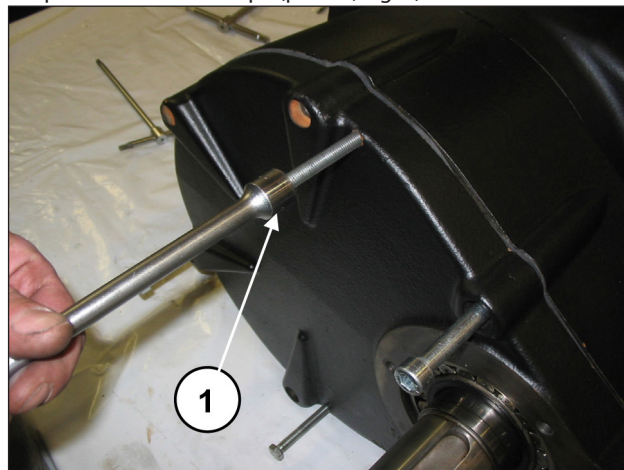

Fig. 8

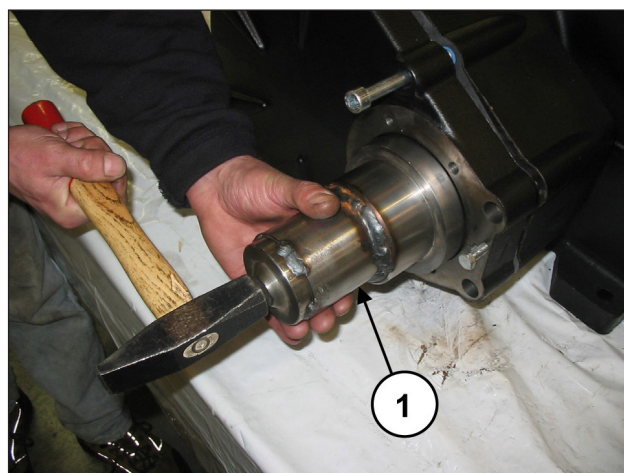

Fig. 9

Al terminar la operación, desmontar la tapa del reductor y extraer el cojinete del piñón.

Aflojar los tornillos que fijan el tope de la corona (pos. ①, Fig. 10) y desmontarlo (pos. ①, Fig. 11).

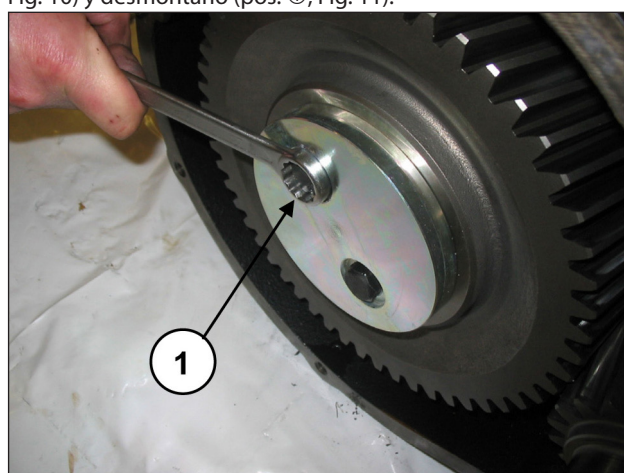

Fig. 10

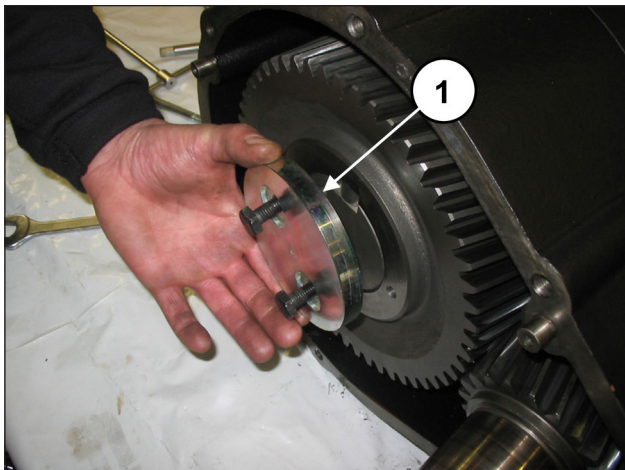

Fig. 11

Quitar la corona (pos. ①, Fig. 12). Si es necesario, aplicar un extractor de percusión en los 2 orificios M8 (, pos. ②, Fig. 12).

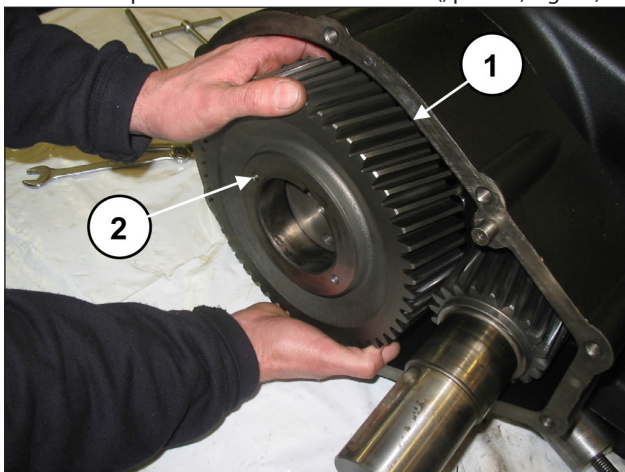

Fig. 12

Quitar la lengüeta del eje PTO (pos. ①, Fig. 13).

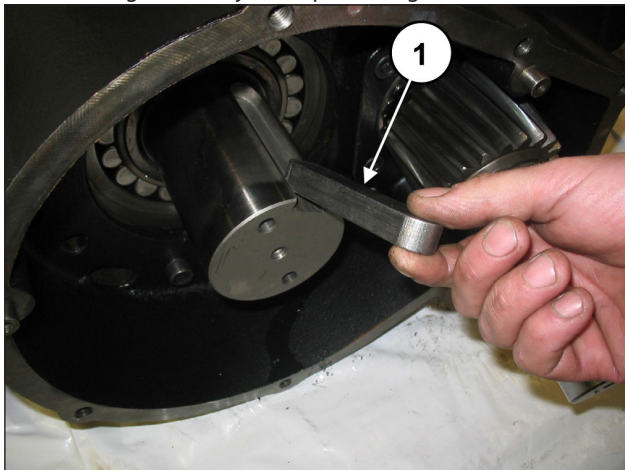

Fig. 13

Desmontar el piñón colocando un extractor de percusión en el orificio M14 (pos. ①, Fig. 14).

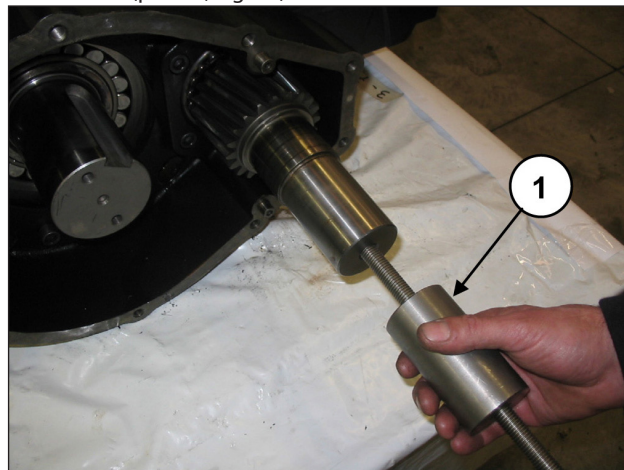

Fig. 14

Levantar la lengüeta de la arandela de seguridad (pos. ①, Fig. 15).

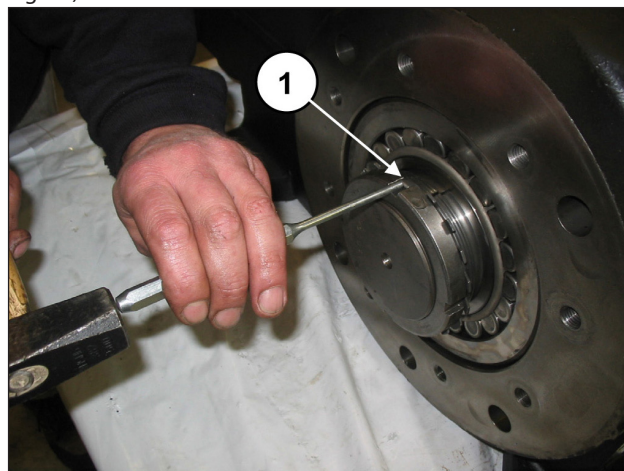

Fig. 15

Introducir un espesor debajo de la biela para bloquear la rotación del eje (pos. ①, Fig. 16).

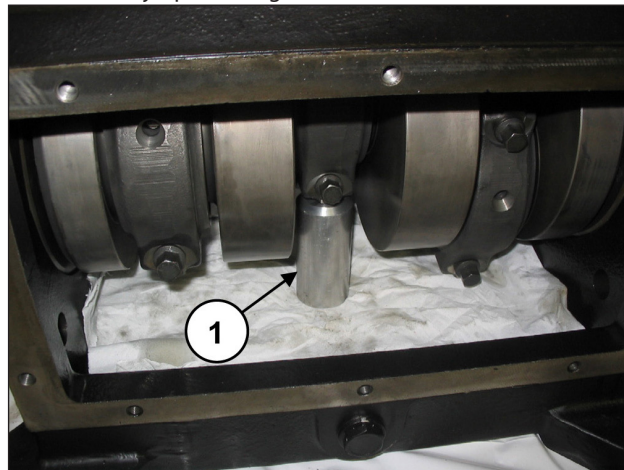

Fig. 16

Utilizando una llave adecuada, desenroscar la corona de bloqueo (pos. ①, Fig. 17). A continuación, quitar la corona y la arandela de seguridad (pos. ①, Fig. 18).

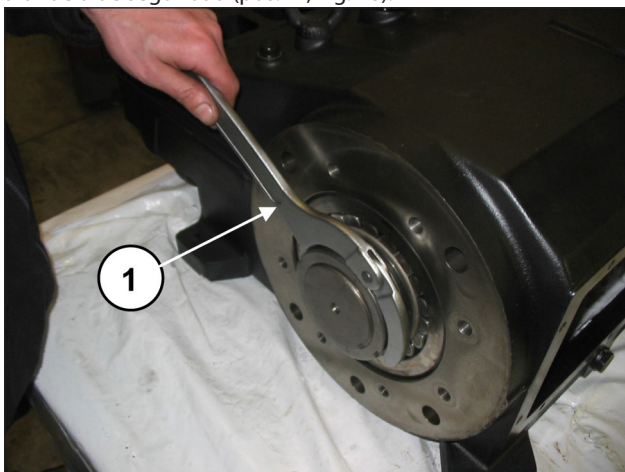

Fig. 17

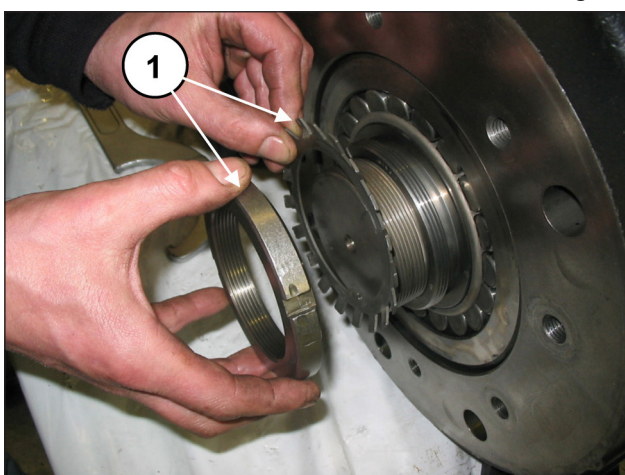

Fig. 18

Enroscar una corona de tipo SKF KM19 en el casquillo de presión (pos. ①, Fig. 19) y, utilizando una llave adecuada, aflojar el casquillo (pos. ①, Fig. 20).

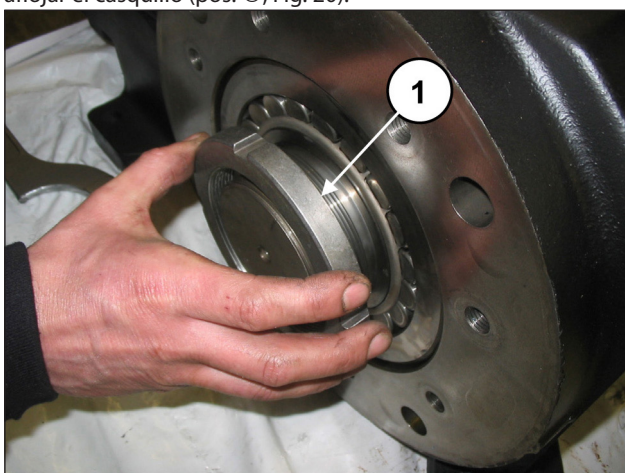

Fig. 19

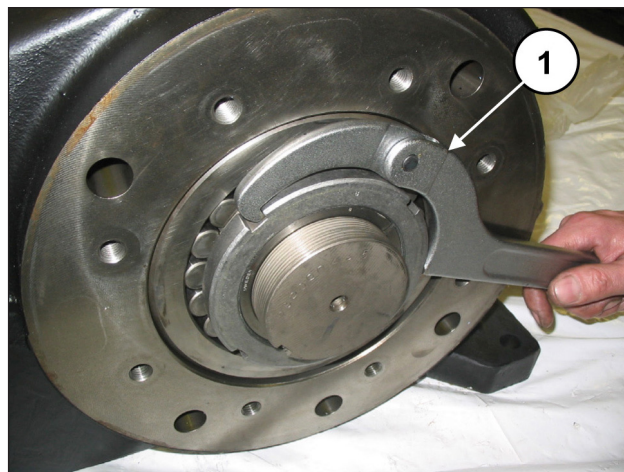

Fig. 20

En el lado opuesto, aflojar los tornillos de fijación de la caja del reductor (pos. ①, Fig. 21) y desmontarla (pos. ①, Fig. 22).

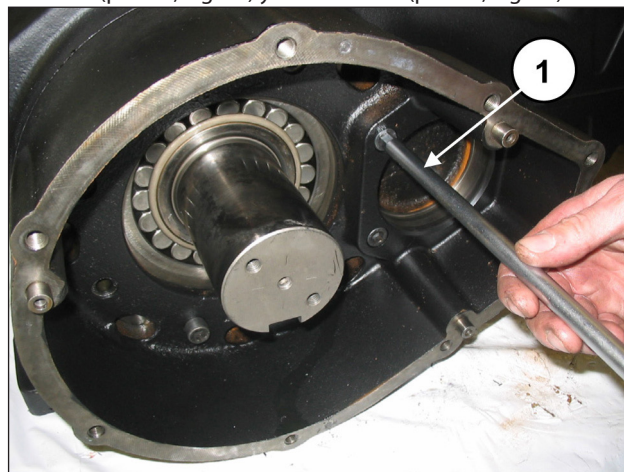

Fig. 21

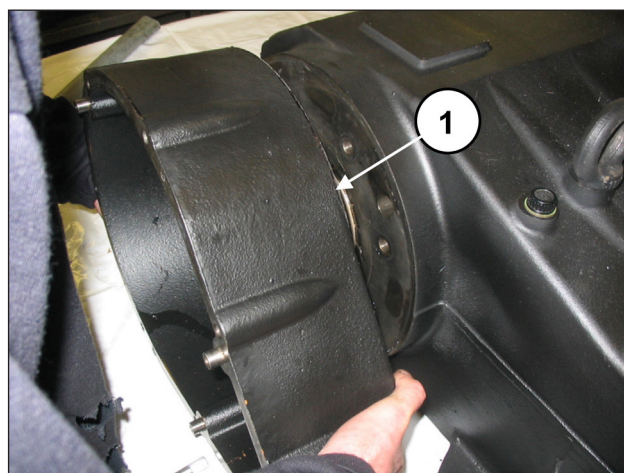

Fig. 22

Aflojar los tornillos de la biela (pos. ①, Fig. 23).

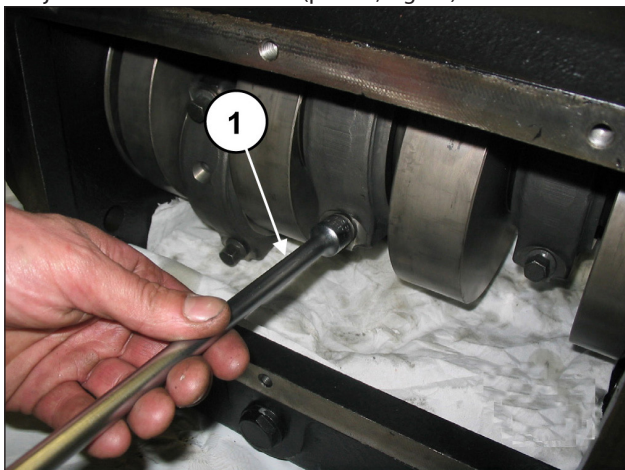

Fig. 23

Desmontar los sombreretes de la biela con los semicojinetes, controlando el orden de desmontaje.



Al montar los sombreretes de la biela y sus semibielas se deben respetar el orden y el emparejamiento de desmontaje.

Para evitar posibles errores, sombreretes y semibielas han sido enumerados en un lateral (pos. ①, Fig. 24).

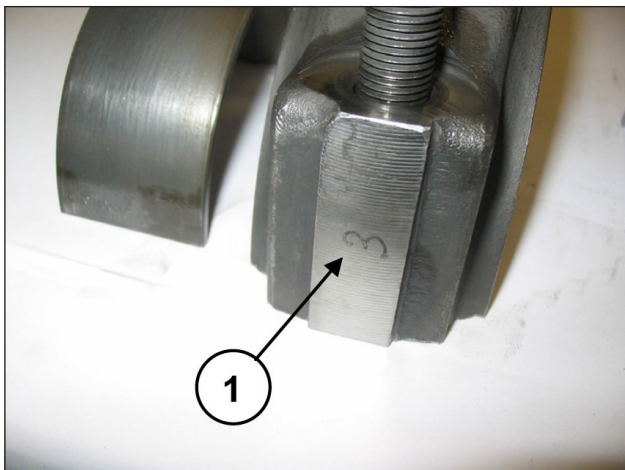

Fig. 24

Desplazar las semibielas hacia la parte hidráulica para extraer el eje. Para facilitar la operación, utilizar la herramienta específica (cód. 27566200), (pos. ①, Fig. 25).

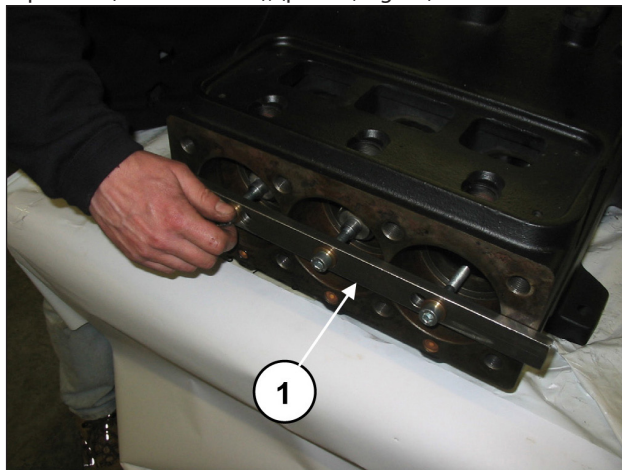

Fig. 25

Desmontar el casquillo de presión (pos. ①, Fig. 26).

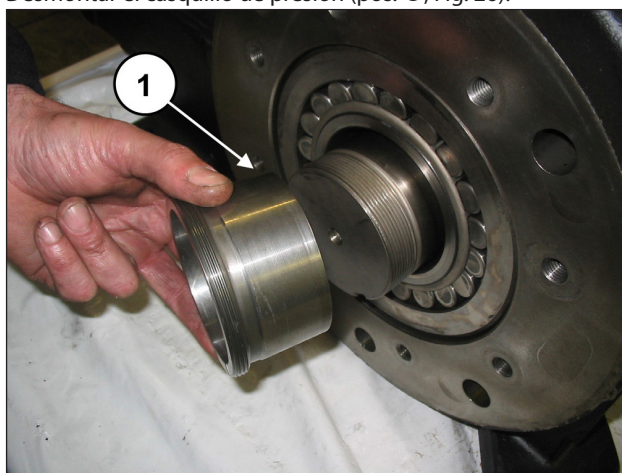

Fig. 26

Extraer los 3 semicojinetes superiores de las semibielas (pos. ①, Fig. 27).

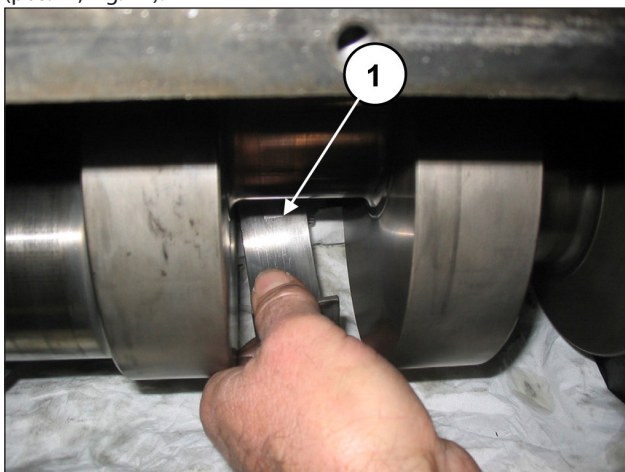

Fig. 27

Extraer el eje acodado con una herramienta de percusión, desde el lado PTO (pos. ①, Fig. 28).

Extraer el eje y el cojinete (pos. ①, Fig. 29).

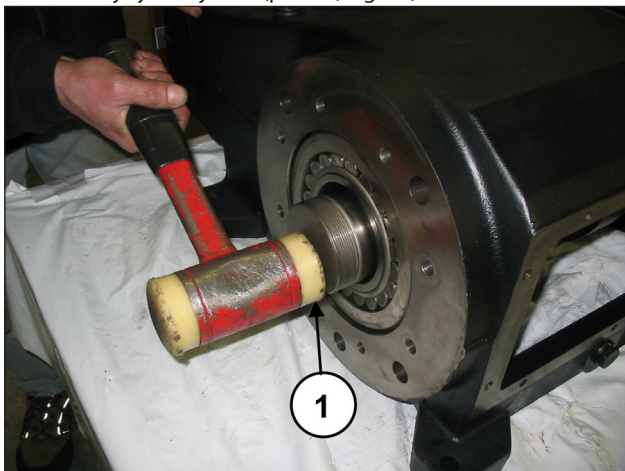

Fig. 28

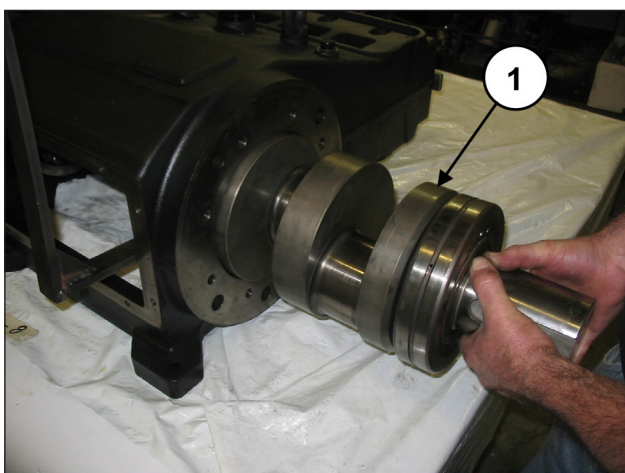

Fig. 29

Desde la parte opuesta, extraer el cojinete (pos. ①, Fig. 30).

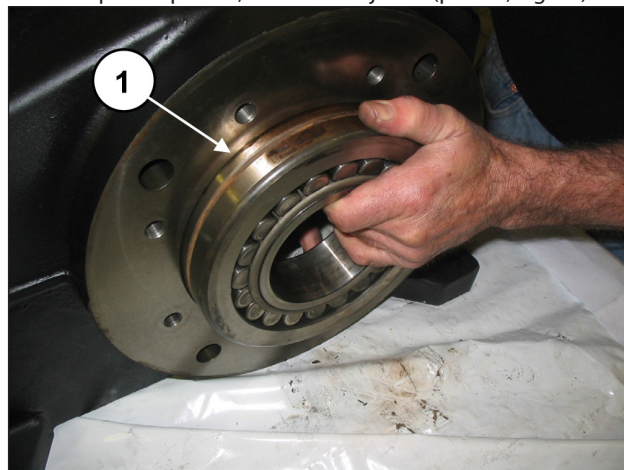

Fig. 30

En aquellos casos en los que sea necesario sustituir una o más bielas, o guías del pistón, actuar del siguiente modo: Aflojar los tornillos de la herramienta cód. 27566200 para desbloquear las bielas (pos. ①, Fig. 31) y, a continuación, extraer los grupos biela-guía del pistón por la abertura posterior del cárter (pos. ①, Fig. 32).

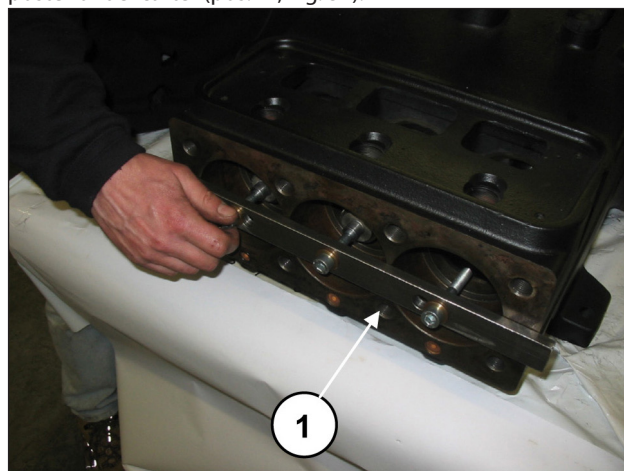

Fig. 31

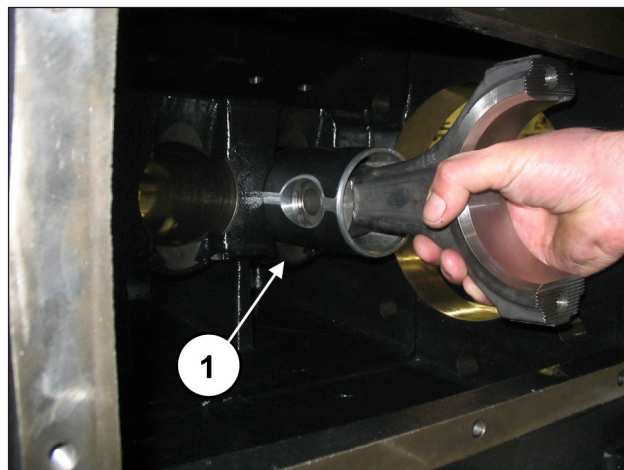

Fig. 32

Acoplar las semibielas en los sombreretes ya desmontados, controlando la numeración (pos. ①, Fig. 33).

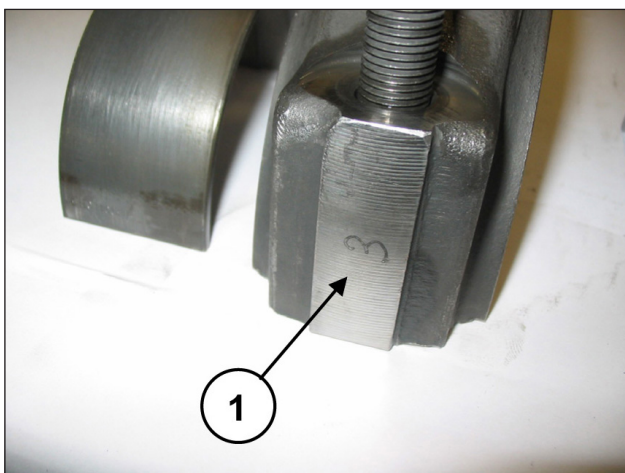

Fig. 33

Desmontar las 2 anillas seeger de bloqueo de la clavija utilizando la herramienta específica (pos. ①, Fig. 34).

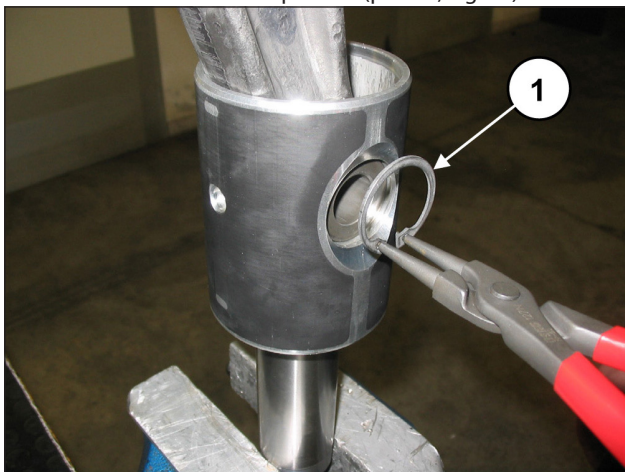

Fig. 34

Extraer la clavija (pos. ①, Fig. 35) y, a continuación, la biela (pos. ①, Fig. 36).



Fig. 35

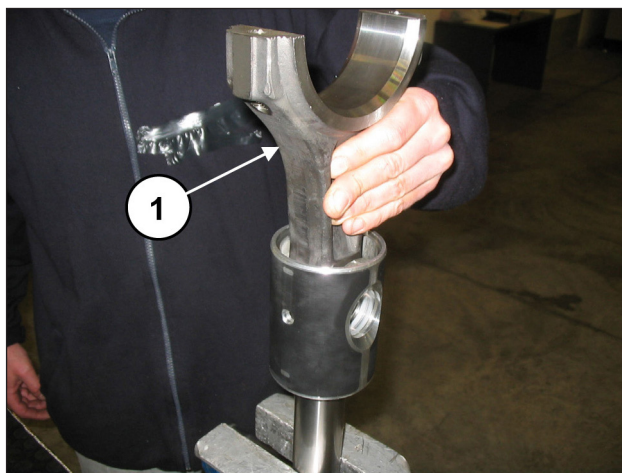

Fig. 36

Para separar el vástago de la guía del pistón, es necesario aflojar los tornillos de cabeza cilíndrica M6 con la llave específica (pos. ①, Fig. 37).

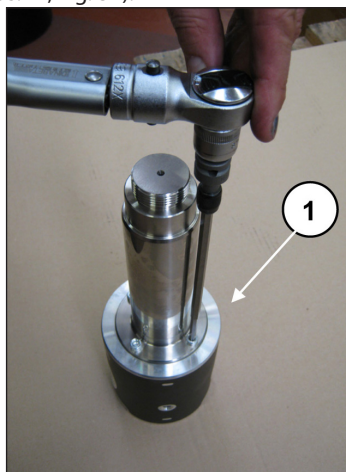

Fig. 37

2.1.2 Montaje de la parte mecánica

Seguir en orden contrario la secuencia de desmontaje descrita en el apart. 2.1.1.

La secuencia correcta es la siguiente:

Ensamblar el vástago en la guía del pistón.

Introducir el vástago de guía del pistón en el alojamiento de la guía del pistón (pos. ①, Fig. 38) y fijarlo con los 4 tornillos de cabeza cilíndrica M6x20 (pos. ①, Fig. 39).



Fig. 38



Fig. 39

Bloquear la guía del pistón con la herramienta específica y apretar los tornillos con la llave dinamométrica (pos. ①, Fig. 40) como se indica en el capítulo 3.

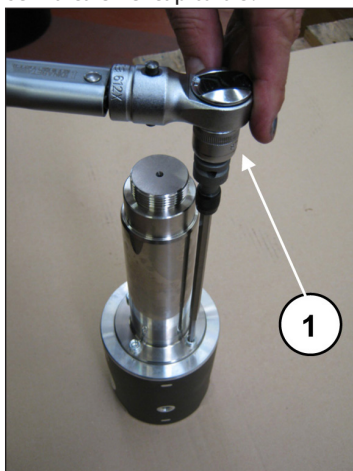

Fig. 40

Introducir la biela en la guía del pistón (pos. ①, Fig. 36) y, a continuación, la clavija (pos. ①, Fig. 35). Aplicar las dos anillas seeger de tope con la herramienta específica (pos. ①, Fig. 34).



Si los componentes están montados correctamente, el pie de biela, la guía del pistón y la clavija debe girar libremente.

Separar los sombreretes de las semibielas; controlar los números laterales para emparejarlos de manera correcta (pos. ①, Fig. 33).

Comprobar que el cárter esté limpio e introducir el grupo semibiela-guía pistón dentro de las levas del cárter (pos. ①, Fig. 32).



Introducir el grupo semibiela-guía del pistón en el cárter de manera que la numeración de las semibielas pueda verse desde arriba.

Bloquear los tres grupos con la herramienta cód. 27566200, (pos. ①, Fig. 31).

Premontar a fondo el cojinete del lado PTO en el eje (pos. ①, Fig. 41) y montar el cojinete en el lado opuesto del cárter (pos. ①, Fig. 42).



El cojinete de la Fig. 42 posee una anilla interna cónica. Comprobar que tanto la parte interna como la externa de la anilla sean cónicas, para permitir la introducción del casquillo.

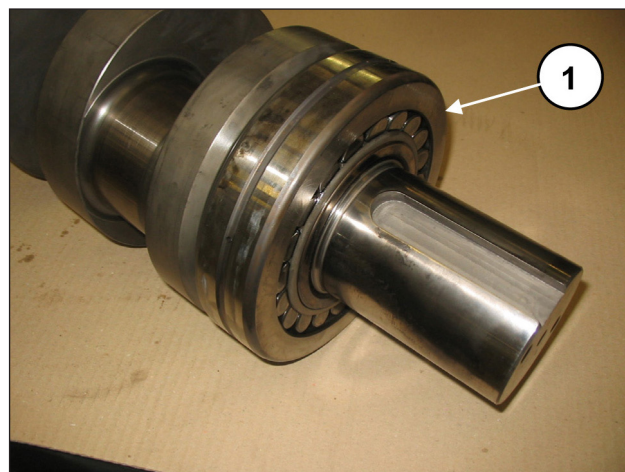

Fig. 41

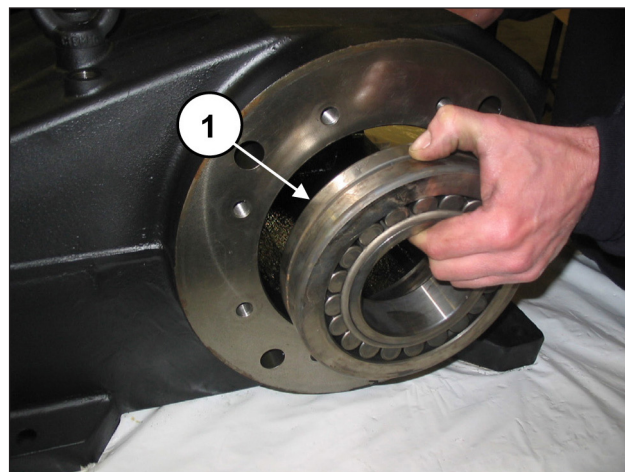

Fig. 42

Introducir el eje (pos. ①, Fig. 29) hasta que el cojinete premontado se encuentre a ras del borde del cárter (pos. ①, Fig. 43).

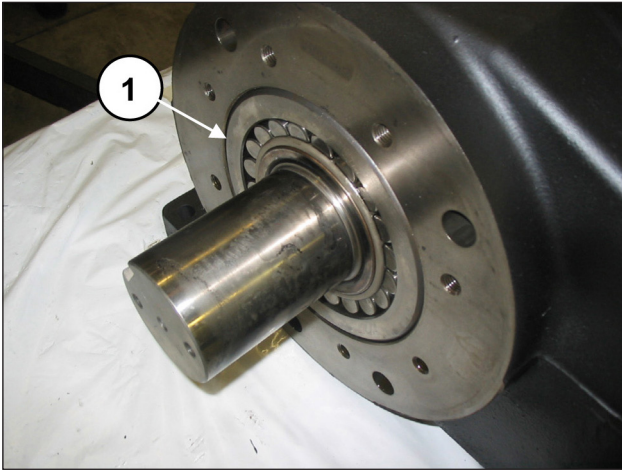

Fig. 43

Introducir el casquillo de presión de manera manual para mantener el eje alineado (pos. ①, Fig. 44).

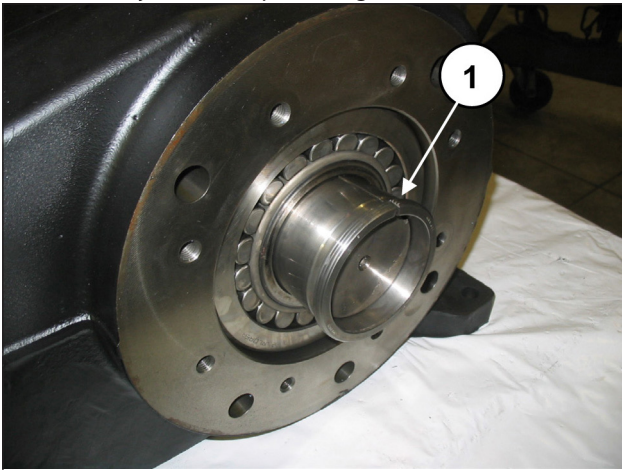

Fig. 44

Montar la caja del reductor (pos. ①, Fig. 45) y la junta correspondiente (pos. ②, Fig. 45) utilizando los 6 tornillos M12x40 (pos. ①, Fig. 46), los 2 tornillos M12x50 (pos. ①, Fig. 47) y las arandelas Grower Ø12 (pos. ②, Fig. 46 y Fig. 47). Ajustar los tornillos con la llave dinamométrica (pos. ①, Fig. 48) como se indica en el capítulo 3.

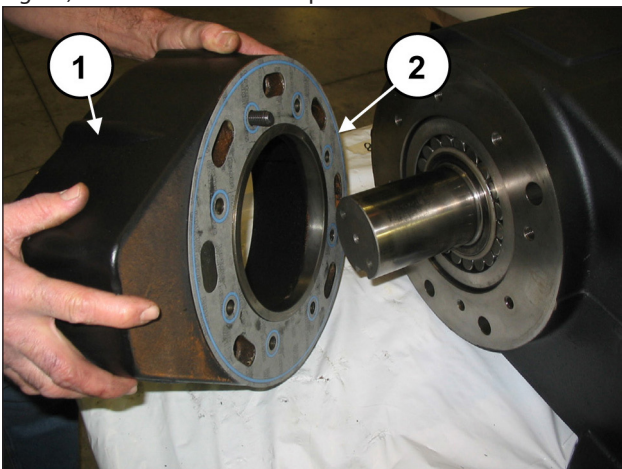

Fig. 45

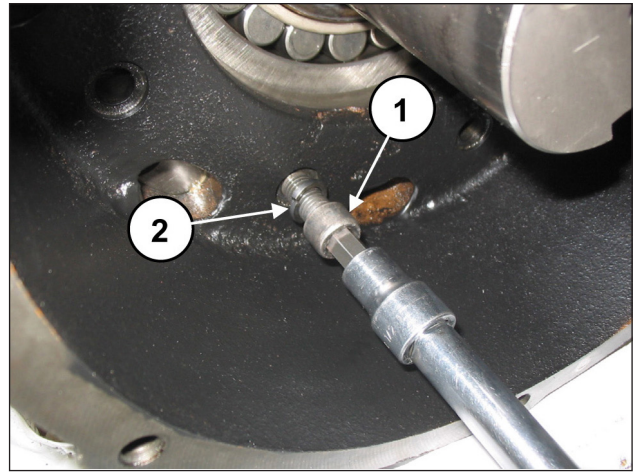

Fig. 46

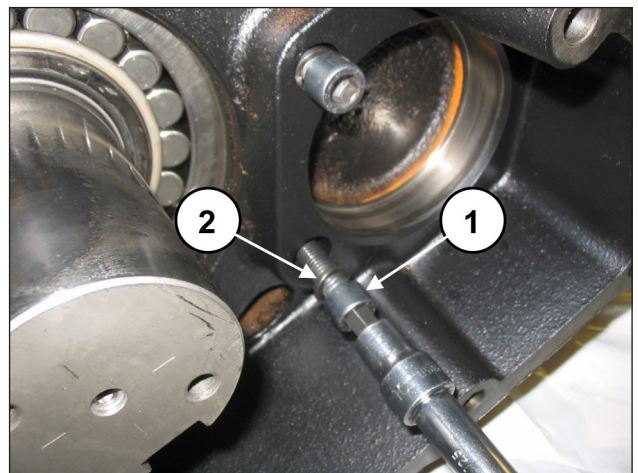

Fig. 47

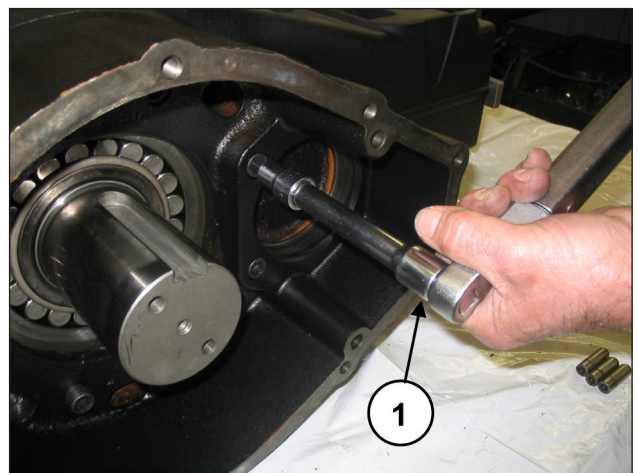

Fig. 48

Introducir a fondo el casquillo de presión en el eje desde el lado opuesto a la PTO (pos. ①, Fig. 49 y Fig. 50).



Fig. 49



Fig. 50



El casquillo de presión se debe introducir en seco (sin aceites ni lubricantes).

Introducir el casquillo hasta que la superficie externa (cónica) acople perfectamente en la parte interna del cojinete. Durante la fase de introducción, comprobar que el cojinete permanezca en contacto con el tope del eje. Medir la cota "X" indicada en la Fig. 51.

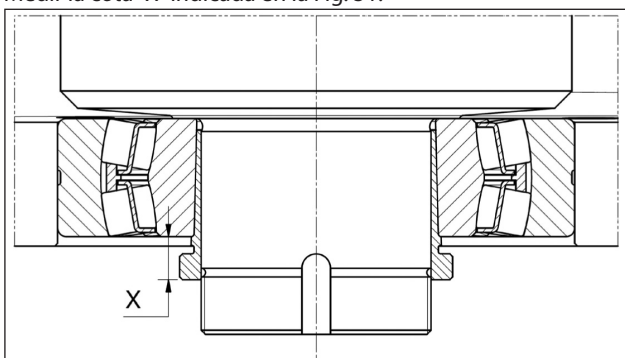

Fig. 51

Enroscar la corona de bloqueo y apretar el casquillo hasta obtener una reducción de la cota "X" entre 0,7 y 0,8 mm (Fig. 52).

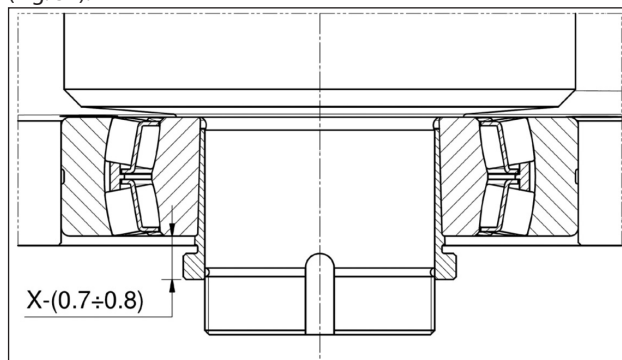

Fig. 52

Desenroscar la corona, introducir la arandela de seguridad (pos. ①, Fig. 53) y enroscar a fondo la corona (pos. ①, Fig. 54). A continuación, doblar la lengüeta de bloqueo de la arandela (pos. ①, Fig. 55).

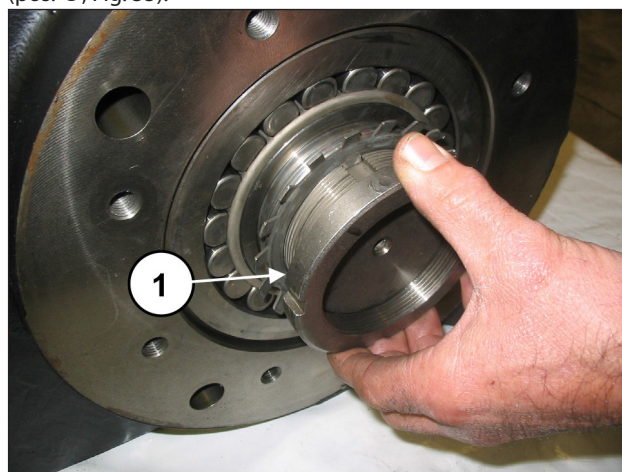

Fig. 53

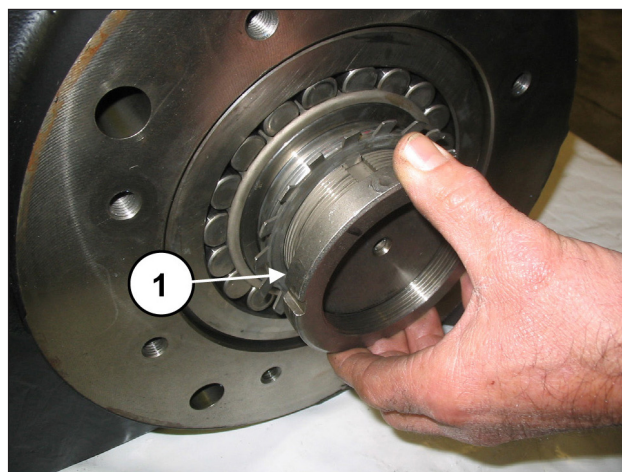

Fig. 54

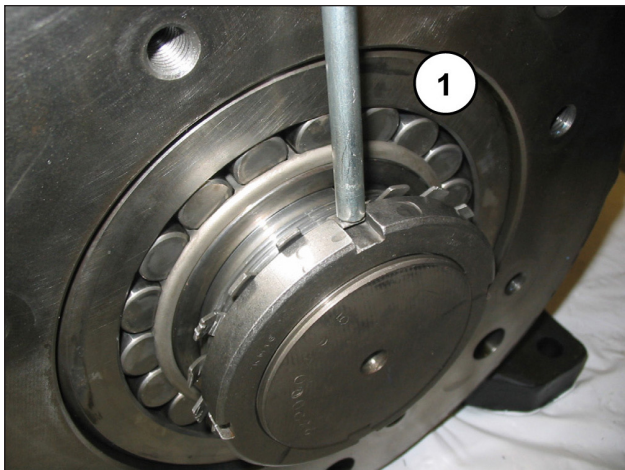

Fig. 55

Desmontar la herramienta que bloquea las bielas cód. 27566200, (pos. ①, Fig. 31).
Introducir los semicojinetes superiores entre las bielas y el eje (pos. ①, Fig. 56).



Para montar correctamente los cojinetes, la lengüeta de referencia de los semicojinetes debe encajar en el alojamiento de la semibiela (pos. ①, Fig. 57).

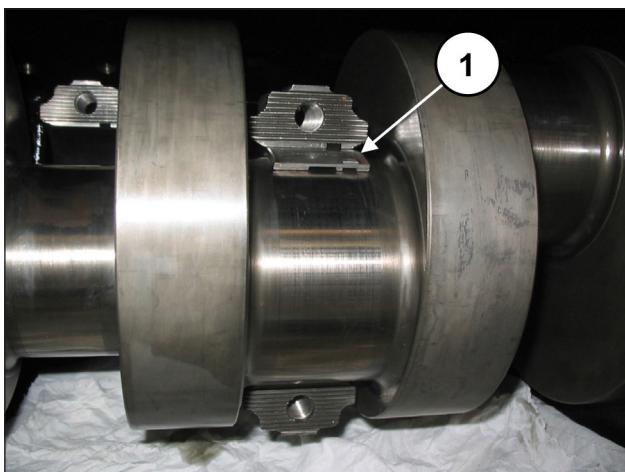

Fig. 56

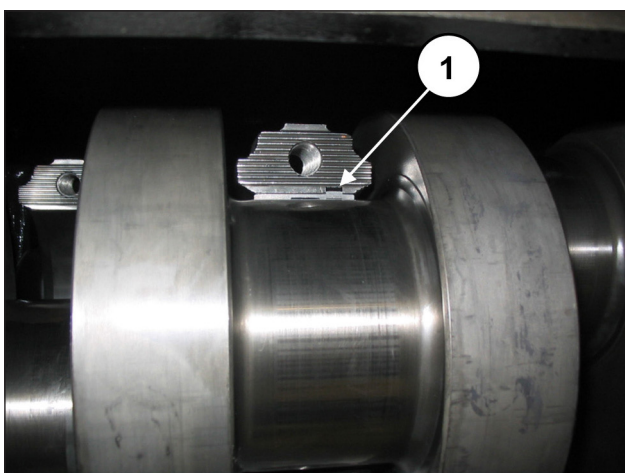

Fig. 57

Montar los semicojinetes inferiores en los sombreretes (pos. ①, Fig. 58). Comprobar que la lengüeta de referencia de los semicojinetes esté dentro del alojamiento del sombrerete (pos. ②, Fig. 58).

Fijar los sombreretes a las semibielas con los tornillos M12x1.25x87 (pos. ①, Fig. 59).



Prestar atención al sentido correcto de montaje de los sombreretes. La numeración debe estar orientada hacia arriba.

Ajustar los tornillos con la llave dinamométrica como se indica en el capítulo 3, aplicando el par de apriete a los tornillos de manera simultánea.

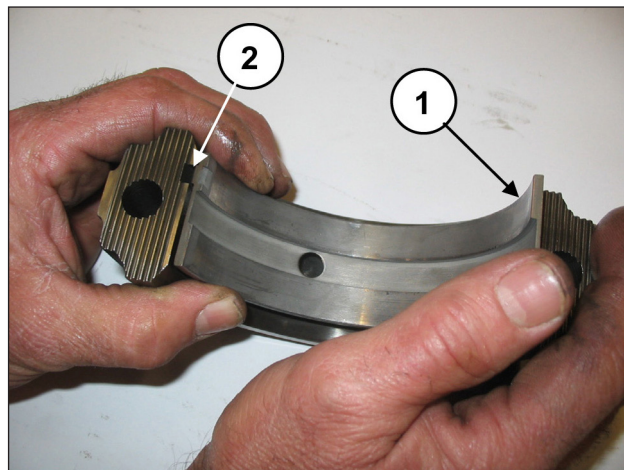

Fig. 58

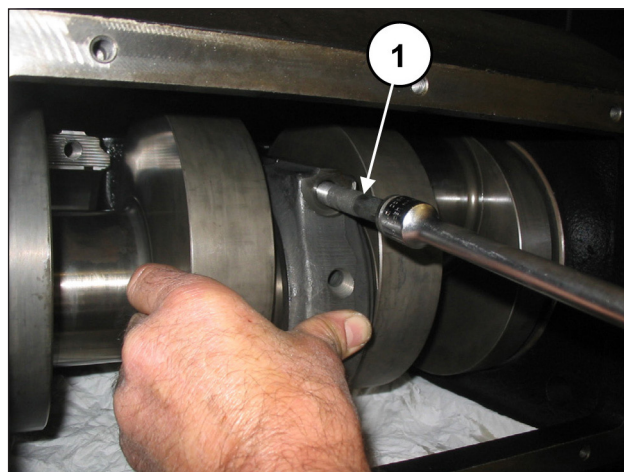

Fig. 59



Ad terminar las operaciones, comprobar la holgura axial de las bielas en ambas direcciones.

Premontar el cojinete en el piñón (pos. ①, Fig. 60) e introducir a fondo el piñón en la sede de la caja del reductor (pos. ①, Fig. 61) con una herramienta de percusión.

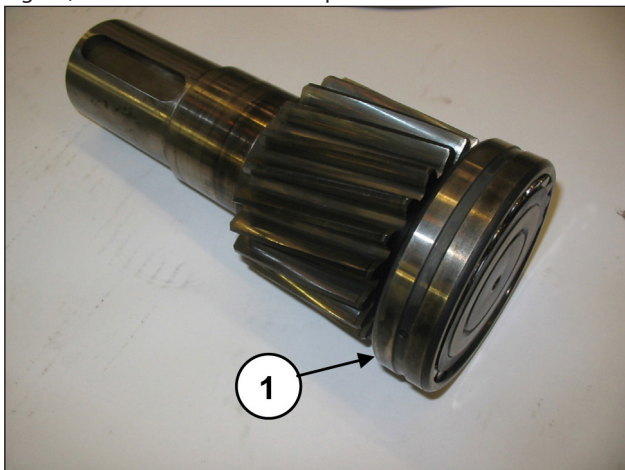

Fig. 60

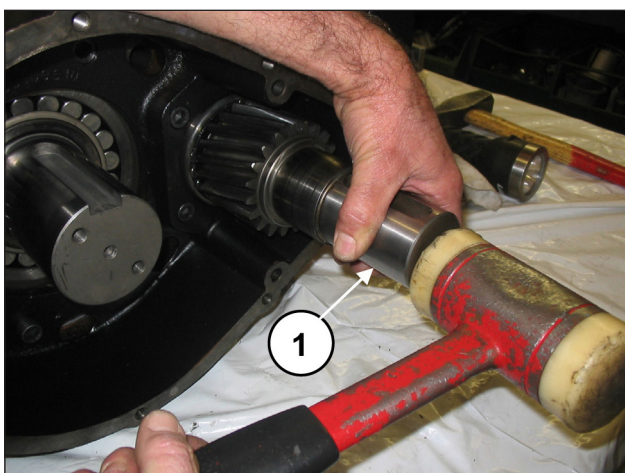

Fig. 61

Introducir la lengüeta 22x14x100 en el alojamiento del eje (pos. ①, Fig. 62) e introducir la corona en el eje. Fijar el tope de la corona (pos. ①, Fig. 63) utilizando los 2 tornillos M10x25 (pos. ②, Fig. 63). Ajustar los tornillos con la llave dinamo-métrica como se indica en el capítulo 3.

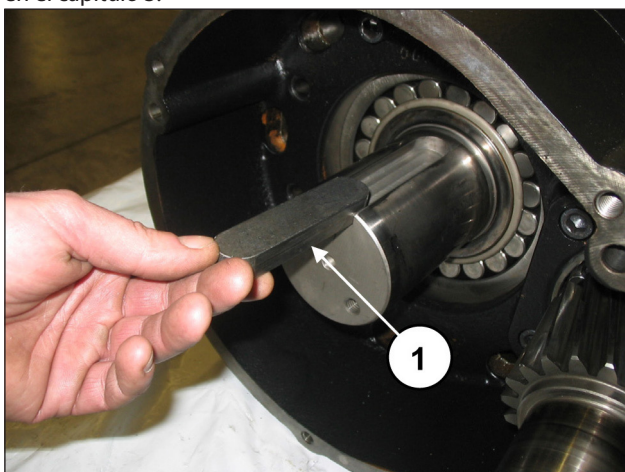

Fig. 62

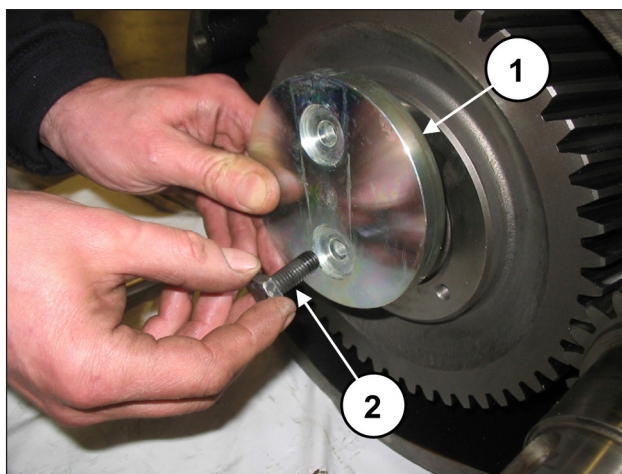

Fig. 63

Colocar las 3 clavijas Ø12x40 en la caja del reductor (pos. ①, Fig. 64) e introducir la junta correspondiente (pos. ①, Fig. 65).

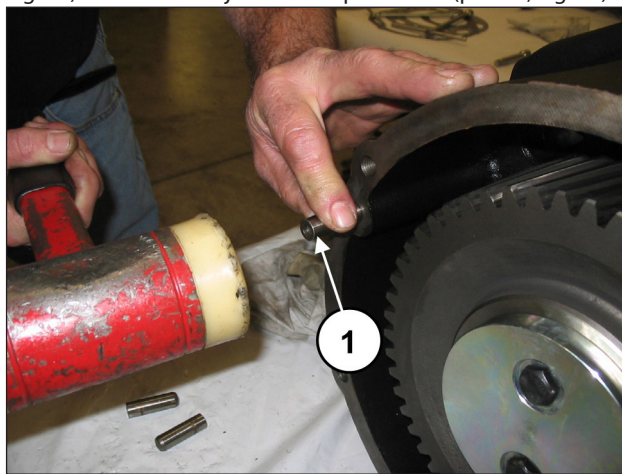

Fig. 64

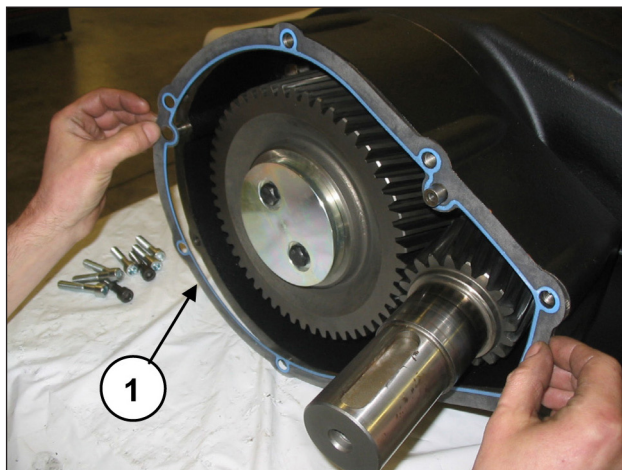

Fig. 65

Montar el cojinete en la tapa del reductor (pos. ①, Fig. 66).

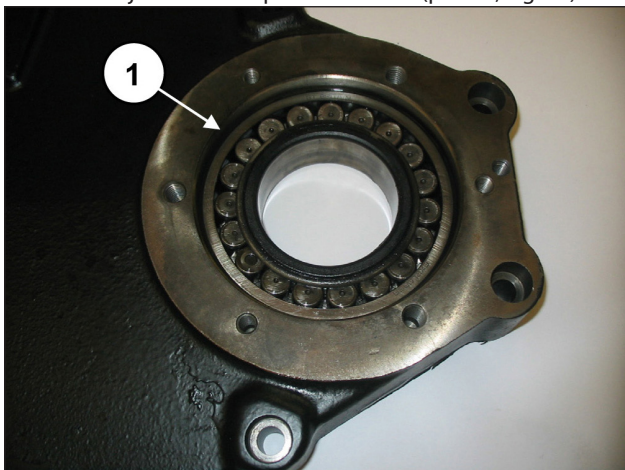

Fig. 66

Montar la tapa del reductor (pos. ①, Fig. 67) y fijarla con los 8 tornillos M10x50 (pos. ①, Fig. 68). Utilizar un tampón para evitar que el cojinete se salga de su alojamiento (pos. ①, Fig. 69).

Ajustar los tornillos con la llave dinamométrica como se indica en el capítulo 3.

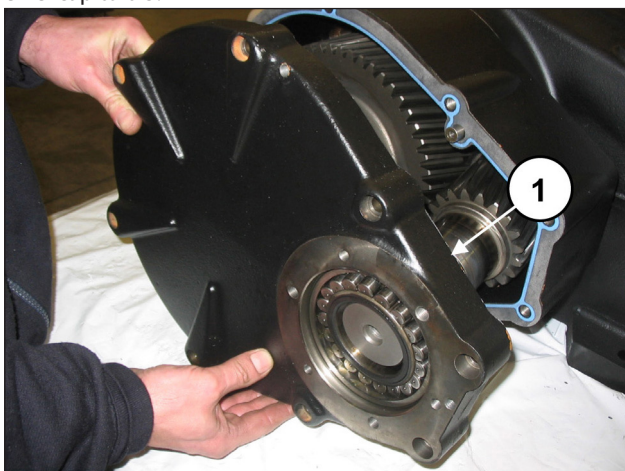

Fig. 67

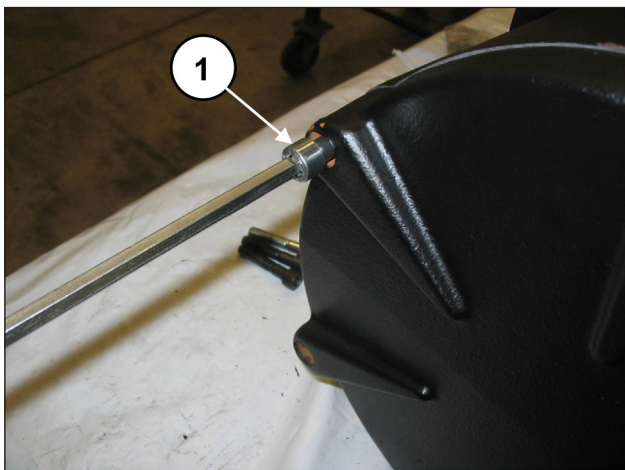

Fig. 68



Fig. 69

Introducir el retén en la brida del reductor utilizando las herramientas cód. 27515900 y 27548200 (pos. ①, Fig. 70). Antes de montar el retén, comprobar las condiciones del labio de estanqueidad. Si se ha de sustituir, colocar una anilla nueva en el fondo del alojamiento como se indica en la Fig. 71.



En el caso que el eje presente un desgaste diametral en correspondencia con el labio de retención, con el fin de evitar tener que realizar la operación de rectificación, es posible volver a colocar la anilla en el segundo tope como se indica en la fig. Fig. 71.

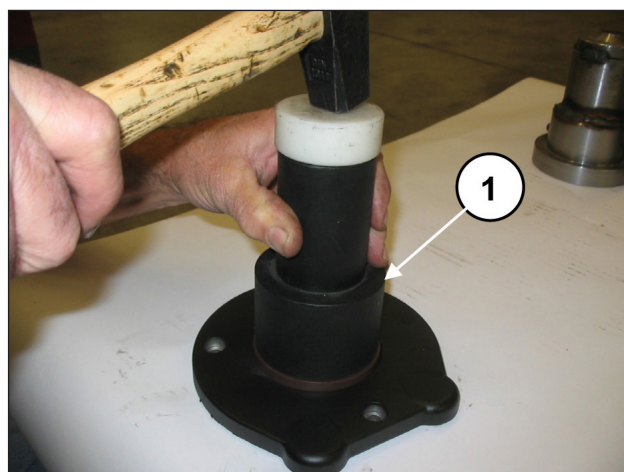

Fig. 70

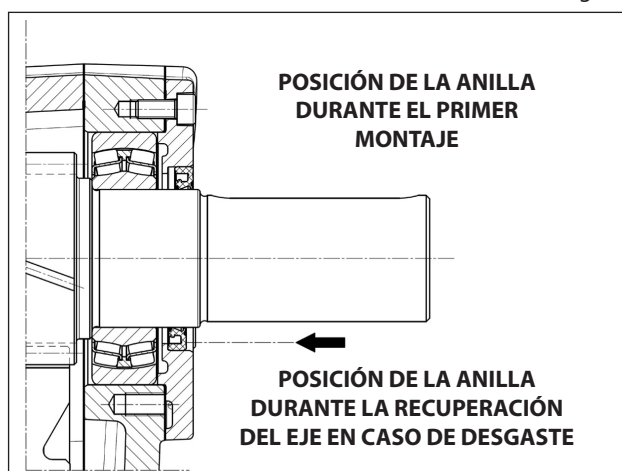

Fig. 71

Aplicar la brida del reductor con la junta en la caja del reductor (pos. ①, Fig. 72) y fijarla con los 3 tornillos M8x18 (pos. ①, Fig. 73).



Introducir la brida en el piñón con cuidado para no dañar el retén.

Ajustar los tornillos con la llave dinamométrica como se indica en el capítulo 3.

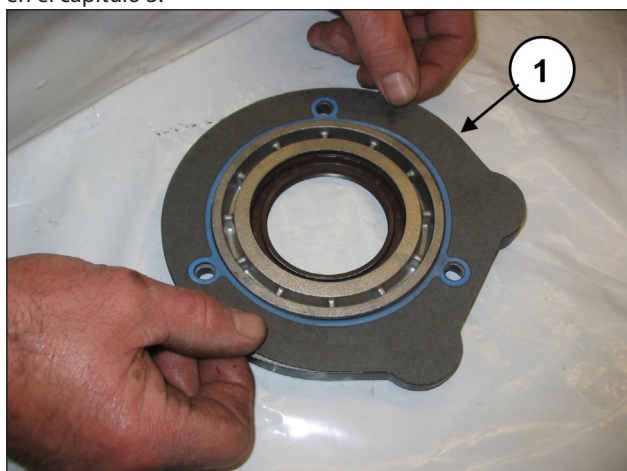

Fig. 72

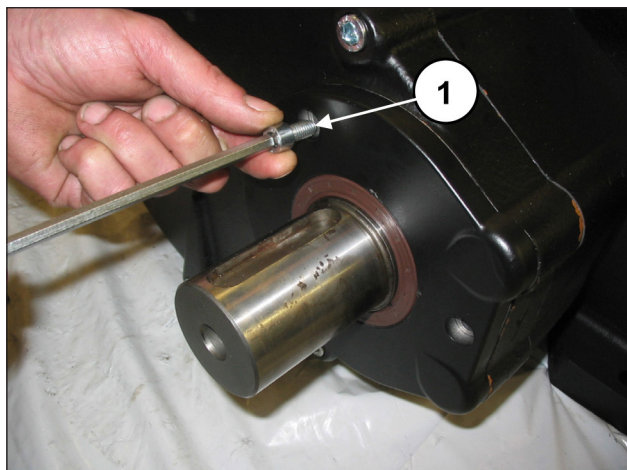

Fig. 73

Introducir la lengüeta 16x10x90 en el piñón.
Introducir la junta tórica en la tapa posterior (pos. ①, Fig. 74) y fijarla al cárter con los 10 tornillos M8x18 (pos. ①, Fig. 75).
Ajustar los tornillos con la llave dinamométrica como se indica en el capítulo 3.



Fig. 74

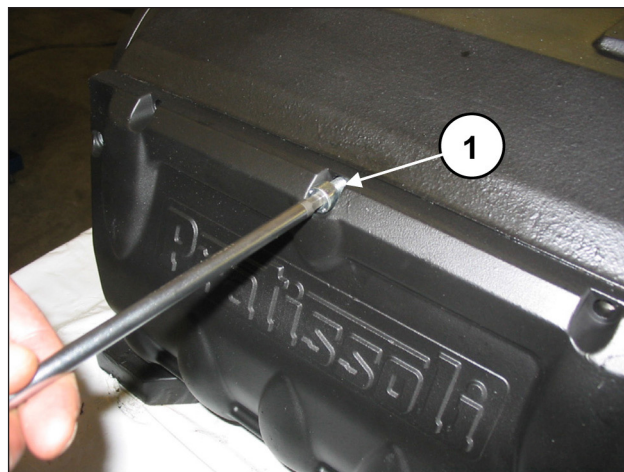

Fig. 75

Montar la tapa del cojinete (y la junta) ①, Fig. 76) con los 8 tornillos M12x30 (pos. ①, Fig. 77).

Ajustar los tornillos con la llave dinamométrica como se indica en el capítulo 3.

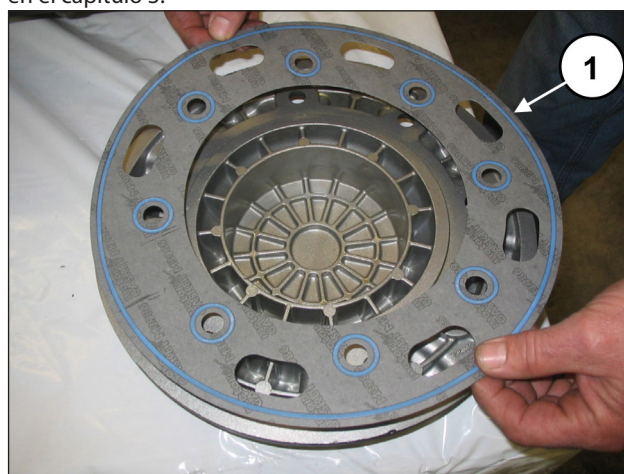

Fig. 76



Fig. 77

Para terminar la fase de montaje de la parte mecánica, aplicar los tapones y los cáncamos de elevación junto con la junta tórica de retén.

Introducir el aceite en el cárter tal y como se indica en el **Manual de uso y mantenimiento**, punto 7.4.

2.1.3 Clases de mayoraciones previstas

TABLA DE MAYORACIONES PARA EJE ACODADO Y SEMICOJINETES DE LA BIELA			
Clases de recuperación (mm)	Código semicojinete superior	Código semicojinete inferior	Rectificación sobre el diámetro del perno del eje (mm)
0.25	90931100	90930100	Ø92.75 0/-0.03 Ra 0.4 Rt 3.5
0.50	90931200	90930200	Ø92.50 0/-0.03 Ra 0.4 Rt 3.5

TABLA DE MAYORACIONES PARA CÁRTER DE LA BOMBA Y GUÍA DEL PISTÓN		
Clases de recuperación (mm)	Código de la guía pistón	Rectificación en alojamiento del cárter de la bomba (mm)
1.00	79050543	Ø81 H6 +0.022/0 Ra 0.8 Rt 6

2.2 REPARACIÓN DE LA PARTE HIDRÁULICA

2.2.1 Desmontaje de la cabeza - grupos de válvulas

La cabeza requiere mantenimiento preventivo como se indica en el *Manual de uso y mantenimiento*.

Las intervenciones se limitan a la inspección o sustitución de las válvulas, en el caso que sea necesario:

Para extraer los grupos de válvula operar del siguiente modo: Aflojar los 8 tornillos M16x55 de la tapa de válvulas (pos. ①, Fig. 78) y desmontar la tapa (pos. ①, Fig. 79).



Fig. 78

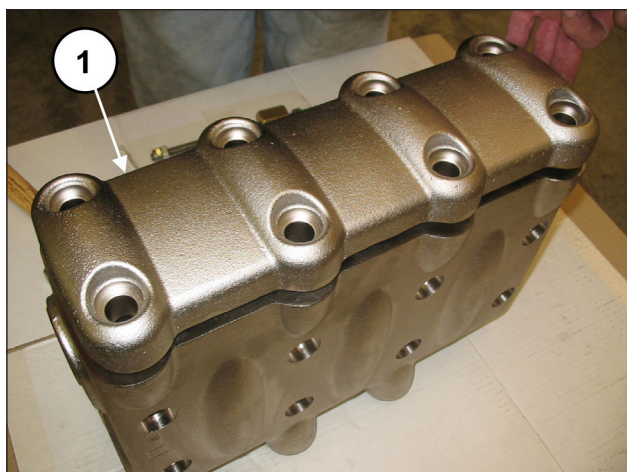

Fig. 79

Extraer el tapón de la válvula introduciendo un extractor de percusión en el orificio M10 del tapón de la válvula (pos. ①, Fig. 80).

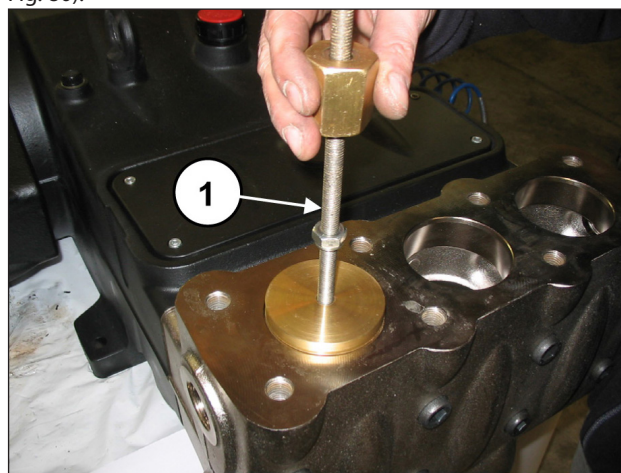

Fig. 80

Extraer el muelle (pos. ①, Fig. 81).

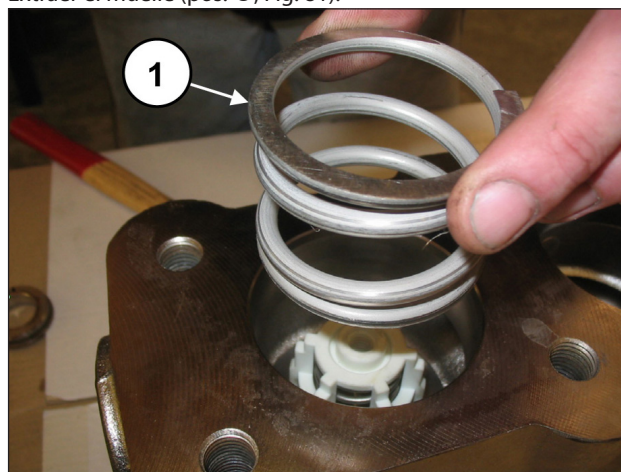

Fig. 81

Extraer el grupo de la válvula de envío introduciendo un extractor de percusión en el orificio M10 de la guía de la válvula (pos. ①, Fig. 82).

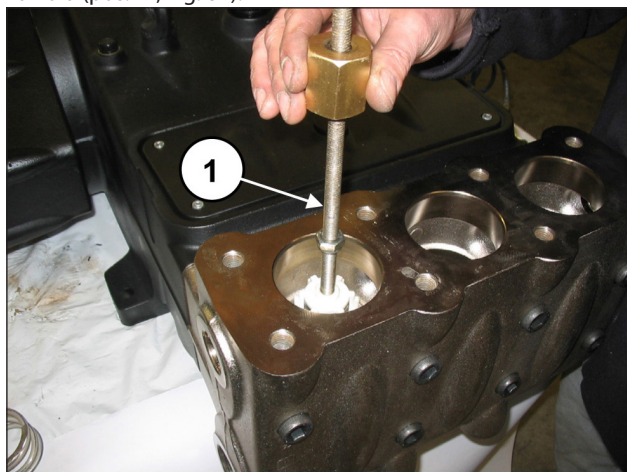

Fig. 82



En caso de dificultad para extraer el grupo de la válvula de envío (por ejemplo, si se han formado depósitos debidos a largos periodos de inactividad de la bomba) utilizar el extractor cód. 27516400.

Extraer el distanciador de la guía de la válvula utilizando una llave hexagonal de 8 mm (pos. ①, Fig. 83).

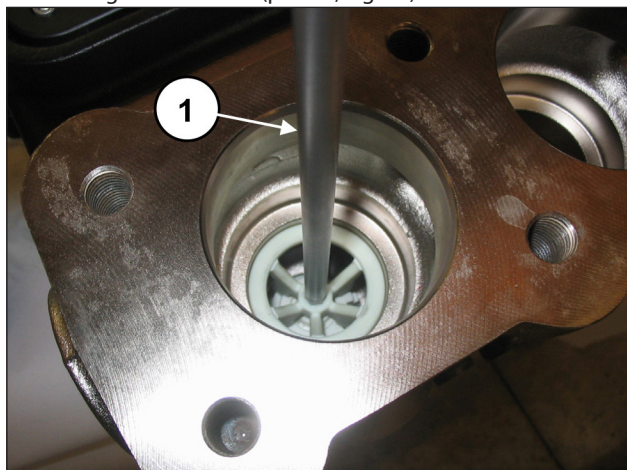

Fig. 83

Extraer el grupo de la válvula de aspiración introduciendo un extractor de percusión en el orificio M10 de la guía de la válvula (pos. ①, Fig. 84).

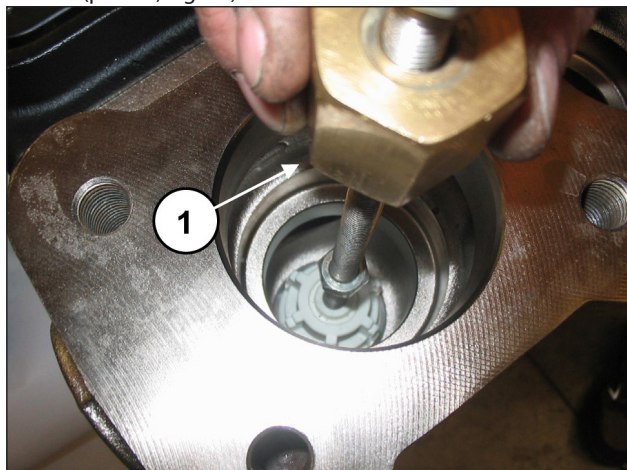

Fig. 84



En caso de dificultad para extraer el grupo de la válvula de aspiración (por ejemplo, si se han formado depósitos debidos a largos periodos de inactividad de la bomba) utilizar el extractor cód.27516200 (en las versiones con Ø de pistón: 40 - 45 - 50) o cód. 27516300 (en las versiones con Ø de pistón: 55 - 60 - 65).

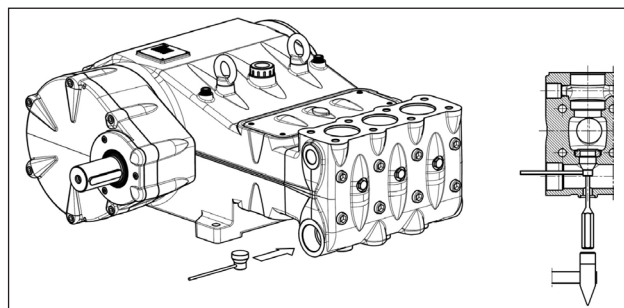

Fig. 85

Desenroscar el dispositivo de apertura de las válvulas con una llave de 30 mm (pos. ①, Fig. 86).



Fig. 86

Desmontar los grupos de las válvulas de aspiración y envío atornillando un tornillo M10 para presionar la guía interna y extraer la guía de la válvula de la sede (pos. ①, Fig. 87).

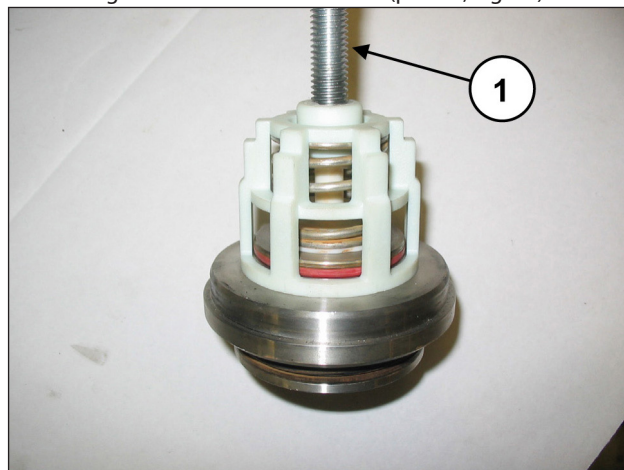

Fig. 87

2.2.2 Montaje de cabeza – grupos de válvulas



Controlar el desgaste de los componentes y sustituirlos si es necesario.

A cada inspección de las válvulas, sustituir todas las juntas tóricas sea de los grupos que de los tapones de válvula.



Antes de volver a colocar los grupos de válvula, limpiar y secar perfectamente los correspondientes alojamientos en la cabeza tal y como indican las flechas (pos. ①, Fig. 88).

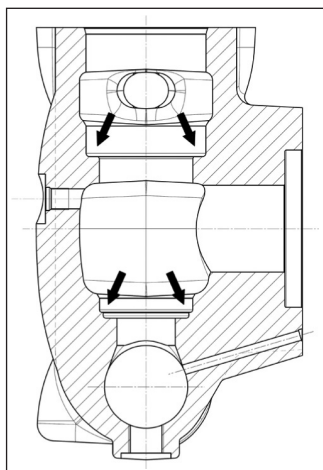

Fig. 88

Seguir en orden contrario la secuencia de desmontaje descrita en el apart. 2.2.1.

Ensamblar los grupos de las válvulas de aspiración y envío (Fig. 89 y Fig. 90) sin invertir los muelles desmontados anteriormente.

Para facilitar la introducción de la guía de la válvula en su sede se puede utilizar un tubo que apoye sobre los pisos horizontales de la guía (Fig. 91) y utilizar un martillo de timbre actuando sobre toda la circunferencia.



Fig. 89

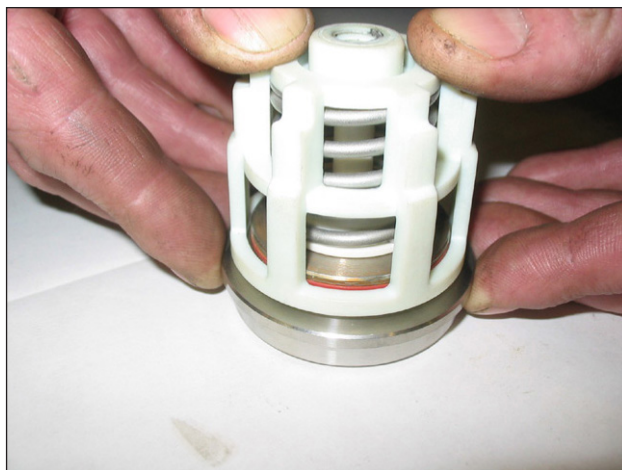

Fig. 90

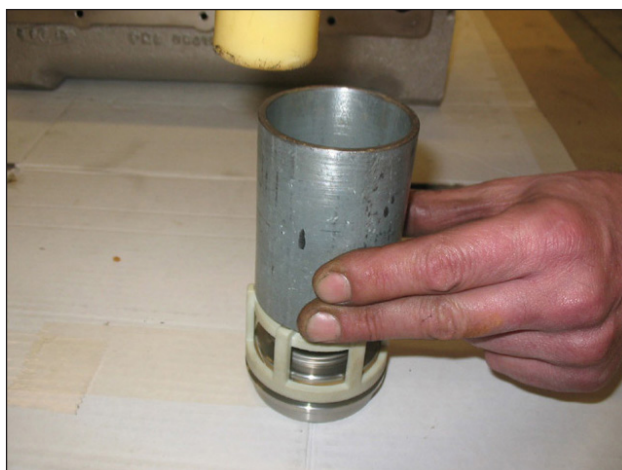

Fig. 91



Introducir los grupos de las válvulas de aspiración y envío en la cabeza, controlando la secuencia de introducción de las juntas tóricas y de las anillas anti extrusión.

La secuencia correcta de montaje de los grupos de válvulas en la cabeza es la siguiente:

Introducir la anilla anti extrusión, pos. dibujo desglosado 4 (pos. ①, Fig. 92).

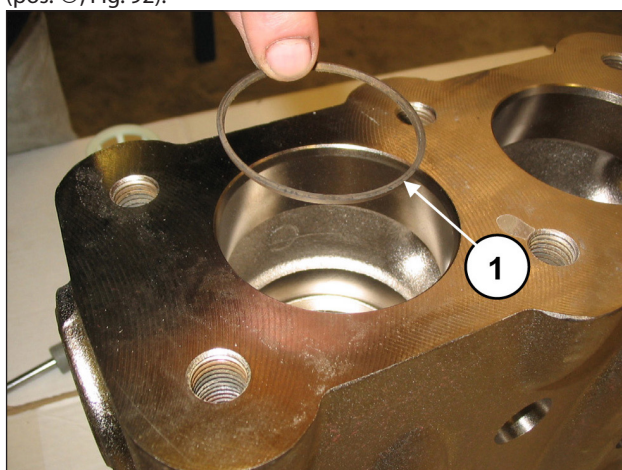

Fig. 92

Introducir la junta tórica, pos. dibujo desglosado 5 (pos. ①, Fig. 93).

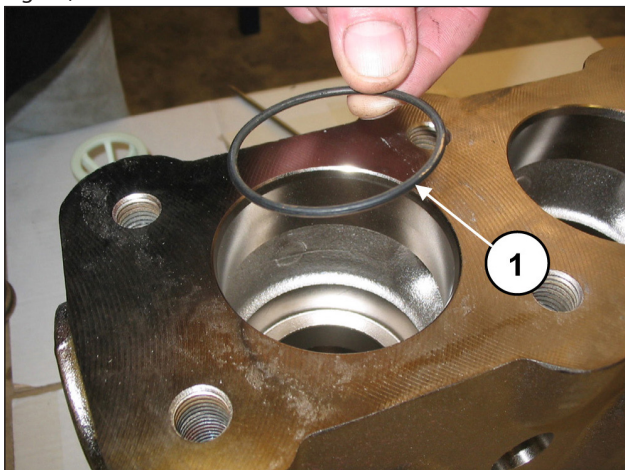

Fig. 93

Comprobar que la junta tórica y la anilla anti extrusión estén colocadas de manera correcta en el alojamiento. Introducir el grupo de la válvula de aspiración (pos. ①, Fig. 94) y, a continuación, el distanciador (pos. ①, Fig. 95). El grupo de la válvula se ha de introducir a fondo como se indica en la pos. ①, Fig. 95.

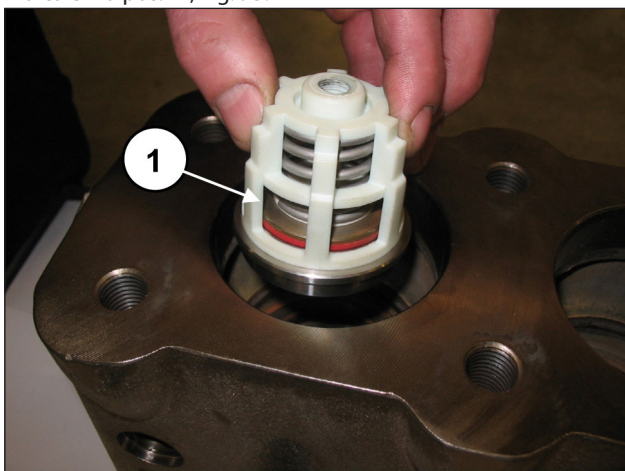

Fig. 94

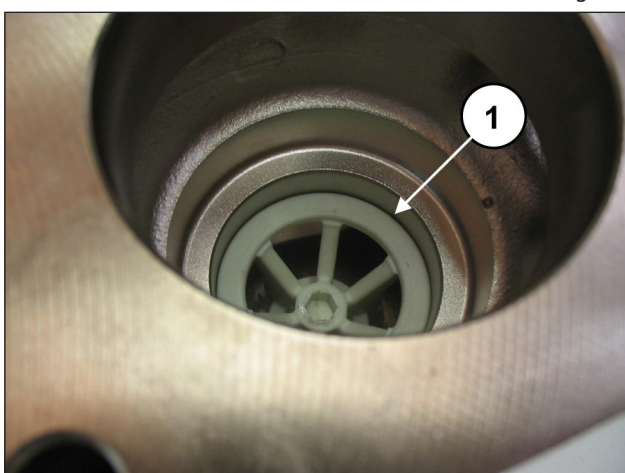

Fig. 95

Montar la junta tórica, pos. dibujo desglosado 5 (pos. ①, Fig. 96) y la anilla anti extrusión pos. desglosado 15 (pos. ②, Fig. 96) en la sede de la válvula de envío.

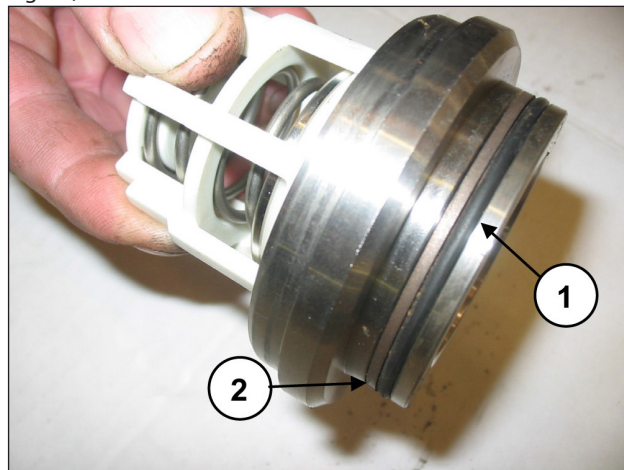

Fig. 96

Introducir el grupo de la válvula de envío (pos. ①, Fig. 97). El grupo de la válvula se ha de introducir a fondo como se indica en la pos. ①, Fig. 98.

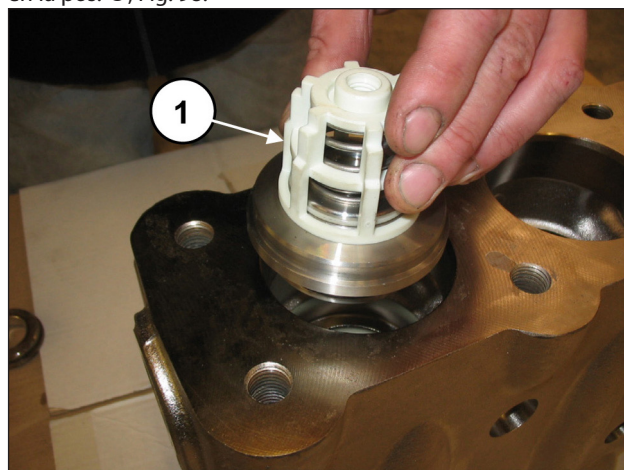

Fig. 97

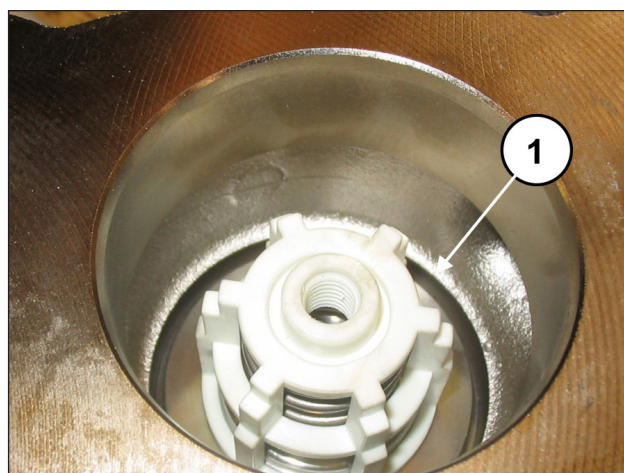

Fig. 98

Introducir la anilla anti extrusión, pos. dibujo desglosado 16 (pos. ①, Fig. 99).

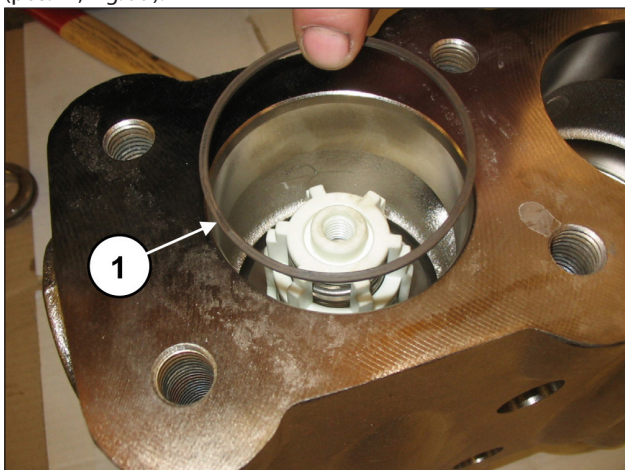

Fig. 99

Introducir la anilla del alojamiento de la válvula (pos. ①, Fig. 102) y el muelle (pos. ①, Fig. 103).

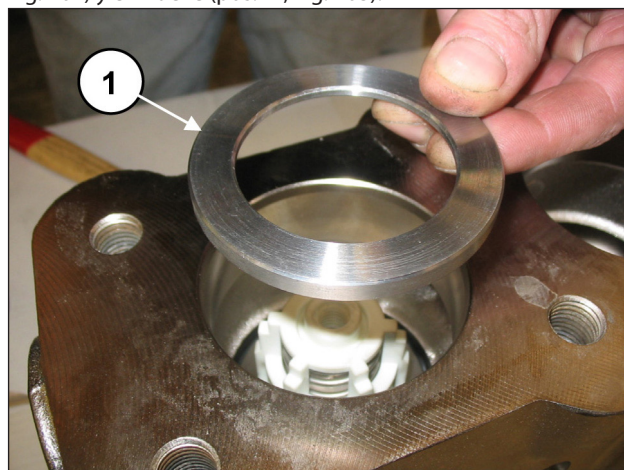

Fig. 102

Introducir la junta tórica, pos. dibujo desglosado 17 (pos. ①, Fig. 100).

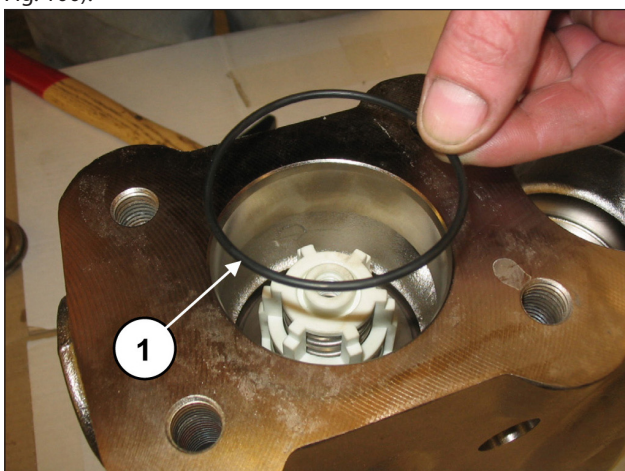

Fig. 100



Introducir con atención la junta tórica indicada en la pos. ①, Fig. 101.

Se recomienda utilizar la herramienta cód. 27516000 (en las versiones con Ø de pistón: 40 - 45 - 50) o cód. 27516100 (en las versiones con Ø de pistón: 55 - 60 - 65) para no cortar la junta tórica al introducirla.

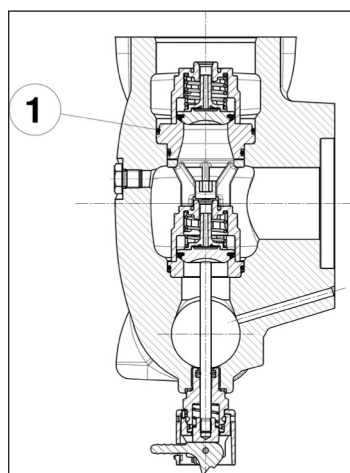

Fig. 101

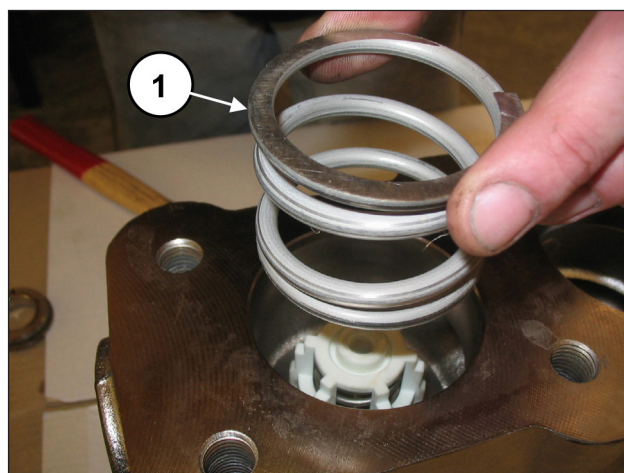

Fig. 103

Montar la junta tórica, pos. dibujo desglosado 17 (pos. ①, Fig. 104) y la anilla anti extrusión pos. desglosado 21 (pos. ②, Fig. 104) en el tapón de la válvula de envío.

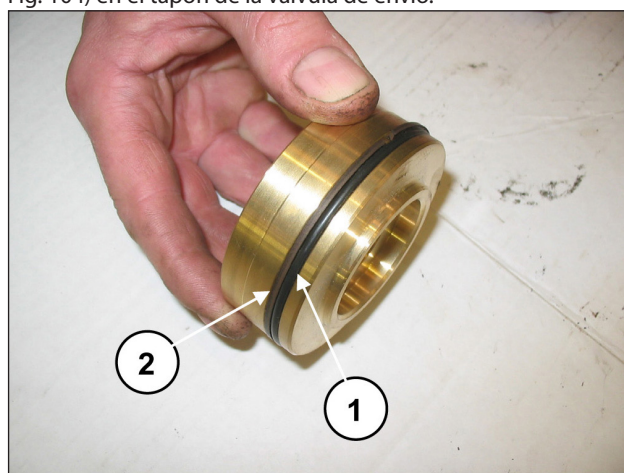

Fig. 104

Introducir el tapón de la válvula con la junta tórica y las anillas anti extrusión.

Al terminar de montar los grupos y el tapón de la válvula, aplicar la tapa de las válvulas (pos. ①, Fig. 105) y apretar los 8 tornillos M16x55 (pos. ①, Fig. 106).

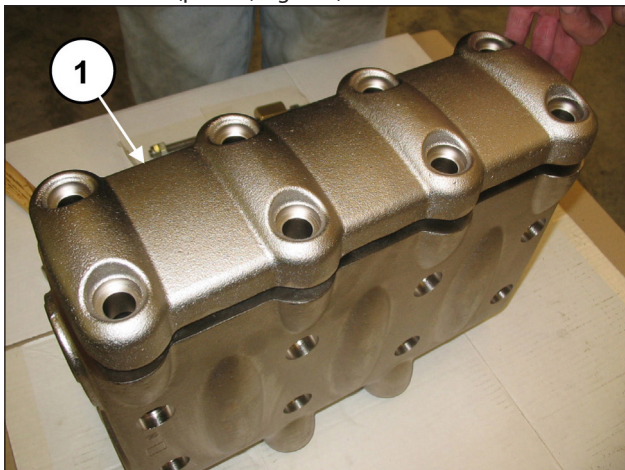

Fig. 105

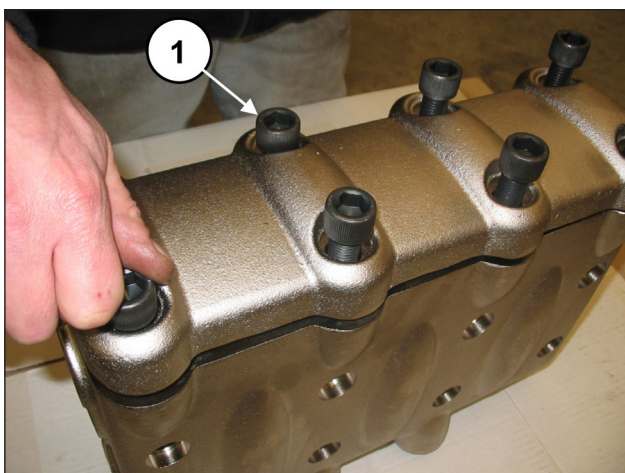

Fig. 106

Montar la cabeza en el cárter de la bomba (pos. ①, Fig. 107) sin golpear los pistones y apretar los 8 tornillos M16x180 (pos. ①, Fig. 108).

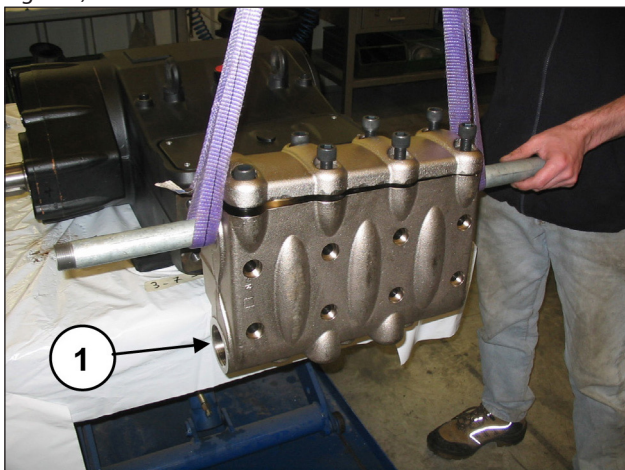

Fig. 107

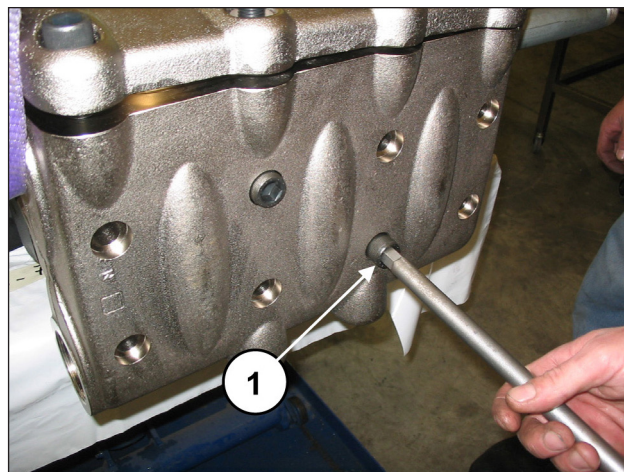

Fig. 108

Ajustar los tornillos M16x180 con la llave dinamométrica como se indica en el capítulo 3.



Apretar en diagonal los 4 tornillos M16x180 internos (ver Fig. 107) y a continuación los 4 externos.

Ajustar los tornillos M16x55 con la llave dinamométrica como se indica en el capítulo 3.

Aplicar los dispositivos de apertura de las válvulas (pos. ①, Fig. 109) y enroscarlos con la llave de 30 mm (pos. ①, Fig. 110).

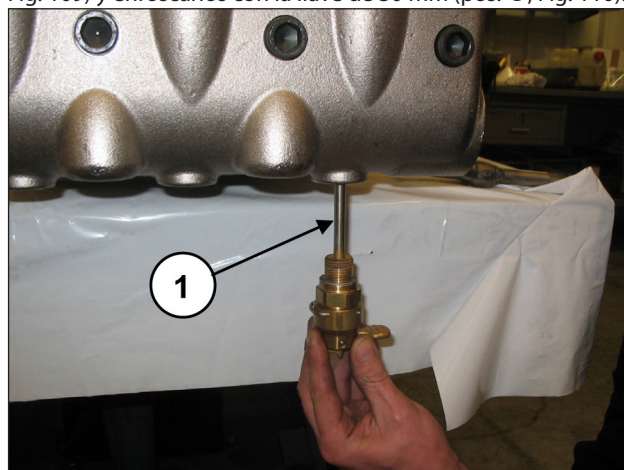

Fig. 109

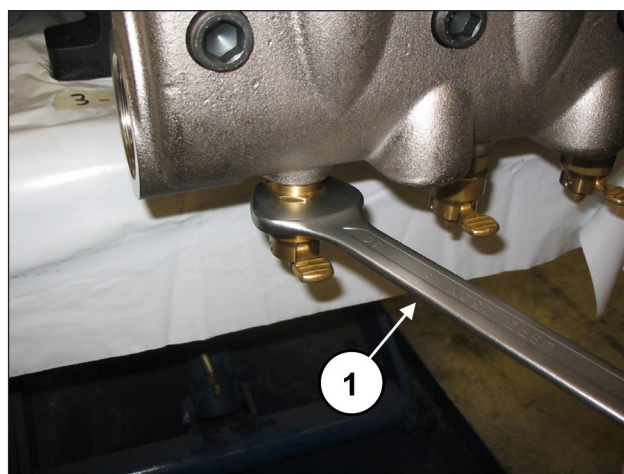

Fig. 110

2.2.3 Desmontaje del grupo pistón - soportes - juntas

Controlar el grupo del pistón de manera periódica como se indica en la tabla de mantenimiento preventivo del **Manual de uso y mantenimiento**.

Controlar de manera visual el drenaje del orificio de la tapa inferior. Si se detectan anomalías y oscilaciones en el manómetro de envío o pérdidas por el orificio de drenaje, controlar y sustituir el paquete de juntas.

Para extraer los grupos de pistón operar del siguiente modo: Para acceder al grupo de pistón, es necesario aflojar los tornillos M16x180 y desmontar la cabeza.

 **Extraer la cabeza con cuidado para no golpear los pistones.**

Desmontar los pistones aflojando los tornillos de fijación (pos. ①, Fig. 111).

Extraer el pistón del soporte de juntas y comprobar que su superficie no esté rayada ni presente signos de desgaste o cavitación.

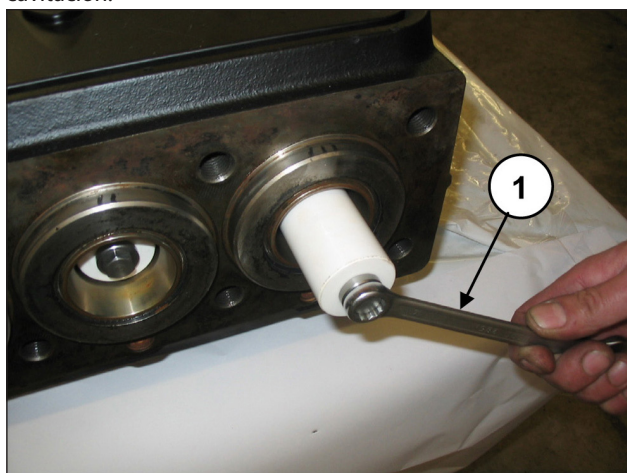

Fig. 111

Quitar la tapa de inspección superior aflojando los 4 tornillos de fijación (pos. ①, Fig. 112).

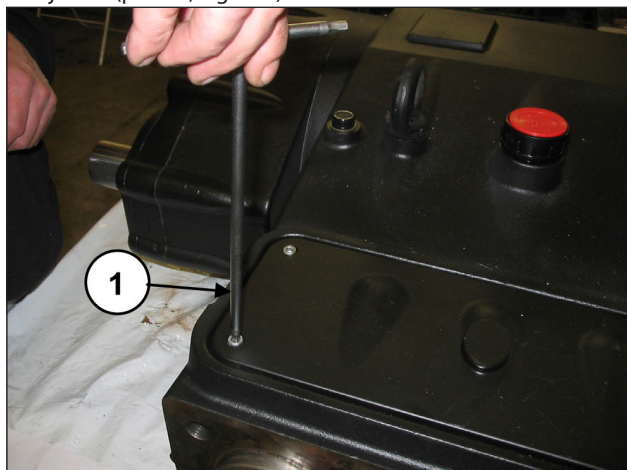

Fig. 112

Girar a mano el eje para situar los 3 pistones en el punto muerto superior.

Introducir la herramienta tampón (cód. 27516600 entre la guía del pistón y el pistón (pos. ①, Fig. 113).

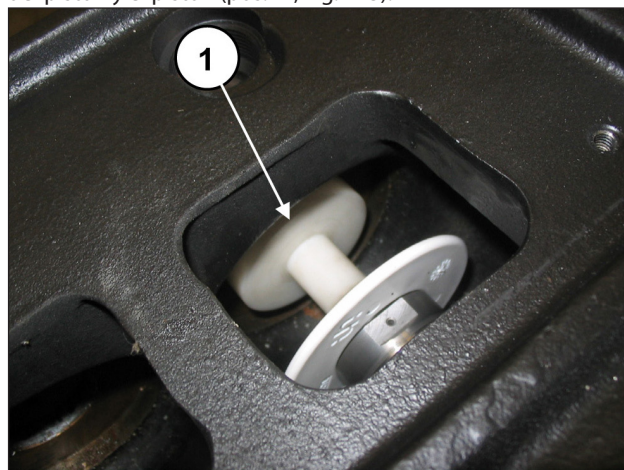

Fig. 113

Girar el eje para desplazar la guía del pistón de manera que el tampón avance y expulse el soporte de las juntas y el grupo del pistón completo (pos. ①, Fig. 114).

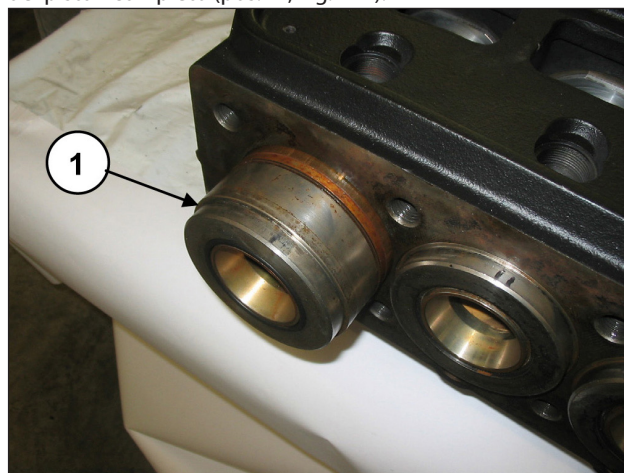

Fig. 114

Extraer el grupo de soporte de las juntas y la herramienta tampón.

Extraer la junta tórica del fondo del soporte de la junta si se queda dentro del cárter de la bomba (pos. ①, Fig. 115).

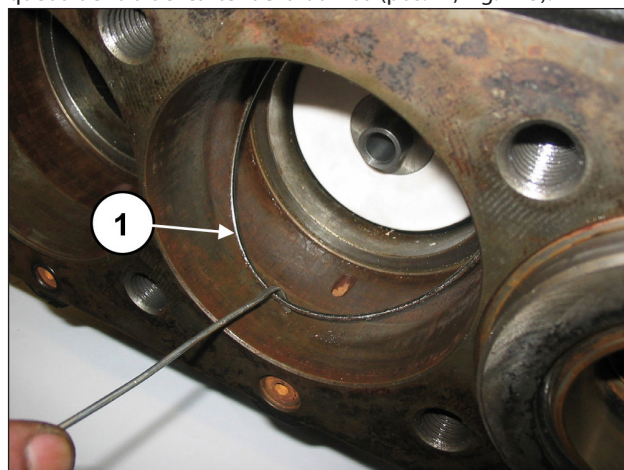

Fig. 115

Extraer de las guías de los pistones las anillas de protección contra las salpicaduras (pos. ①, Fig. 116).

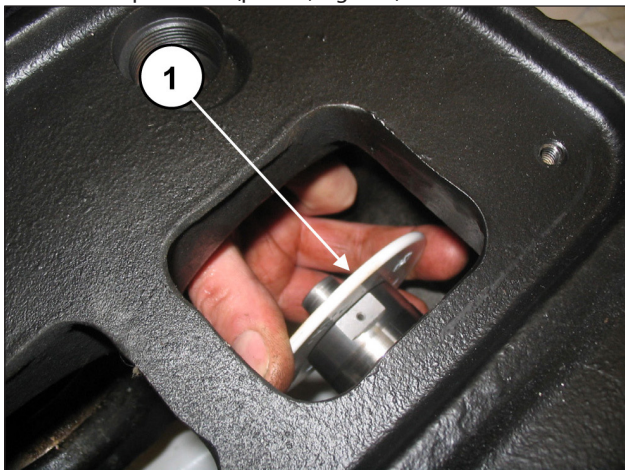

Fig. 116

Si es necesario sustituir el retén de la guía del pistón, desmontar la tapa de retención como se indica a continuación: Aflojar los 2 tornillos de bloqueo de la tapa de retención (pos. ①, Fig. 117).

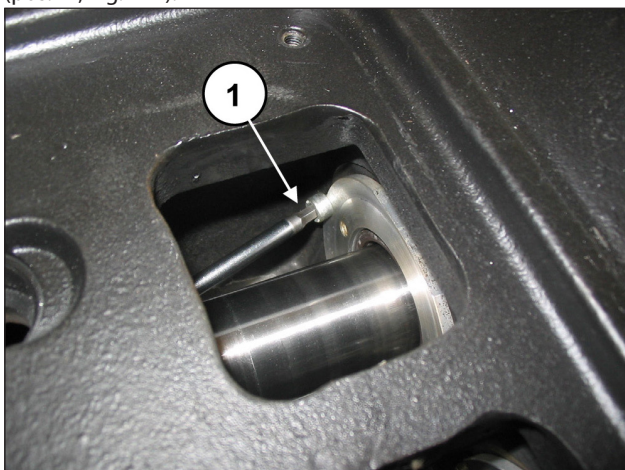

Fig. 117

Colocar la guía del pistón en el punto muerto inferior, enroscar el extractor cód. 27516400 junto con el adaptador M5 cód. 27516500 en los orificios de la tapa (pos. ①, Fig. 118) y extraer la tapa de retención del grupo de la bomba (pos. ①, Fig. 119).

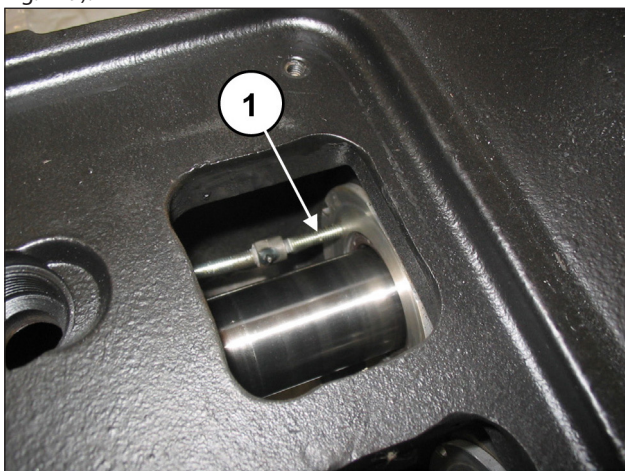

Fig. 118



Fig. 119

Sustituir el retén (pos. ①, Fig. 120) y la junta tórica externa (pos. ②, Fig. 120).

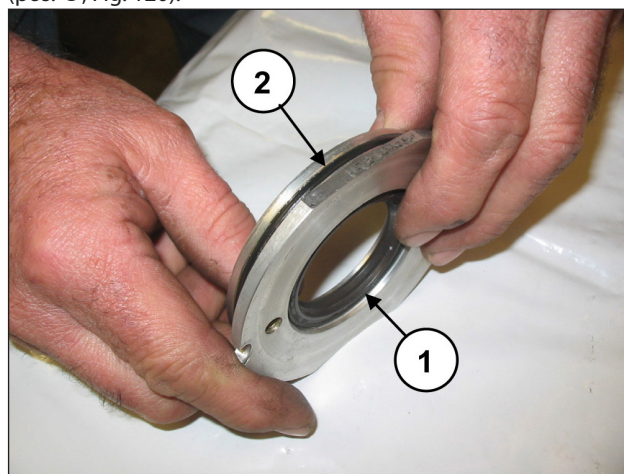

Fig. 120

Separar el soporte de las juntas de la camisa (pos. ①, Fig. 121) para acceder a las juntas de presión (pos. ①, Fig. 122).

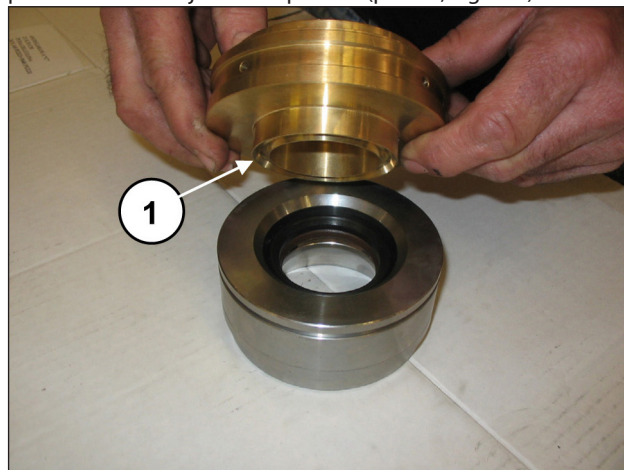

Fig. 121



Fig. 122

Para quitar la junta de baja presión, es necesario utilizar un espesímetro o una herramienta que no dañe el alojamiento del soporte de la junta (pos. ①, Fig. 123).

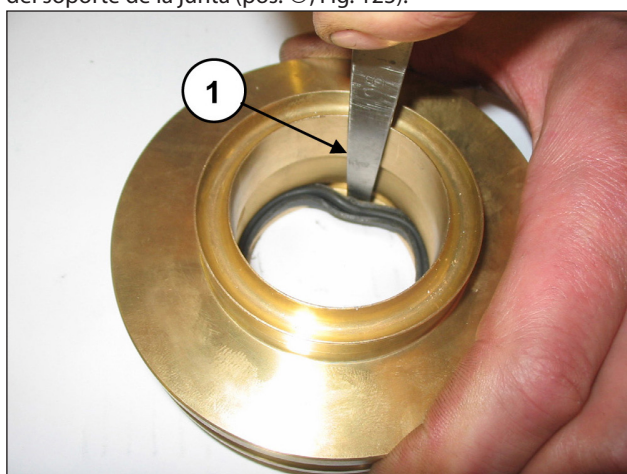

Fig. 123

2.2.4 Montaje del grupo pistón - soportes - juntas

Seguir en orden contrario la secuencia de desmontaje descrita en el apart. 2.2.3.



Sustituir las juntas de presión, para ello humedecer los labios con grasa de silicona (sin esparcir) e introducir las en la camisa con cuidado para no dañarlas.



Sustituir las juntas de presión y las juntas tóricas cada vez que se realicen operaciones de desmontaje.

Introducir la junta de baja presión en el soporte de la junta (pos. ①, Fig. 124) controlando el sentido de montaje (el labio de retención debe estar hacia adelante, hacia el cabezal).

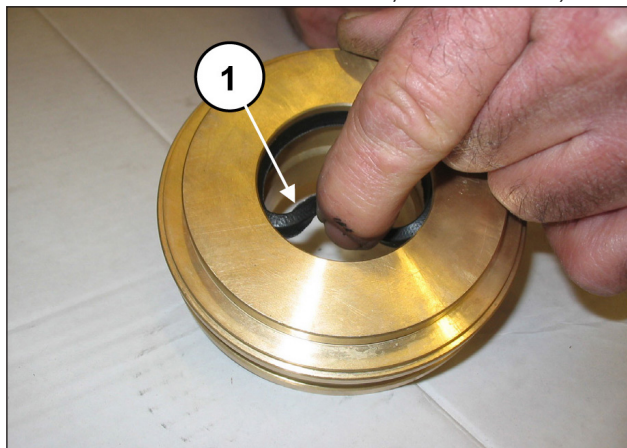

Fig. 124

Montar la anilla del cuello (pos. ①, Fig. 125), la junta de alta presión (pos. ①, Fig. 126) y la anilla restop (pos. ①, Fig. 127).

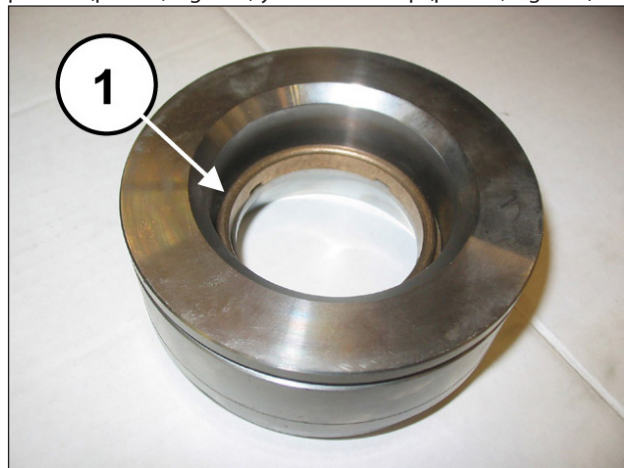

Fig. 125

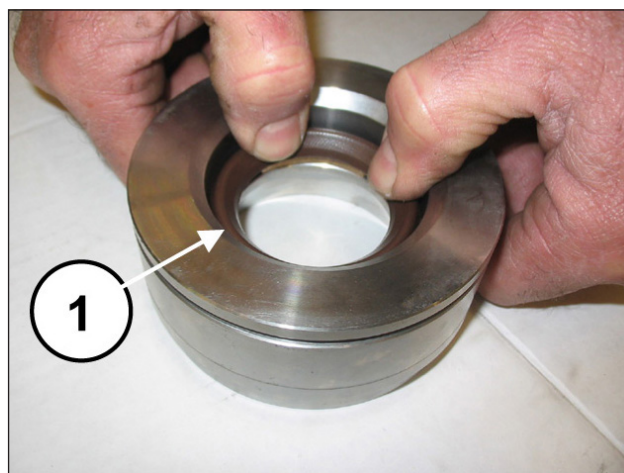

Fig. 126



Fig. 127

Unir el soporte de las juntas a la camisa (pos. ①, Fig. 128).

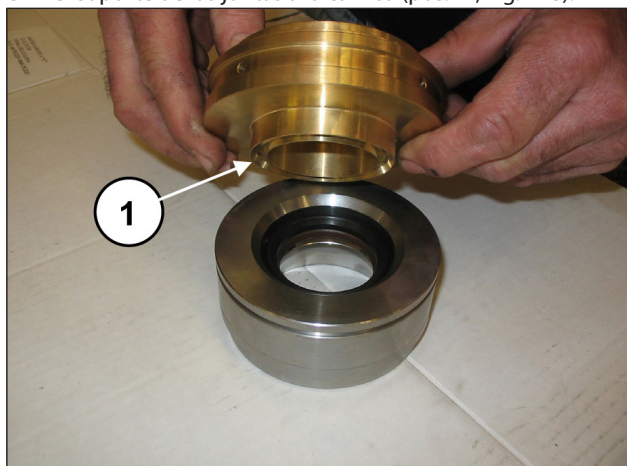

Fig. 128

Montar el retén en la tapa de retención (pos. ①, Fig. 129) utilizando un tampón cód. 27910900.

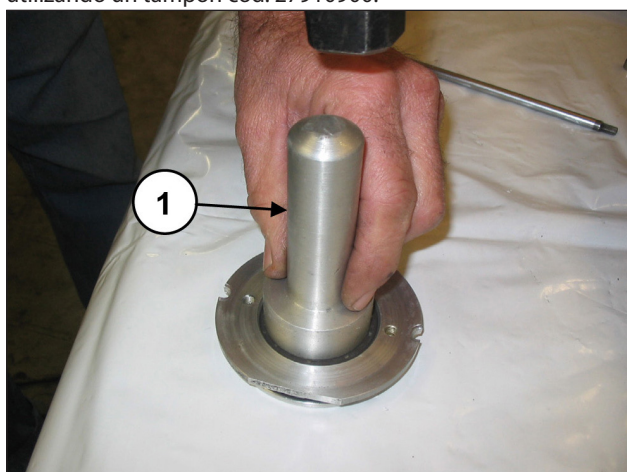

Fig. 129

Colocar la junta tórica (pos. ①, Fig. 130) en el alojamiento de la tapa de retención e introducir el grupo montado dentro del cárter en el alojamiento específico (pos. ①, Fig. 131).

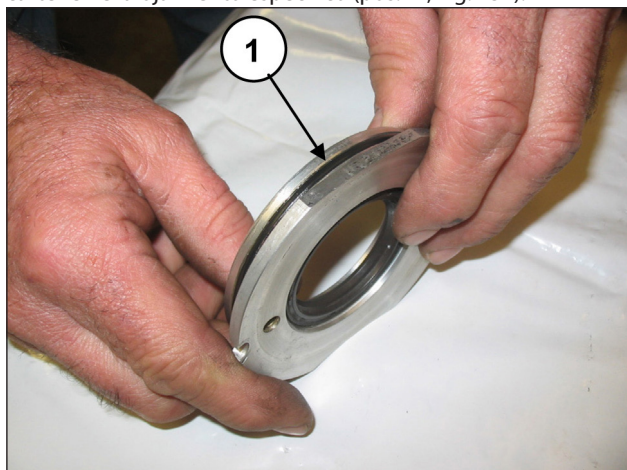

Fig. 130

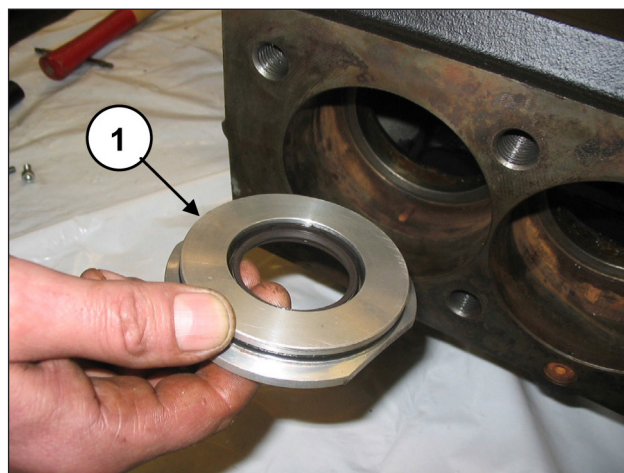

Fig. 131

Comprobar que la tapa entre a fondo en el alojamiento (pos. ①, Fig. 132). No dañar el labio del retén. Fijar las tapas de retención con 2 tornillos M6x14 (pos. ①, Fig. 133).

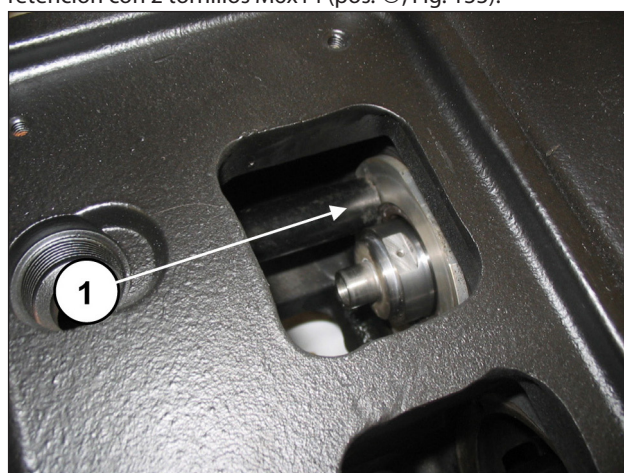

Fig. 132

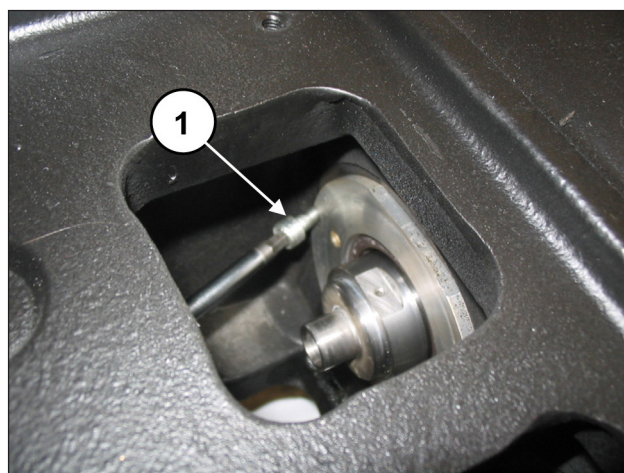

Fig. 133

Ajustar los tornillos con la llave dinamométrica como se indica en el capítulo 3.

Colocar los protectores contra salpicaduras junto con las juntas tóricas en el alojamiento de la guía del pistón (pos. ①, Fig. 134 y Fig. 135).

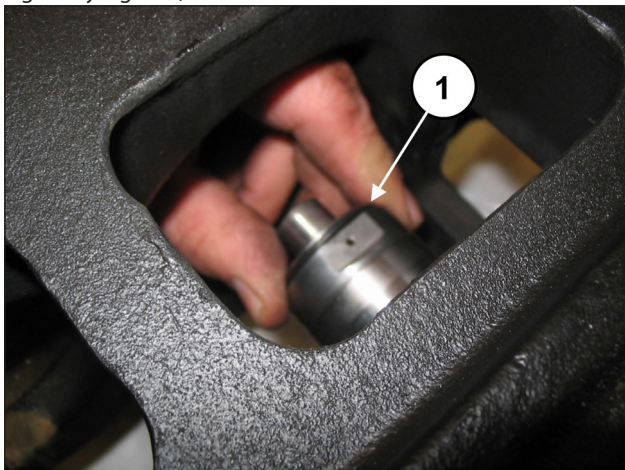

Fig. 134

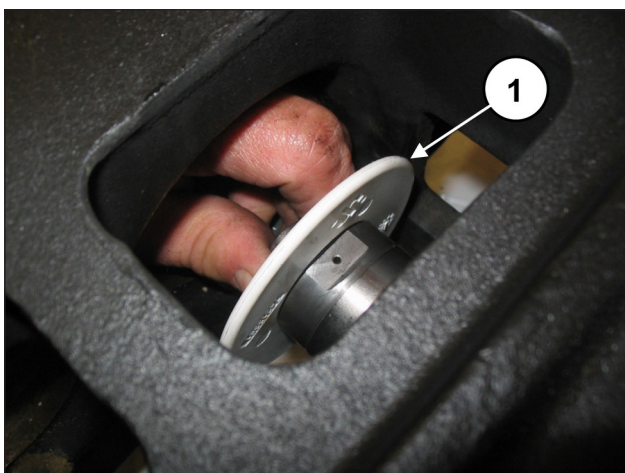

Fig. 135

Introducir la arandela $\text{Ø}10 \times 18 \times 0.9$ en el tornillo de fijación del pistón (pos. ①, Fig. 136).

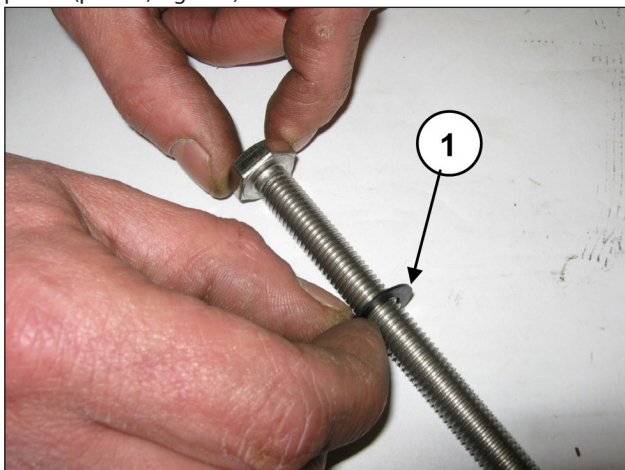

Fig. 136

Montar los pistones en las guías (pos. ①, Fig. 137) y extraerlos como se indica en la pos. ①, Fig. 138.

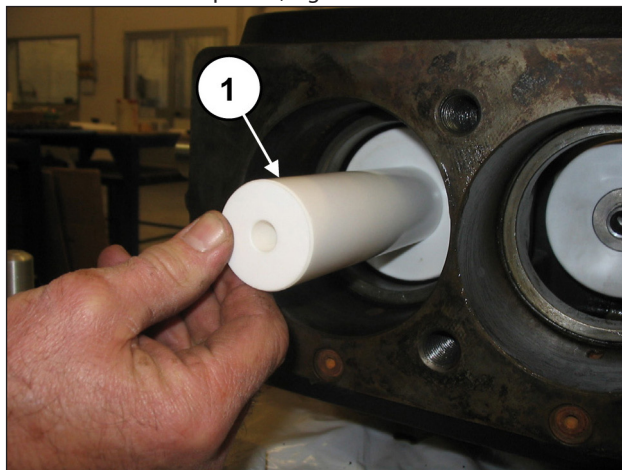

Fig. 137

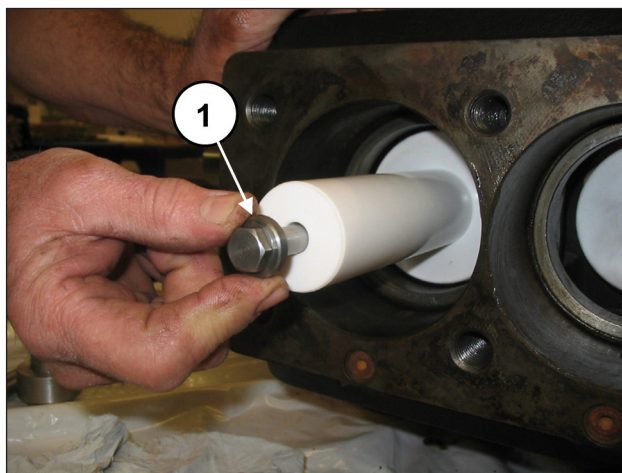

Fig. 138

Ajustar los tornillos con la llave dinamométrica como se indica en el capítulo 3.

Introducir la junta tórica en el cárter de la bomba (pos. ①, Fig. 139) y, a continuación, el bloque camisa-soporte junta (con la junta tórica) ya ensamblado (pos. ①, Fig. 140).

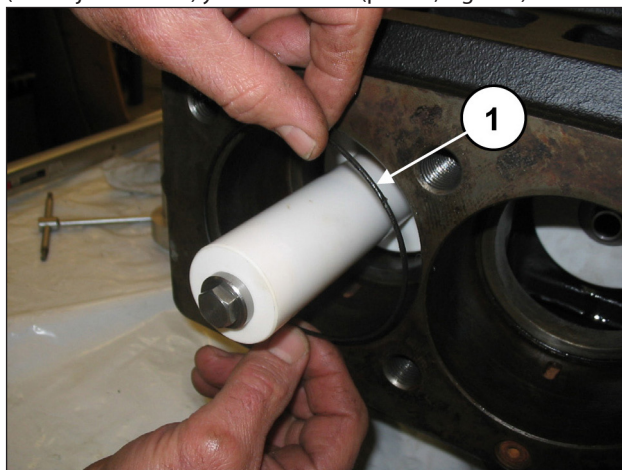

Fig. 139

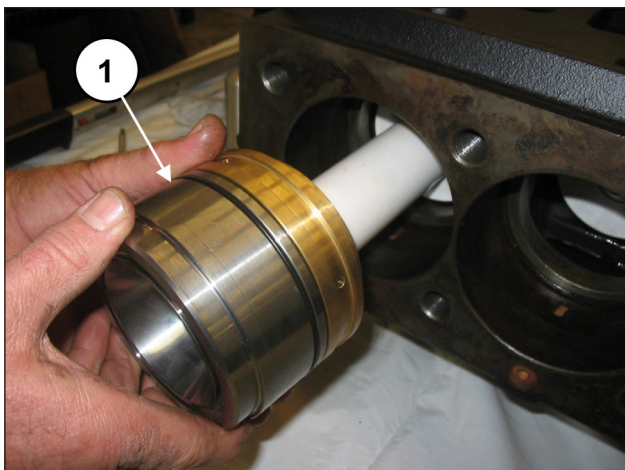

Fig. 140

Comprobar que el bloque camisa-soporte haga tope en el fondo del alojamiento (pos. ①, Fig. 141).

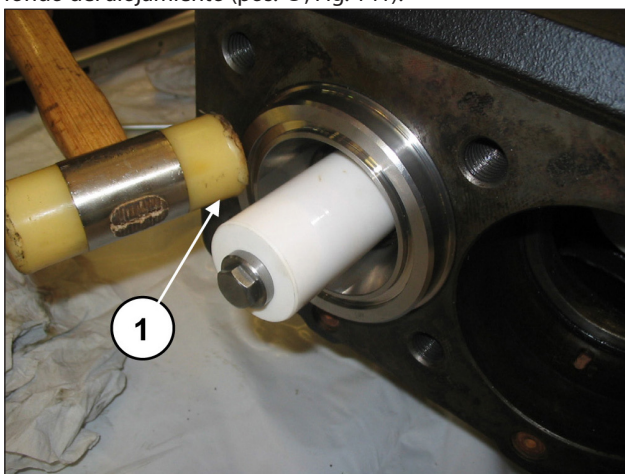

Fig. 141

Montar la junta tórica frontal de la camisa (pos. ①, Fig. 142) y la junta tórica del orificio de recirculación (pos. ①, Fig. 143).

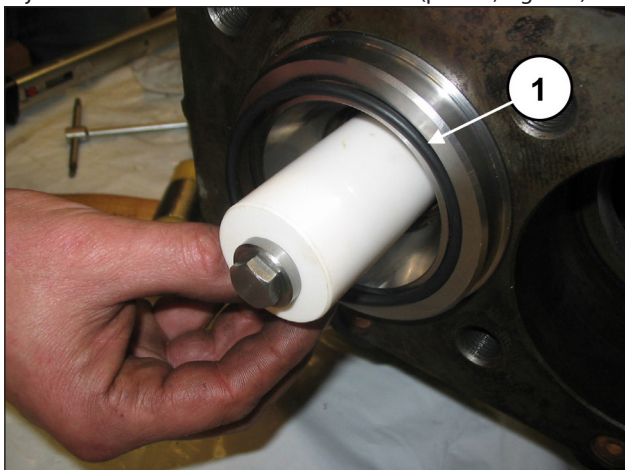

Fig. 142

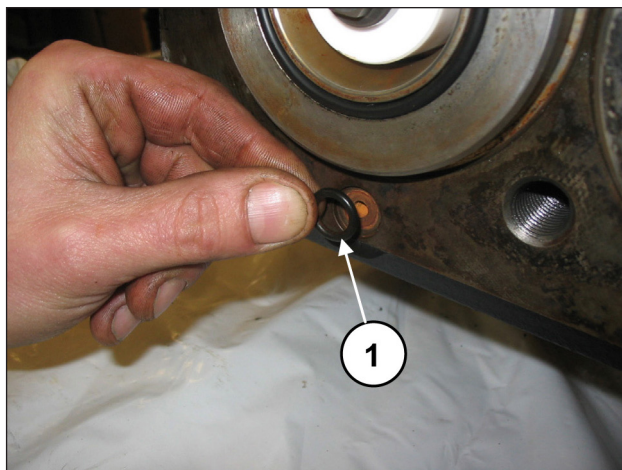

Fig. 143

Introducir la junta tórica (pos. ①, Fig. 144) en las tapas de inspección y montar las tapas con 4+4 tornillos M6x14 (pos. ①, Fig. 145).

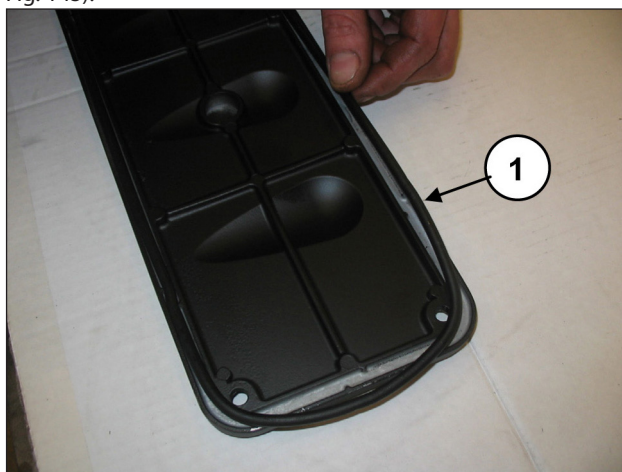

Fig. 144



Fig. 145

Ajustar los tornillos con la llave dinamométrica como se indica en el capítulo 3.

2.2.5 Recuperación de cabezas

Si la cabeza presenta dentro de las cámaras de los pistones signos evidentes de cavitación, provocados por una alimentación incorrecta de la bomba, es posible recuperar la cabeza dañada para no tener que sustituirla.

Para recuperar la cabeza se han de realizar los trabajos indicados en la Fig. 146 para las versiones con pistón Ø 40-45-50 y en la Fig. 147 para las versiones con pistón Ø 55-60-65:

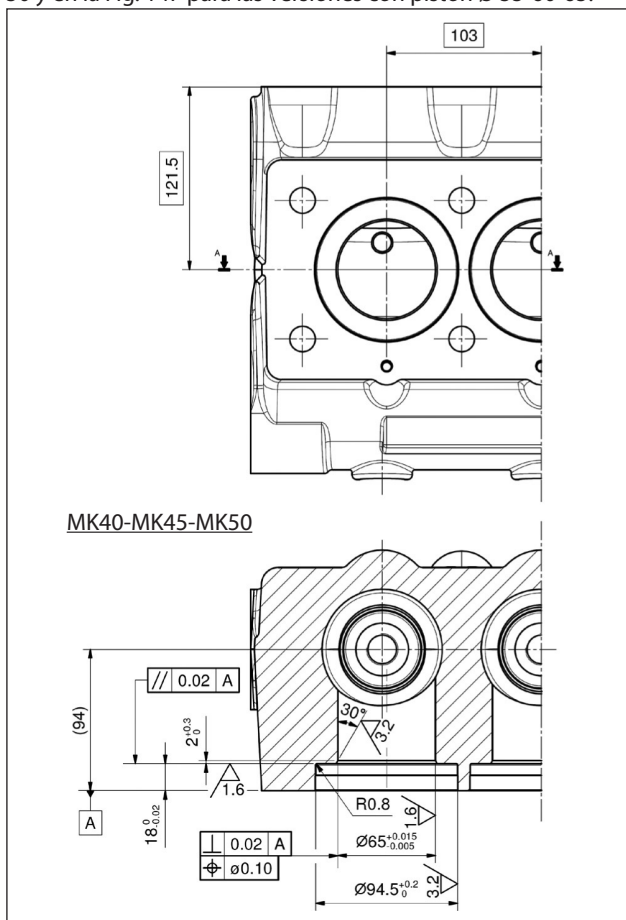

Fig. 146

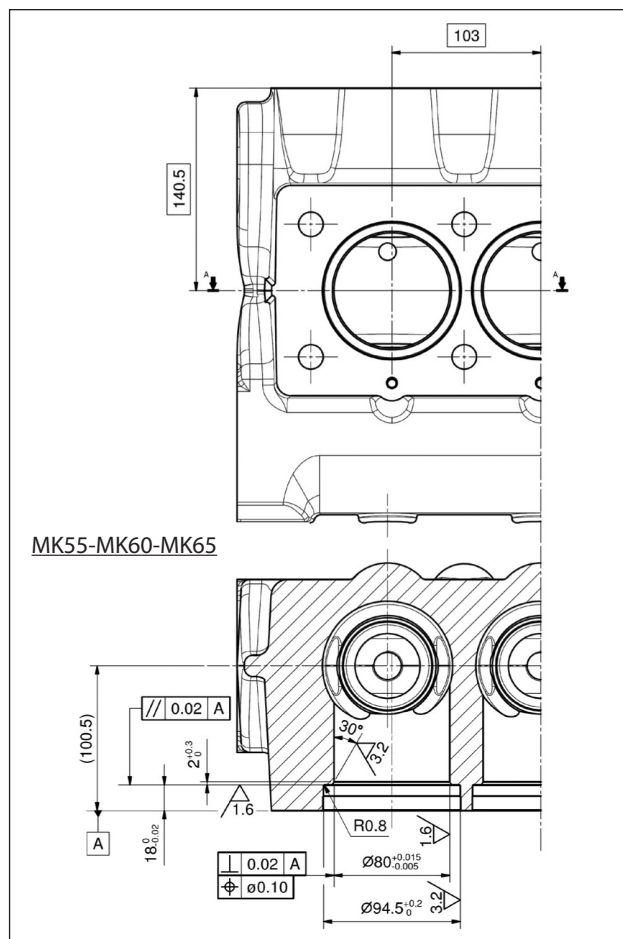

Fig. 147

La cabeza ya trabajada se ha de ensamblar mediante la introducción de los casquillos (pos. ①) con anillas anti extrusión (pos. ②) y las juntas tóricas (pos. ③) como muestra la Fig. 148 para las versiones con pistón Ø40-45-50 y en Fig. 149 para las versiones con pistón Ø 55-60-65:

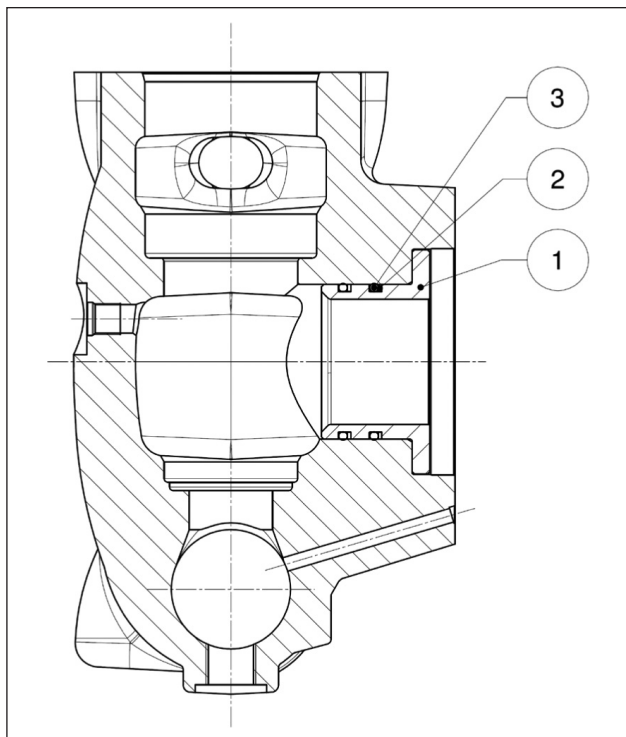

Fig. 148

- 1 - Casquillo para versiones con pistón de Ø 40-45-50 cód. 74215156 - cant. 3
- 2 - Anilla anti extrusión - cód. 90526880 - cant. 6
- 3 - Junta tórica - cód. 90410200 - cant.

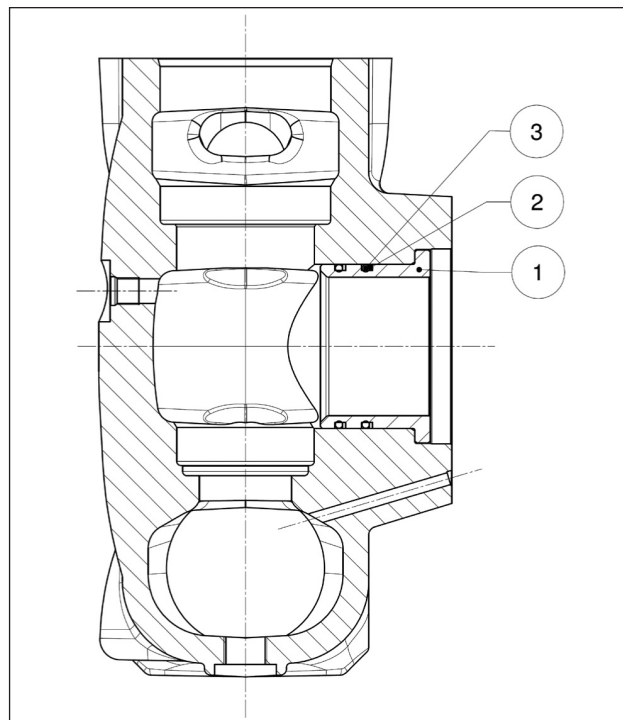

Fig. 149

- 1 - Casquillo en las versiones con pistón Ø 55-60-65 cód.74215056 - cant. 3
- 2 - Anilla anti extrusión - cód. 90528500 - cant. 6
- 3 - Junta tórica - cód. 90412900 - cant. 6

3 CALIBRACIÓN DE AJUSTE DE LOS TORNILLOS

El ajuste de los tornillos debe realizarse exclusivamente con una llave dinamométrica.

Descripción	Posición dibujo desglosado	Par de apriete Nm
Tornillo M8x18 de la tapa del cárter	54	20
Tapón G1/2x13 del cárter	55	40
Tornillo M8x18 de la brida del reductor	54	20
Tornillo M10x50 de la tapa del reductor	70	45
Tornillo M10x25 de tope de la corona	65	45
Tornillo M12x40 de la caja del reductor	75	73.5
Tornillo M12x50 de la caja del reductor	64	73.5
Tornillo M6x14 de las tapas superior e inferior	41	10
Tornillo M12x30 de la tapa del cojinete	90	40
Tornillo M12x1.25x87 de apriete de la biela	53	75*
Tornillo M6x20 de la guía del pistón	49	10
Tornillo M6x14 de la tapa de retención	41	10
Tornillo M10x160 de fijación del pistón	27	40
Tornillo M16x55 de la tapa de válvulas	26	333
Tapón G1/4"x13 cabeza	13	40
Tornillo M16x180 de la cabeza	25	333**
Dispositivo de apertura de las válvulas	2	40

* Ajustar el par de apriete atornillando los tornillos de modo simultáneo

** Apretar en diagonal los 4 tornillos internos (ver Fig. 108y a continuación los 4 externos).

4 HERRAMIENTAS DE REPARACIÓN

El mantenimiento de la bomba se puede llevar a cabo utilizando herramientas estándar para el montaje y el desmontaje de los componentes. Están disponibles las siguientes herramientas:

Para el montaje:

Retén guía pistón	cód. 27910900
Retén del piñón	cód. 27515900
	cód. 27548200
Junta del alojamiento de la válvula de envío de las versiones con pistón Ø 40-45-50.	cód. 27516000
Junta del alojamiento de la válvula de envío de las versiones con pistón Ø 55-60-65.	cód. 27516100

Para el desmontaje:

Alojamiento de la válvula de aspiración de las versiones con pistón Ø 40-45-50.	cód. 27516200
Alojamiento de la válvula de aspiración de las versiones con pistón Ø 55-60-65.	cód. 27516300
Alojamiento de la válvula de envío	cód. 27516400
Tapa del retén	cód. 27516400
	cód. 27516500
Bloque camisa + soporte de juntas	cód. 27516600
Tapa del reductor	cód. 27516700
Eje (bloqueo de las bielas)	cód. 27566200

5 SUSTITUCIÓN DEL CASQUILLO PIE DE LA BIELA

Realizar la conexión en frío del buje y los trabajos necesarios respetando las dimensiones y las tolerancias indicadas en la Fig. 150.

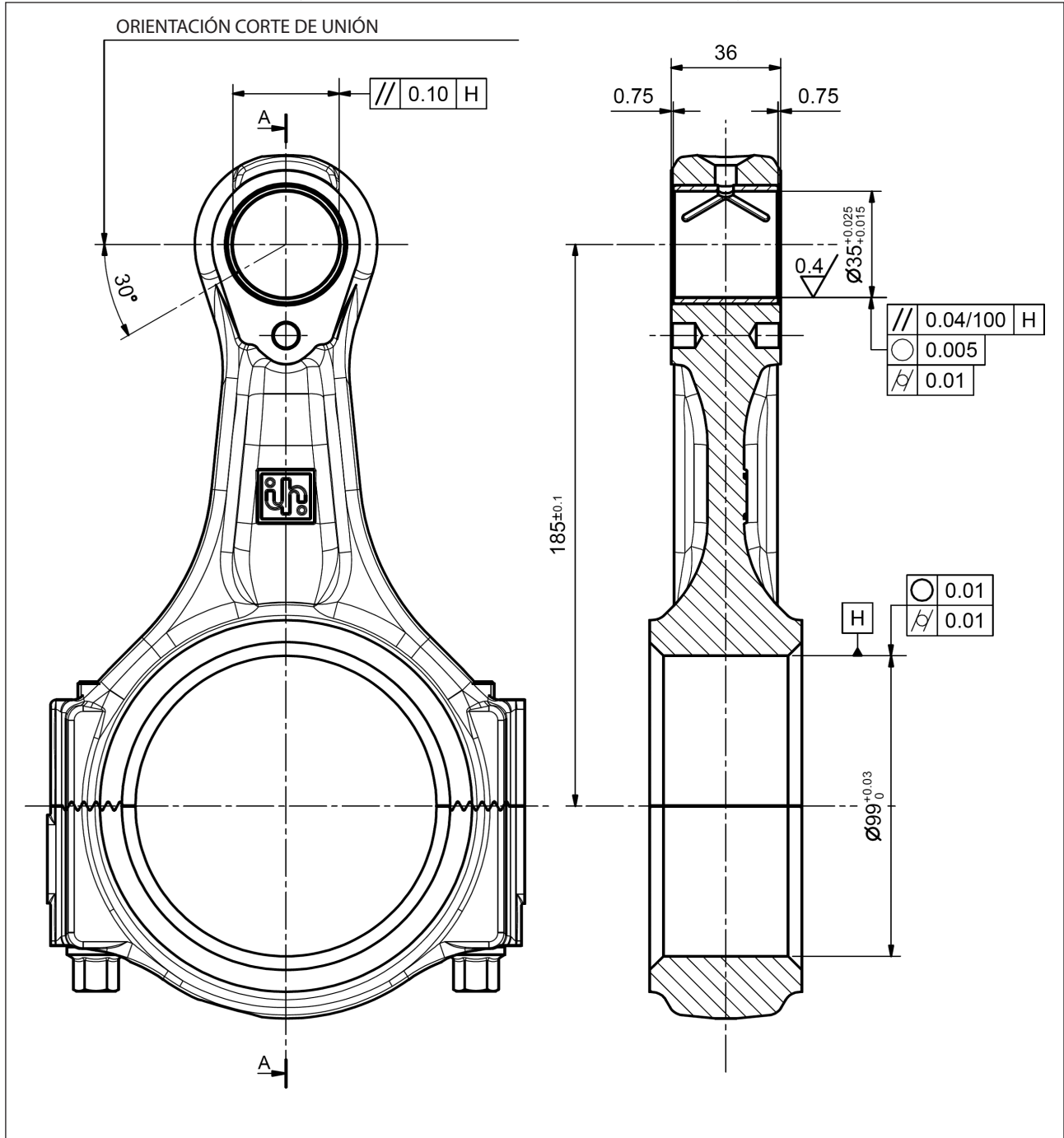

Fig. 150

6 VERSIONES ESPECIALES

A continuación se describe cómo reparar las versiones especiales. En los casos no especificados, respetar las instrucciones relativas a la versión de bomba MK-MKS estándar.

- Bombas MKC - MKSC: seguir las instrucciones de la bomba MK-MKS estándar.
- Bombas MKR - MKSR: seguir las instrucciones de la bomba MK estándar, excepto en el caso de las juntas de presión para las que es necesario respetar los apartados siguientes.

6.1 DESMONTAJE DEL GRUPO PISTÓN - SOPORTES - JUNTAS

Controlar el grupo del pistón de manera periódica como se indica en la tabla de mantenimiento preventivo del **Manual de uso y mantenimiento**.

Controlar de manera visual el drenaje del orificio de la tapa inferior. Si se detectan anomalías y oscilaciones en el manómetro de envío o pérdidas por el orificio de drenaje, controlar y sustituir el paquete de juntas.

Para extraer los grupos de pistón operar del siguiente modo: Para acceder al grupo de pistón, es necesario aflojar los tornillos M16x180 y desmontar la cabeza.



Extraer la cabeza con cuidado para no golpear los pistones.

Desmontar los pistones aflojando los tornillos de fijación (pos. ①, Fig. 151).

Extraer el pistón del soporte de juntas y comprobar que su superficie no esté rayada ni presente signos de desgaste o cavitación.

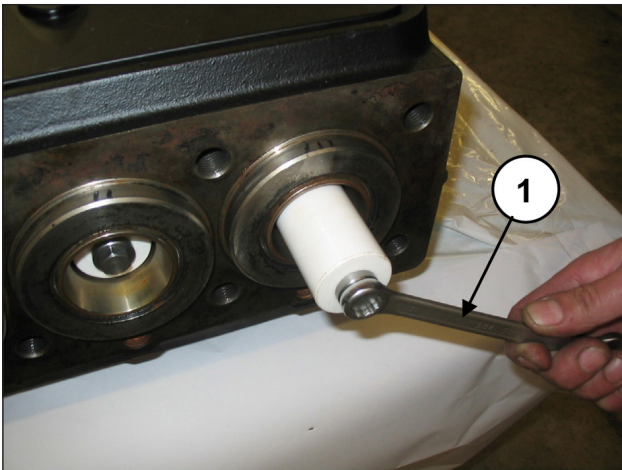

Fig. 151

Quitar la tapa de inspección superior aflojando los 4 tornillos de fijación (pos. ①, Fig. 152).

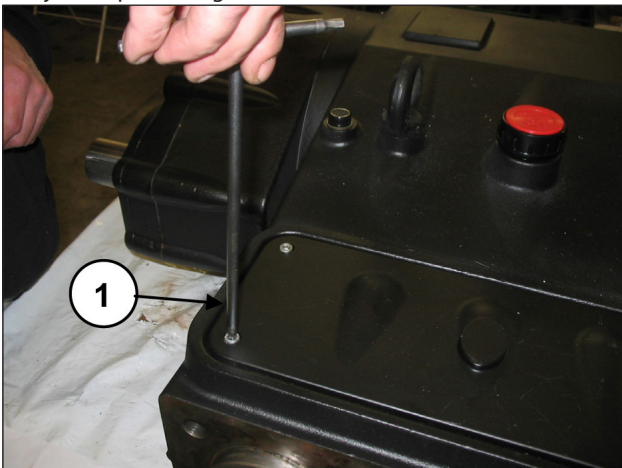

Fig. 152

Girar a mano el eje para desplazar progresivamente los 3 pistones hacia la posición de punto muerto superior e introducir la herramienta tampón cód. 27516600 entre la guía del pistón y el pistón (pos. ①, Fig. 153).

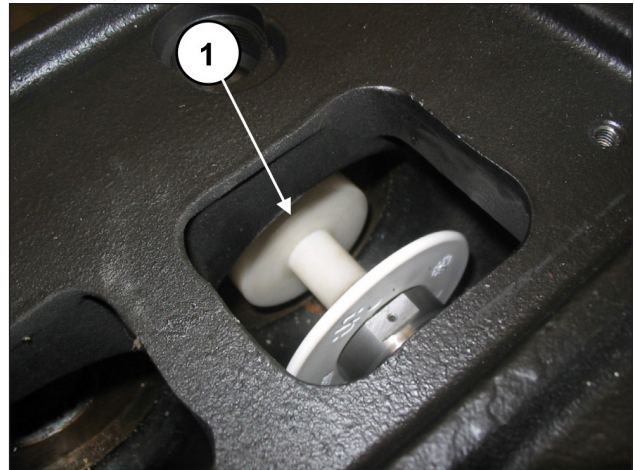

Fig. 153

Girar el eje para desplazar la guía del pistón de manera que el tampón avance y expulse el soporte de las juntas, el muelle y el grupo del pistón completo (pos. ①, Fig. 154).

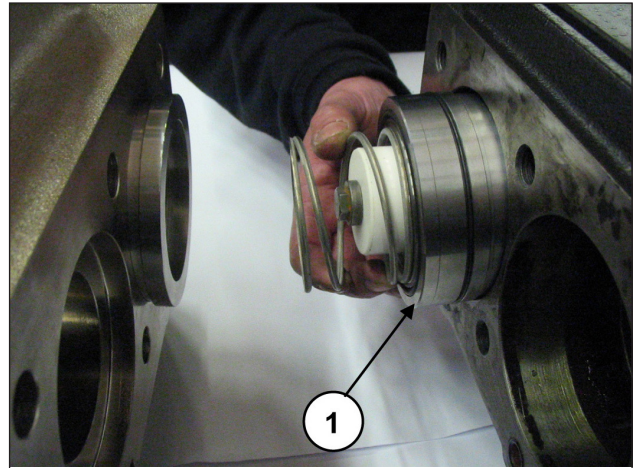

Fig. 154

Extraer el grupo de soporte de las juntas y la herramienta tampón.

Extraer la junta tórica del fondo del soporte de la junta si se queda dentro del cárter de la bomba (pos. ①, Fig. 155).

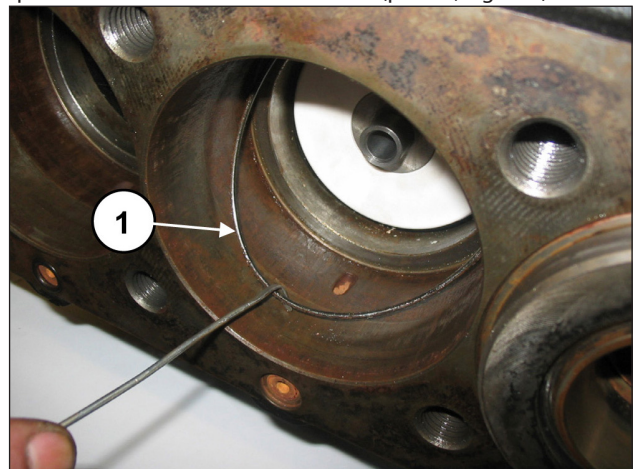

Fig. 155

Extraer de las guías de los pistones las anillas de protección contra las salpicaduras (pos. ①, Fig. 156).

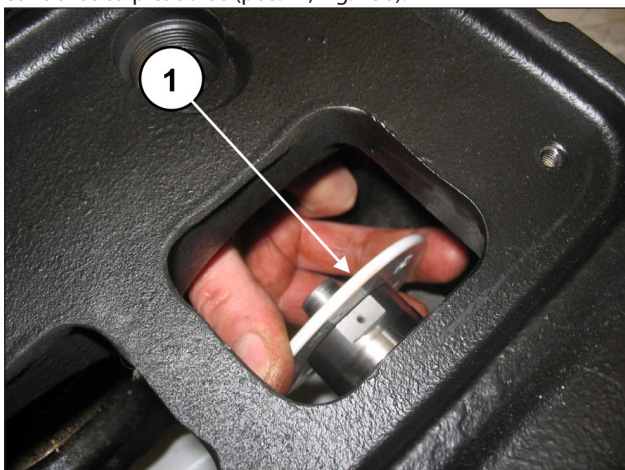

Fig. 156

Si es necesario sustituir el retén de la guía del pistón, desmontar la tapa de retención como se indica a continuación: Aflojar los 2 tornillos de bloqueo de la tapa de retención (pos. ①, Fig. 157).

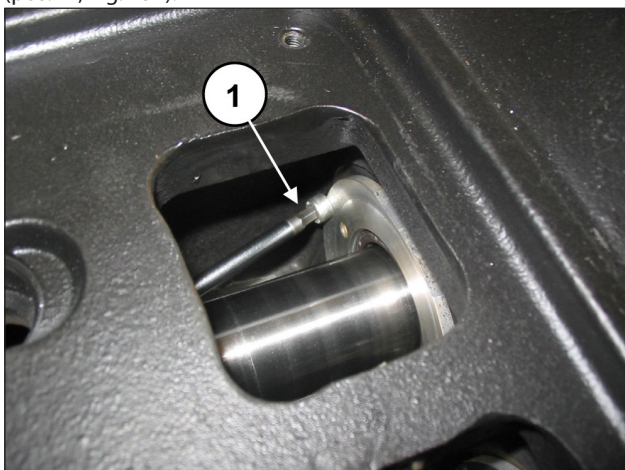

Fig. 157

Colocar la guía del pistón en el punto muerto inferior, enroscar el extractor cód. 27516400 junto con el adaptador M5 cód. 27516500 en los orificios de la tapa (pos. ①, Fig. 158) y extraer la tapa de retención del grupo de la bomba (pos. ①, Fig. 159).

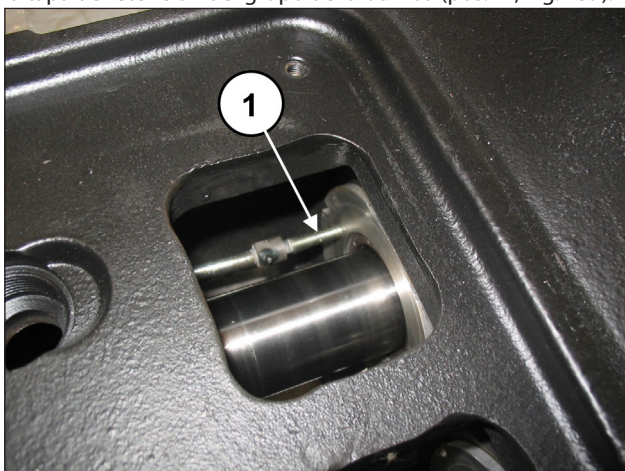

Fig. 158



Fig. 159

Sustituir el retén (pos. ①, Fig. 160) y la junta tórica externa (pos. ②, Fig. 160).

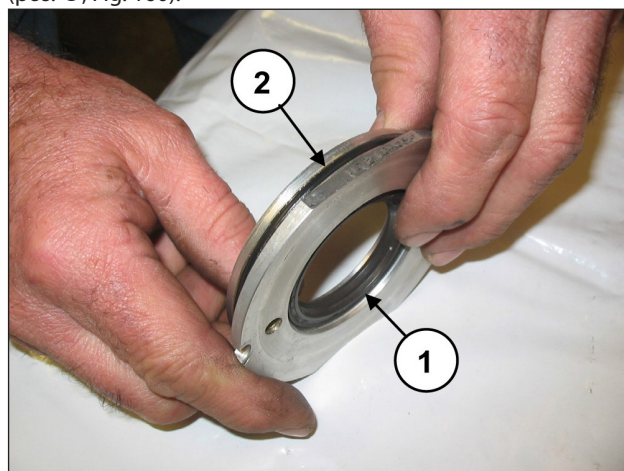

Fig. 160

Separar el soporte de juntas de la camisa, desmontar la anilla del muelle y la anilla de retén (pos. ①②, Fig. 161) para acceder a las juntas de presión (pos. ①, Fig. 162).

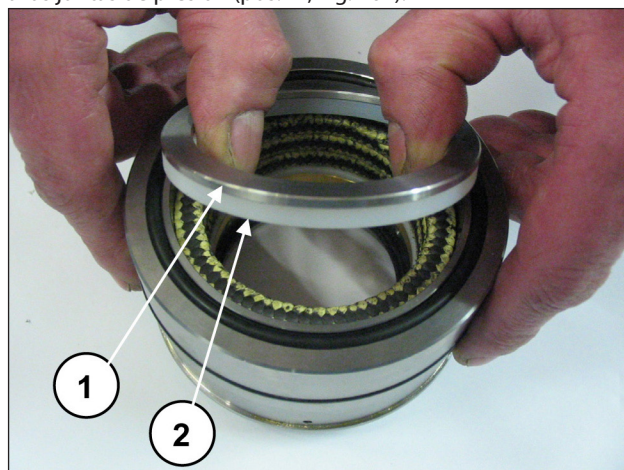

Fig. 161

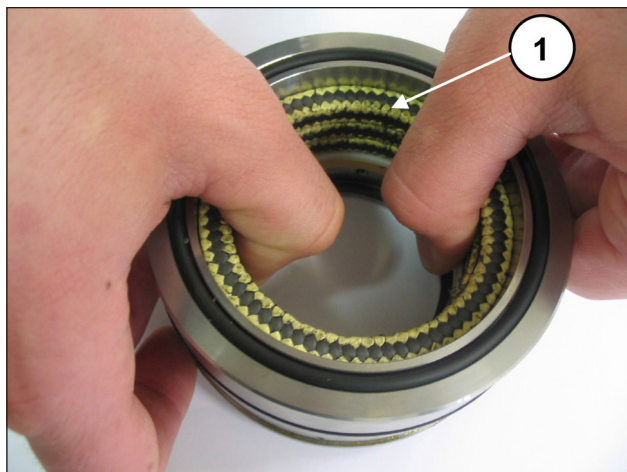

Fig. 162

Para quitar la junta de baja presión, es necesario utilizar un espesímetro o una herramienta que no dañe el alojamiento del soporte de la junta (pos. ①, Fig. 163).



Fig. 163

6.2 MONTAJE DEL GRUPO PISTÓN - SOPORTES - JUNTAS

Seguir en orden contrario la secuencia de desmontaje descrita en el apart. 6.1.



Sustituir las juntas de presión, para ello humedecer los labios con grasa de silicona (sin esparcir) e introducir las en la camisa con cuidado para no dañarlas.



Sustituir las juntas de presión y las juntas tóricas cada vez que se realicen operaciones de desmontaje.

Introducir la junta de baja presión en el soporte de las arandelas de prensaestopas (pos. ①, Fig. 164), controlando el sentido de montaje (el labio de retención debe estar hacia adelante, hacia el cabezal), y la junta tórica (pos. ②, Fig. 164).

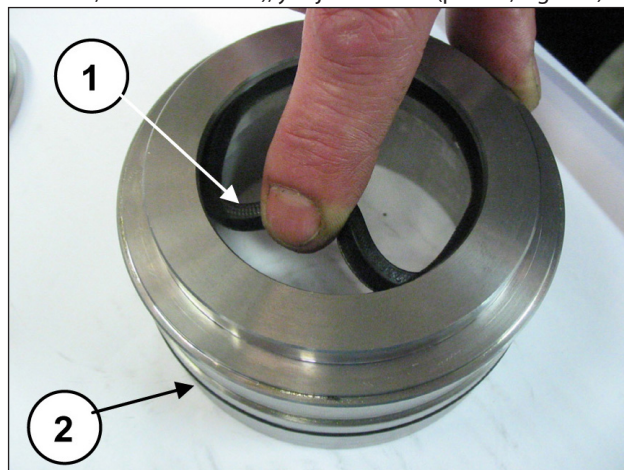

Fig. 164

Montar la anilla de soporte y la anilla anti extrusión (pos. ①②, Fig. 165), las tres arandelas de prensaestopas de manera que las incisiones se encuentren a 120° entre sí (pos. ①, Fig. 166), el retén de las arandelas de prensaestopas y la anilla del muelle (pos. ①②, Fig. 167).

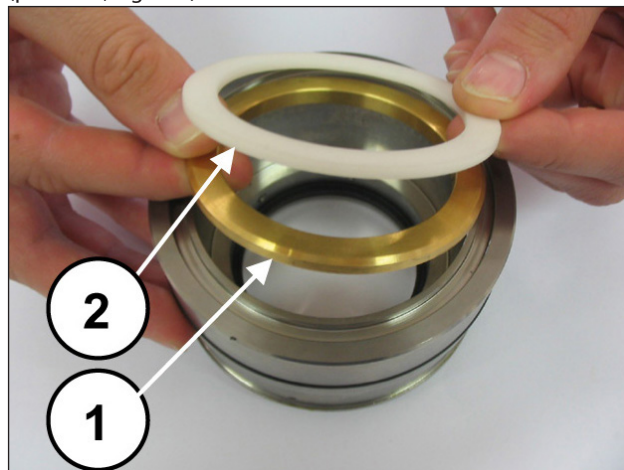

Fig. 165

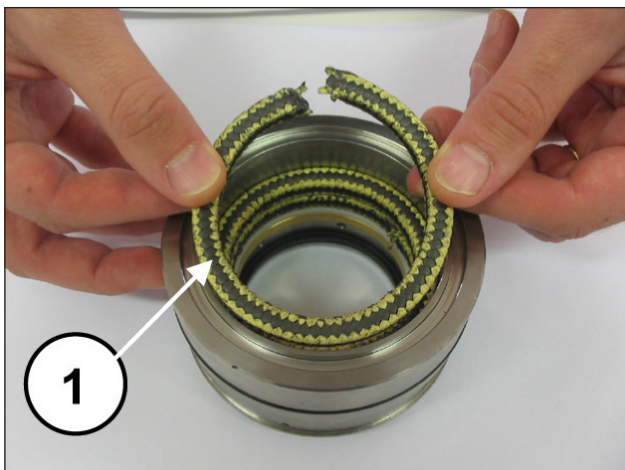

Fig. 166

Montar el retén en la tapa de retención (pos. ①, Fig. 169) utilizando un tampón cód. 27910900.

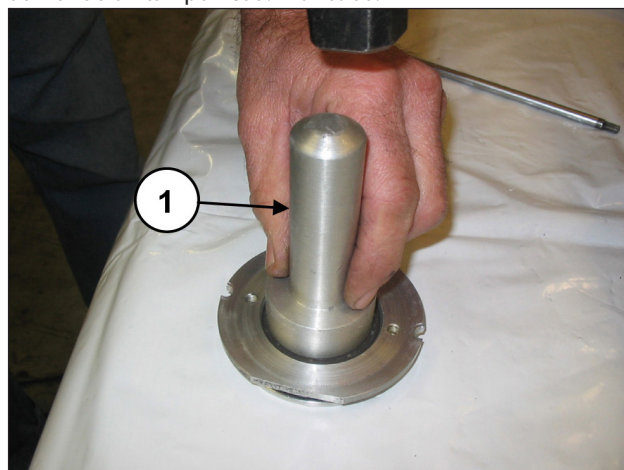

Fig. 169

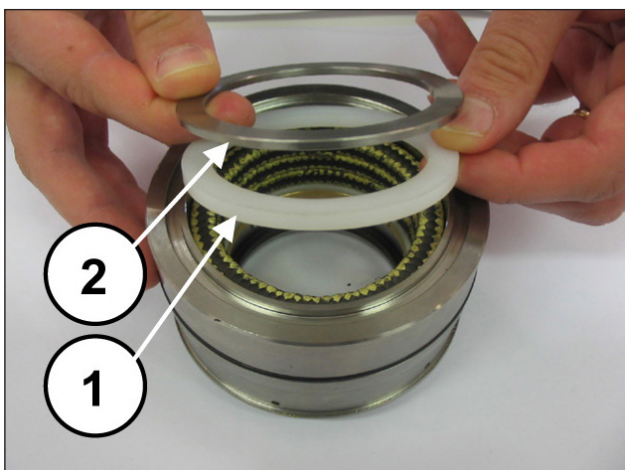

Fig. 167

Colocar la junta tórica (pos. ①, Fig. 170) en el alojamiento de la tapa de retención e introducir el grupo montado dentro del cárter en el alojamiento específico (pos. ①, Fig. 171).

Montar en la anilla del cuello de las arandelas de prensaestopas la junta tórica (pos. ①, Fig. 168) y colocarla en el alojamiento de la cabeza.

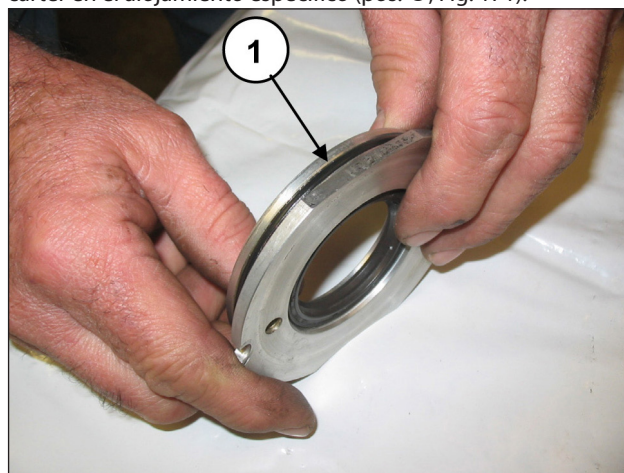

Fig. 170



Fig. 168

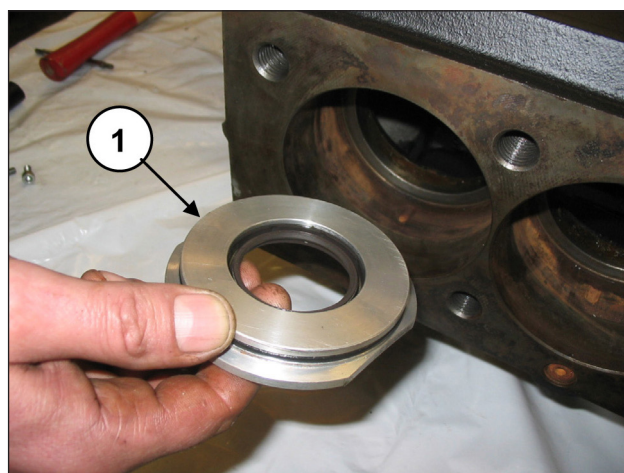

Fig. 171

Comprobar que la tapa entre a fondo en el alojamiento (pos. ①, Fig. 172). No dañar el labio del retén. Fijar las tapas de retención con 2 tornillos M6x14 (pos. ①, Fig. 173).

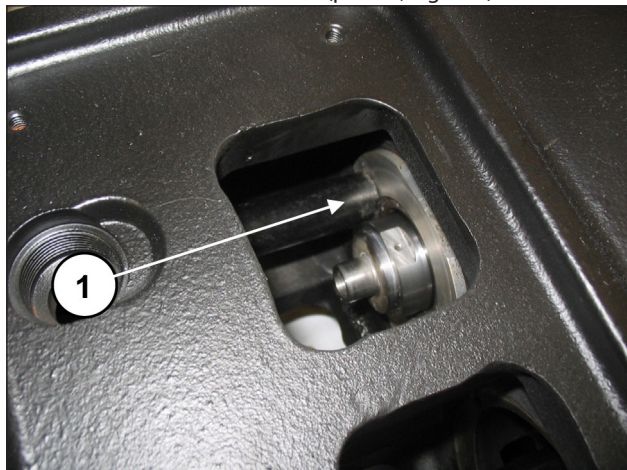

Fig. 172

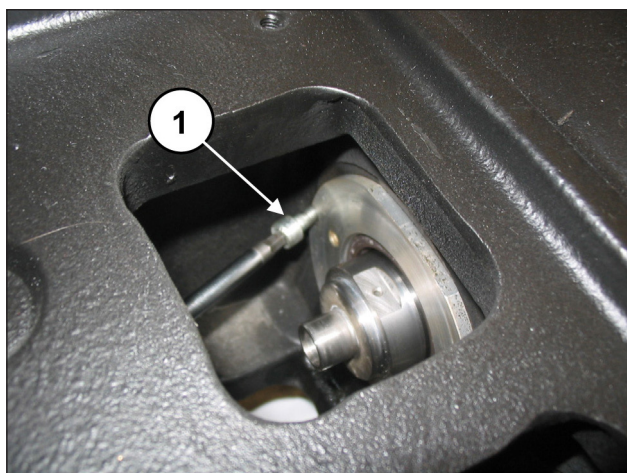

Fig. 173

Ajustar los tornillos con la llave dinamométrica como se indica en el capítulo 3.

Colocar los protectores contra salpicaduras junto con las juntas tóricas en el alojamiento de la guía del pistón (pos. ①, Fig. 174 y Fig. 175).

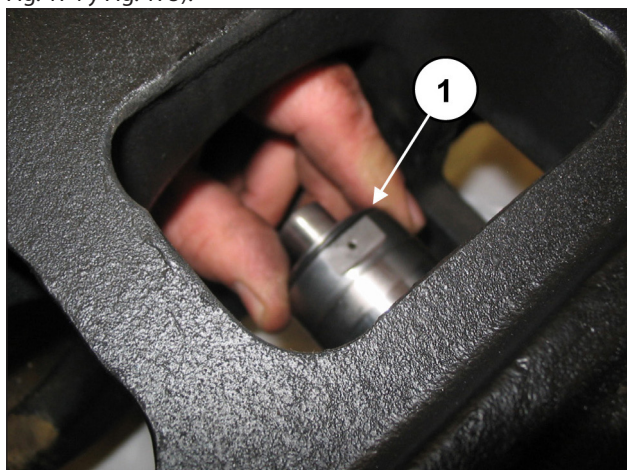

Fig. 174

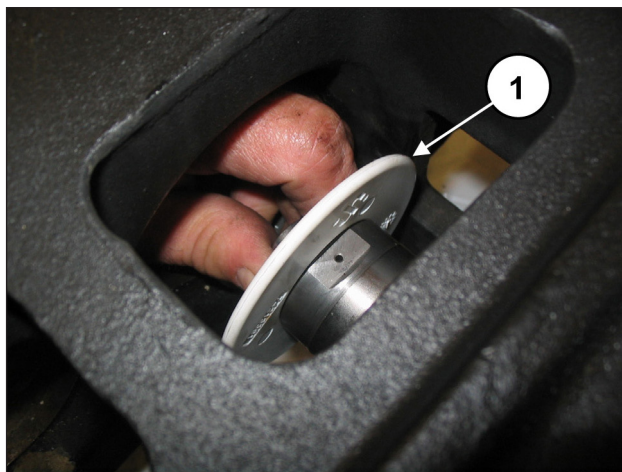

Fig. 175

Introducir la arandela Ø10x18x0.9 en el tornillo de fijación del pistón (pos. ①, Fig. 176).

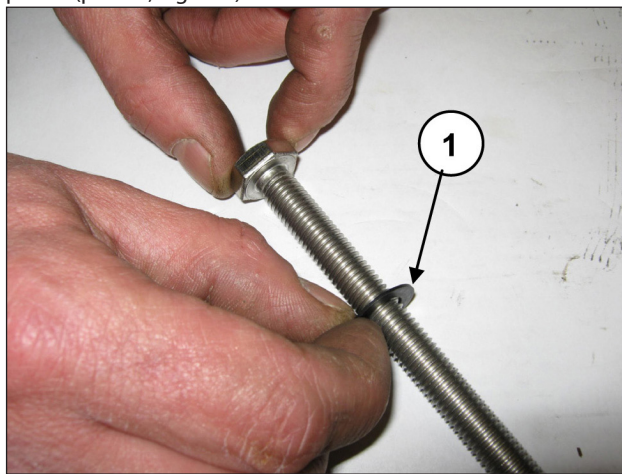

Fig. 176

Montar los pistones en las guías (pos. ①, Fig. 177) y extraerlos como se indica en la pos. ①, Fig. 178.

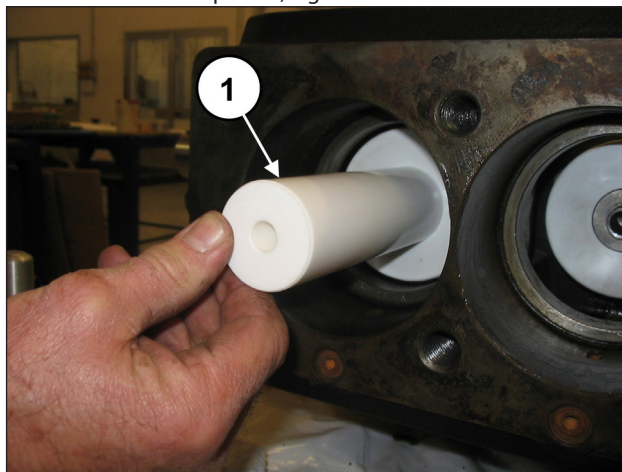

Fig. 177

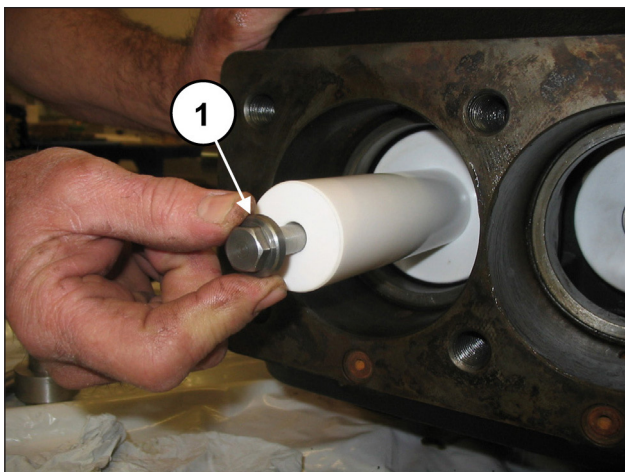

Fig. 178

Ajustar los tornillos con la llave dinamométrica como se indica en el capítulo 3.

Introducir la junta tórica en el cárter de la bomba (pos. ①, Fig. 179) y, a continuación, el bloque camisa-soporte junta (con la junta tórica) ya ensamblado (pos. ①, Fig. 180).



Fig. 179

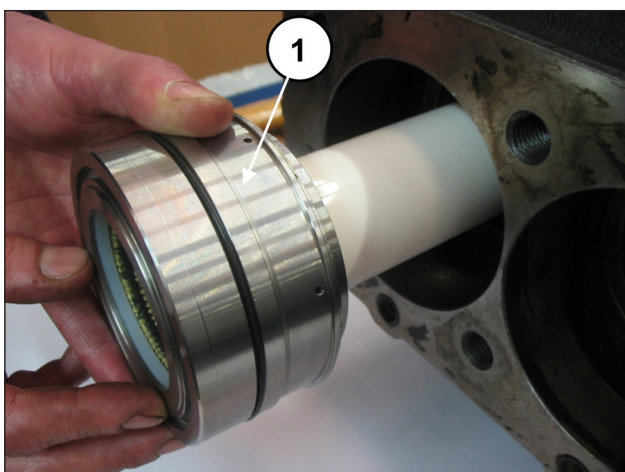

Fig. 180

Comprobar que el bloque camisa-soporte haga tope en el fondo del alojamiento (pos. ①, Fig. 181) y, a continuación, montar la junta tórica frontal de la camisa y el muelle (pos. ①②, Fig. 182).

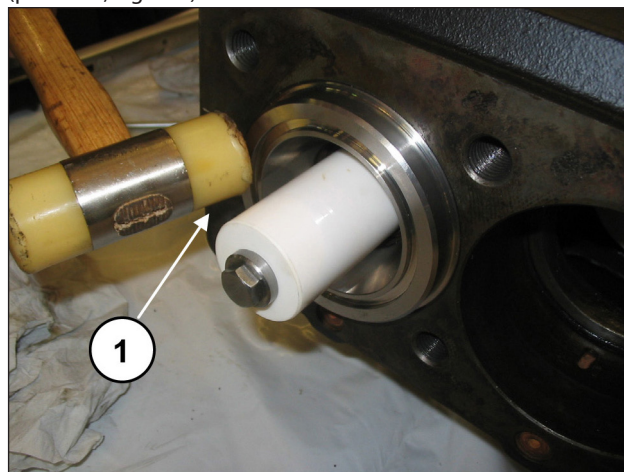

Fig. 181

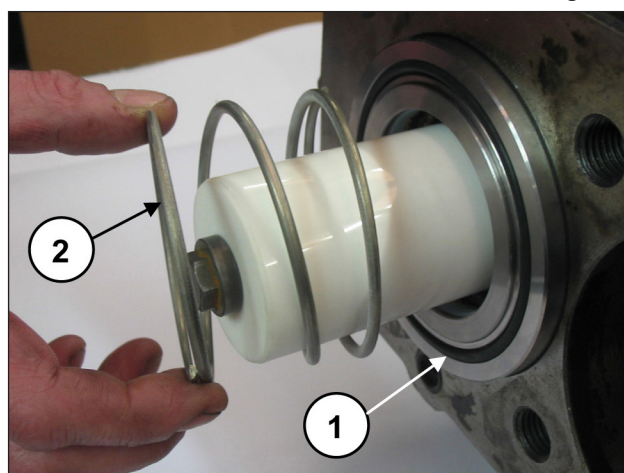

Fig. 182

Montar la junta tórica del orificio de recirculación (pos. ①, Fig. 183).

Aplicar una ligera capa de grasa para facilitar la introducción de las juntas tóricas en los alojamientos. La Fig. 184 muestra el montaje del cabezal.

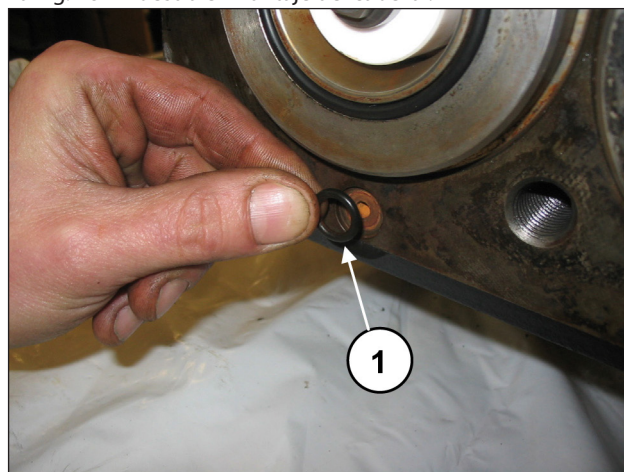

Fig. 183

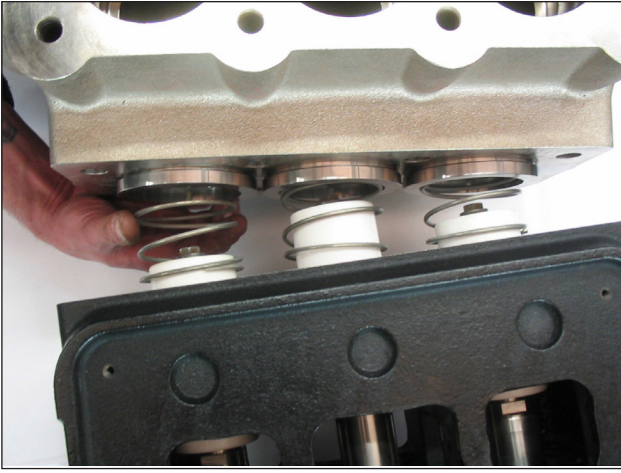

Fig. 184

Introducir la junta tórica (pos. ①, Fig. 185) en las tapas de inspección y montar las tapas con 4+4 tornillos M6x14 (pos. ①, Fig. 186).

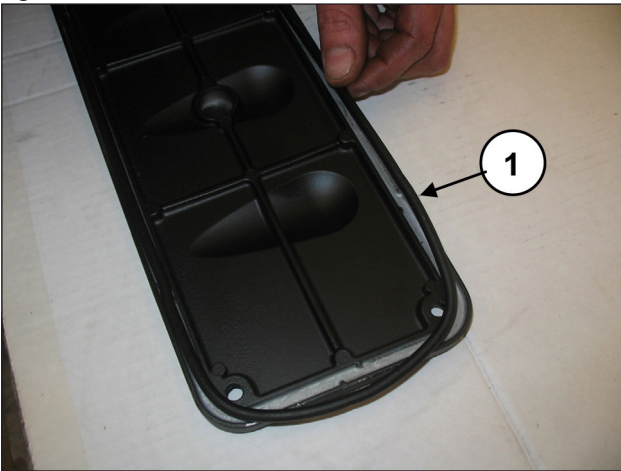

Fig. 185

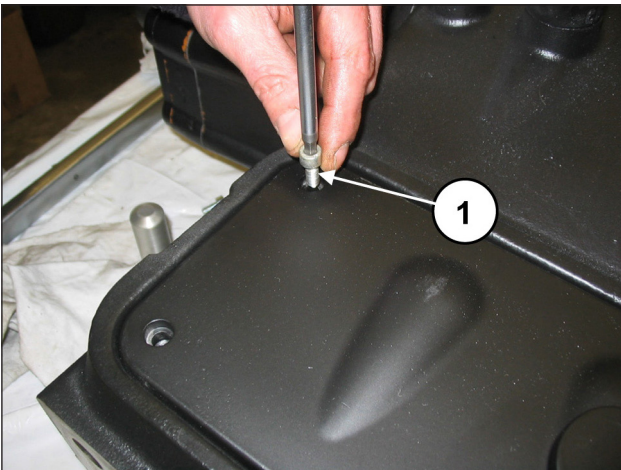

Fig. 186

Ajustar los tornillos con la llave dinamométrica como se indica en el capítulo 3.

Resumo

1	INTRODUÇÃO	192
1.1	DESCRIÇÕES DOS SÍMBOLOS.....	192
2	NORMAS DE REPARAÇÃO	192
2.1	REPARAÇÃO DA PARTE MECÂNICA.....	192
2.1.1	<i>Desmontagem da parte mecânica</i>	192
2.1.2	<i>Montagem da parte mecânica</i>	198
2.1.3	<i>Classes de aumento previstas</i>	205
2.2	REPARAÇÃO DA PARTE HIDRÁULICA	206
2.2.1	<i>Desmontagem do cabeçote - grupos da válvula</i>	206
2.2.2	<i>Montagem do cabeçote - grupos da válvula</i>	207
2.2.3	<i>Desmontagem do grupo do pistão - suportes - vedação</i>	211
2.2.4	<i>Montagem do grupo do pistão - suportes - vedação</i>	214
2.2.5	<i>Recuperação dos cabeçotes</i>	218
3	CALIBRAGEM DO APERTO DOS PARAFUSOS	219
4	FERRAMENTAS PARA A REPARAÇÃO	220
5	SUBSTITUIÇÃO DA BUCHA DO PÉ DA HASTE	221
6	VERSÕES ESPECIAIS	222
6.1	DESMONTAGEM DO GRUPO DO PISTÃO - SUPORTES - VEDAÇÃO	222
6.2	MONTAGEM DO GRUPO DO PISTÃO - SUPORTES - VEDAÇÃO.....	224

1 INTRODUÇÃO

Este manual descreve as instruções para a reparação das bombas da família MK e deve ser atentamente lido e compreendido antes de realizar qualquer intervenção na bomba.

O uso correto e manutenção adequada depende do funcionamento e duração regular da bomba.

A Interpump Group não se responsabiliza por qualquer dano causado por mau uso ou pelo não cumprimento das regras descritas neste manual.

1.1 DESCRIÇÕES DOS SÍMBOLOS

Leia atentamente as instruções contidas neste manual antes de qualquer operação.



Sinal de Advertência



Leia atentamente as instruções contidas neste manual antes de qualquer operação.



Sinal de Perigo

Use óculos de proteção.



Sinal de Perigo

Use luvas de proteção antes de cada operação.

2 NORMAS DE REPARAÇÃO



2.1 REPARAÇÃO DA PARTE MECÂNICA

As operações de reparação da parte mecânica devem ser realizadas depois de ter removido o óleo do carter.

Para retirar o óleo, é preciso remover a tampa de carga do óleo pos. ①, Fig. 1 e em seguida, a tampa de descarga pos. ②, Fig. 1.

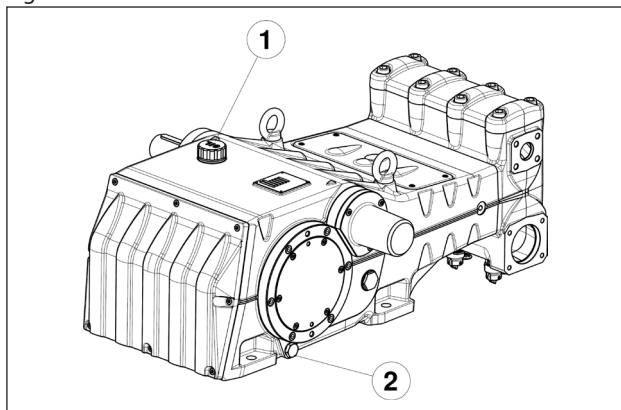

Fig. 1



O óleo esgotado deve ser colocado em um recipiente adequado e disposto em centrais adequadas.

Não deve ser, de forma nenhuma, disposto no meio ambiente.

2.1.1 Desmontagem da parte mecânica

A sequência correta é a seguinte:

Esvazie completamente o óleo da bomba, em seguida, remova a lingueta do eixo (pos. ①, Fig. 2).



Fig. 2

Solte os parafusos de fixação da flange do redutor (pos. ①, Fig. 3) e remova a flange do eixo.

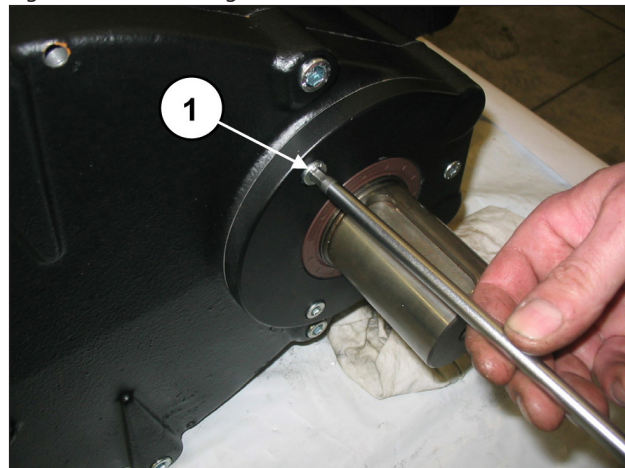

Fig. 3

No lado oposto, solte os parafusos de fixação da cobertura do rolamento (pos. ①, Fig. 4) e remova-o.

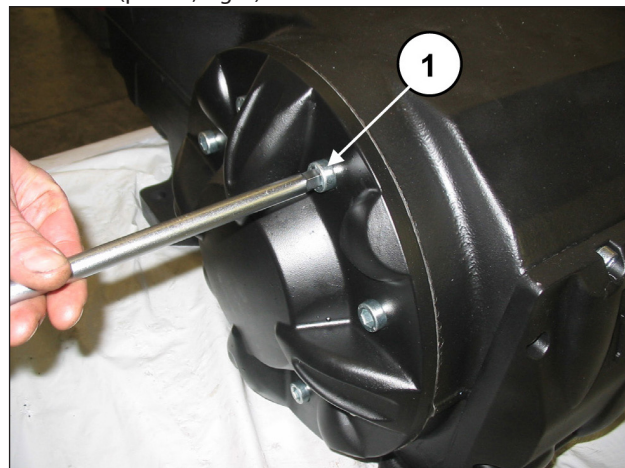

Fig. 4

Realize agora a desmontagem da cobertura do carter, soltando os parafusos relativos (pos. ①, Fig. 5).

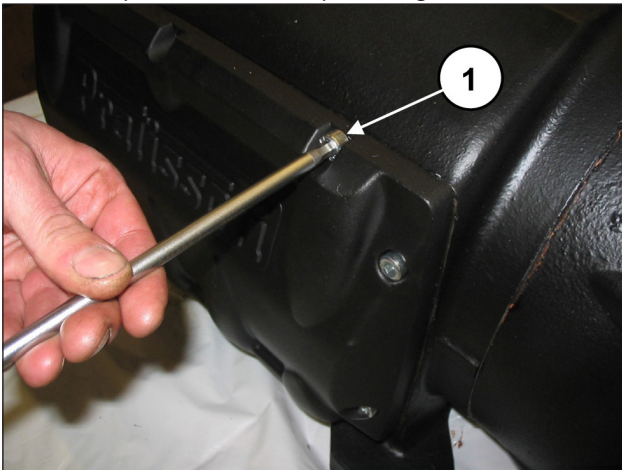

Fig. 5

Solte os parafusos de fixação da cobertura do redutor (pos. ①, Fig. 6).

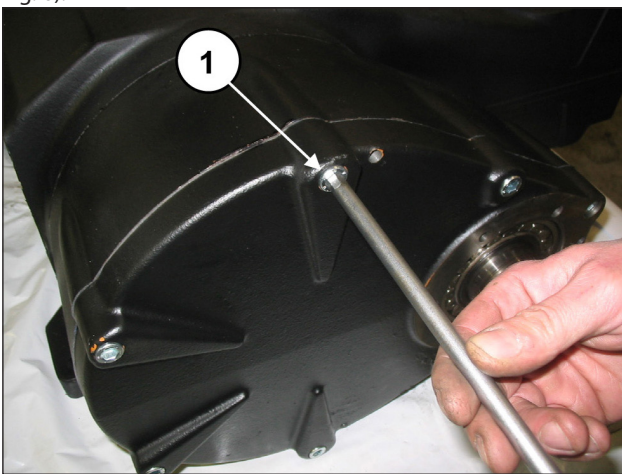

Fig. 6

Posicione três grãos ou parafusos rosqueados M8 (pos. ①, Fig. 7) com a função de extrator nos furos especiais e dois parafusos M10, suficientemente longos, com a função de sustentar a cobertura (pos. ②, Fig. 7).

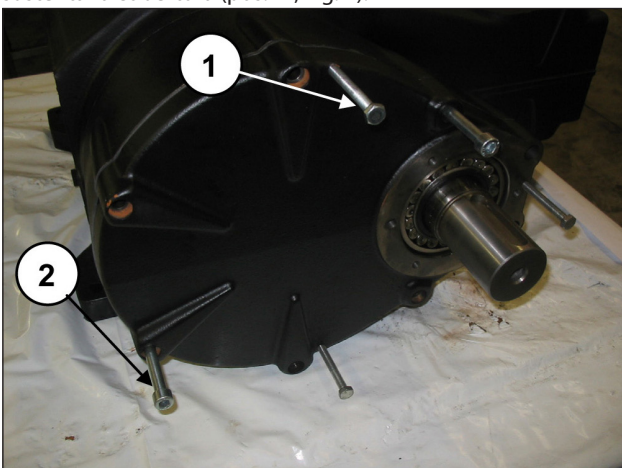

Fig. 7

Aperte os três grãos rosqueados (pos. ①, Fig. 8), com a função de extrator e, simultaneamente, usando a ferramenta adequada (cód. 27516700), bata no mesmo, de modo que o rolamento permaneça no pinhão durante a extração da cobertura (pos. ①, Fig. 9).

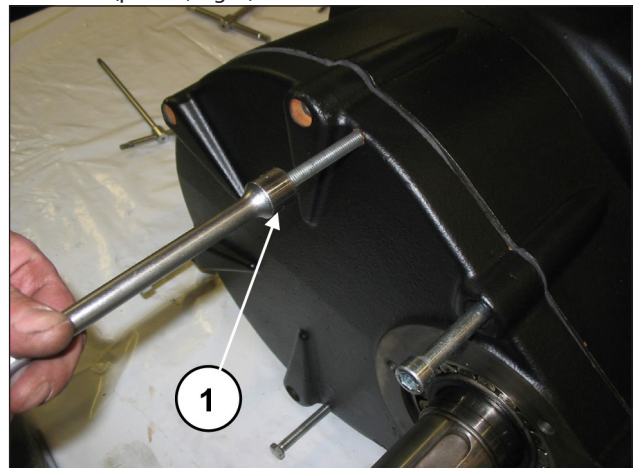

Fig. 8

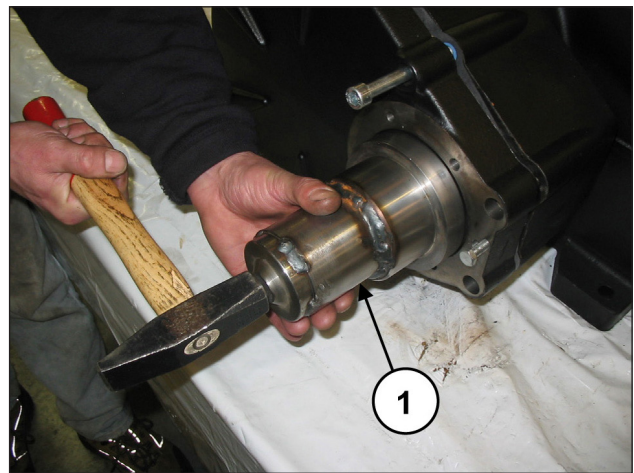

Fig. 9

Com a operação finalizada, remova a cobertura do redutor e, em seguida, remova o rolamento do pinhão. Solte os parafusos que fixam a retenção da coroa (pos. ①, Fig. 10) e remova-os (pos. ①, Fig. 11).

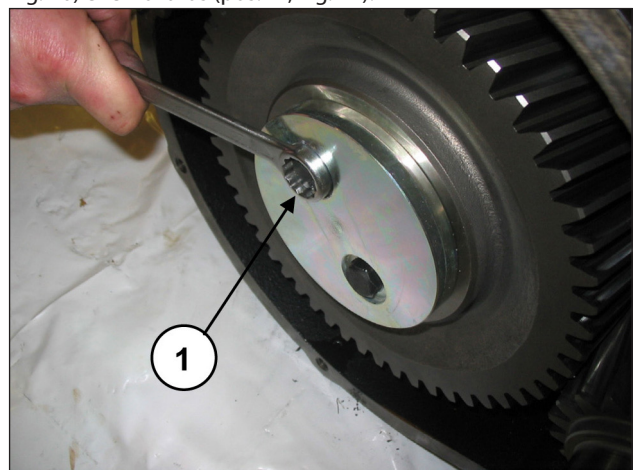

Fig. 10

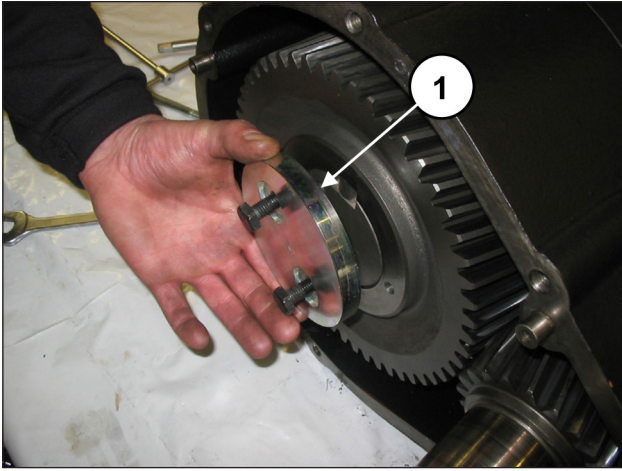

Fig. 11

Retire a coroa (pos. ①, Fig. 12). Se necessário, é possível usar um extrator de mecanismo de percussão para aplicar os dois furos M8 (pos. ②, Fig. 12).

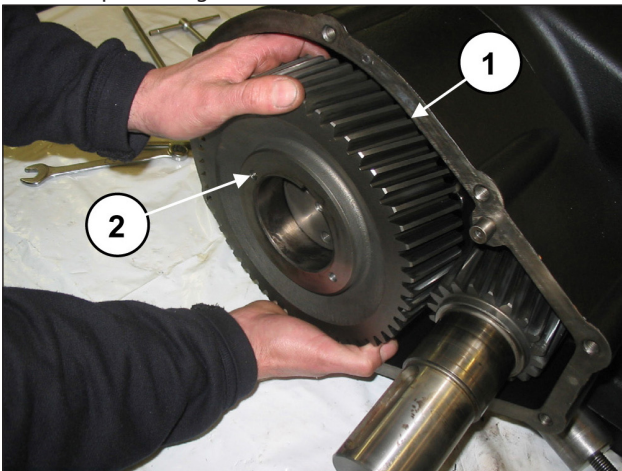

Fig. 12

Retire a lingueta do eixo (pos. ①, Fig. 13).

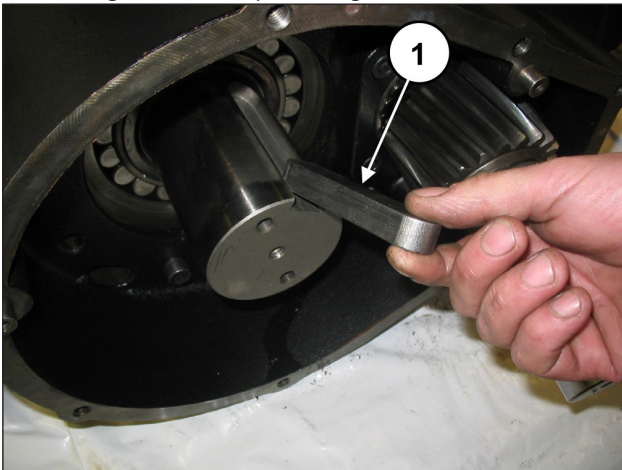

Fig. 13

Retire o pinhão, usando um extrator do mecanismo de percussão, para aplicar o furo M14 (pos. ①, Fig. 14).

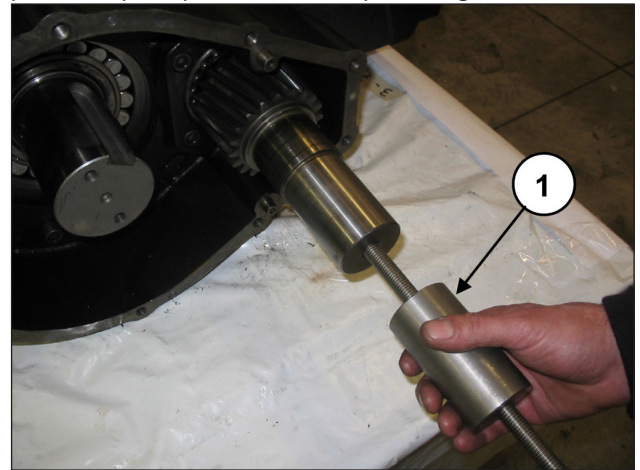

Fig. 14

Eleve a lingueta da arruela de segurança (pos. ①, Fig. 15).

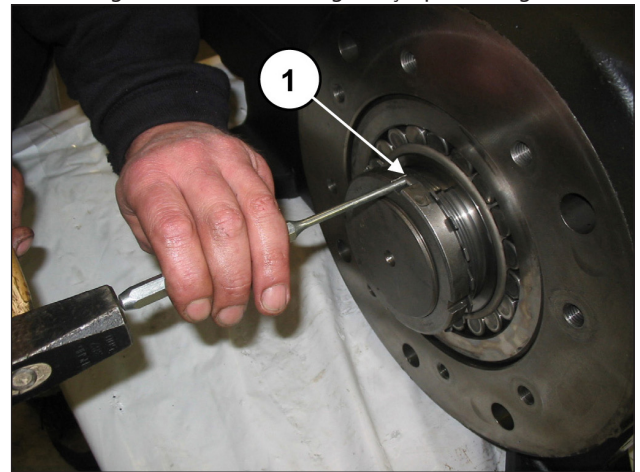

Fig. 15

Insira uma espessura abaixo da haste para bloquear a rotação do eixo (pos. ①, Fig. 16).

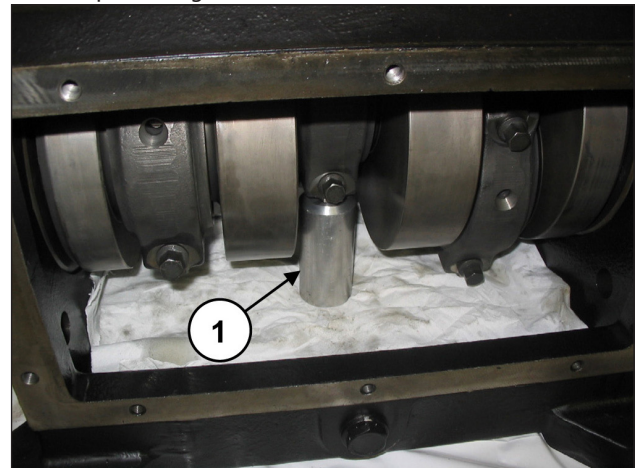

Fig. 16

Usando uma chave adequada, solte o anel de bloqueio (pos. ①, Fig. 17), depois remova o anel e a arruela de segurança (pos. ①, Fig. 18).

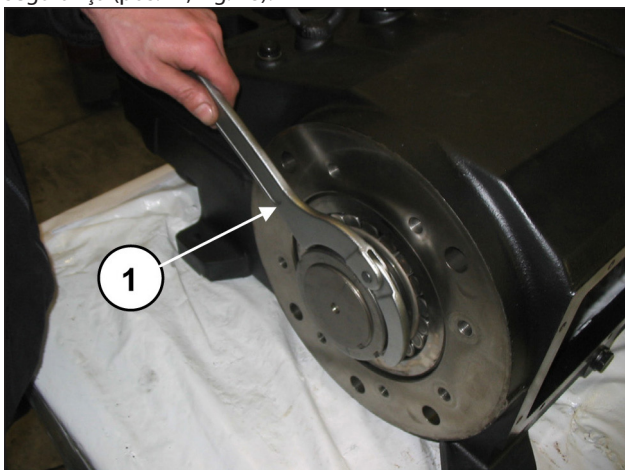

Fig. 17

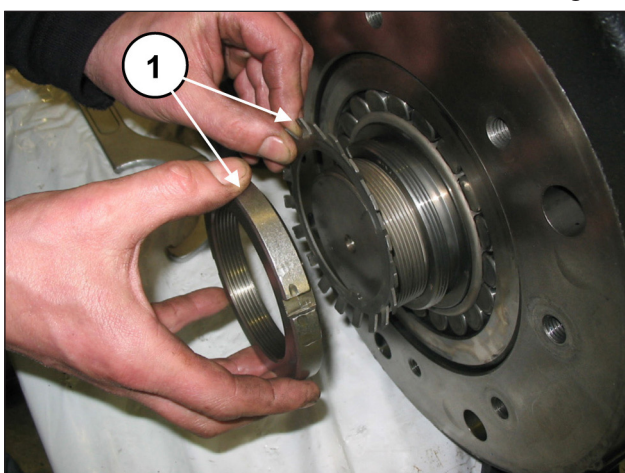

Fig. 18

Solte um anel do tipo SKF KM19 na bússola de pressão (pos. ①, Fig. 19), em seguida, usando uma chave adequada para soltar a bússola (pos. ①, Fig. 20).

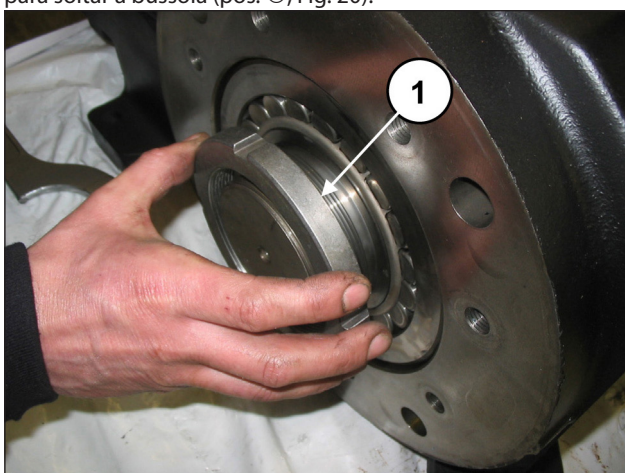

Fig. 19

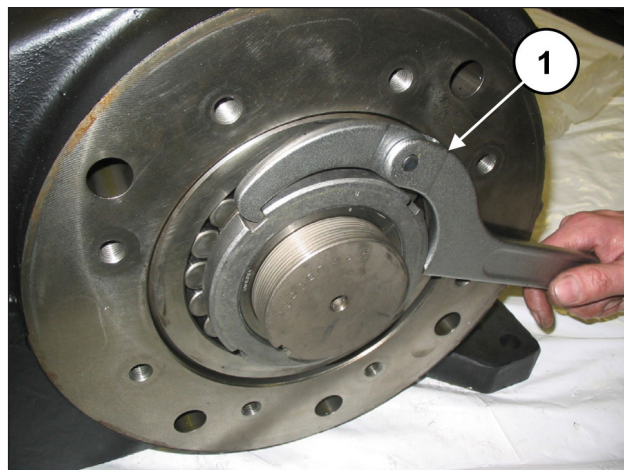

Fig. 20

Do lado oposto, solte os parafusos de fixação da caixa do redutor (pos. ①, Fig. 21), em seguida, remova-a (pos. ①, Fig. 22).

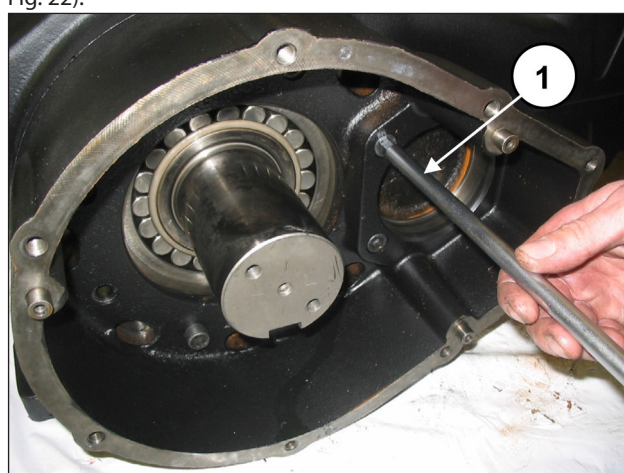

Fig. 21

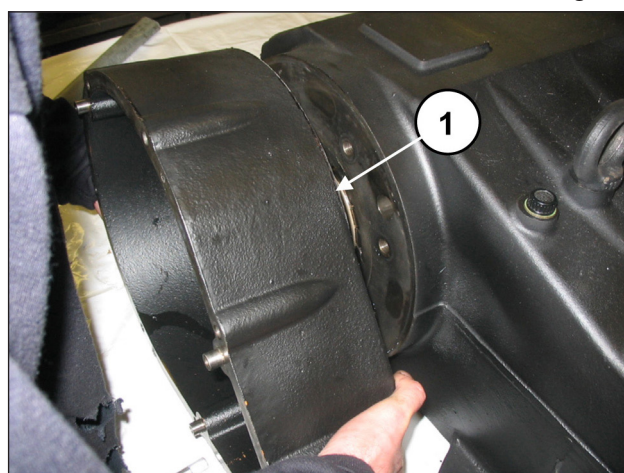

Fig. 22

Solte os parafusos da haste (pos. ①, Fig. 23).

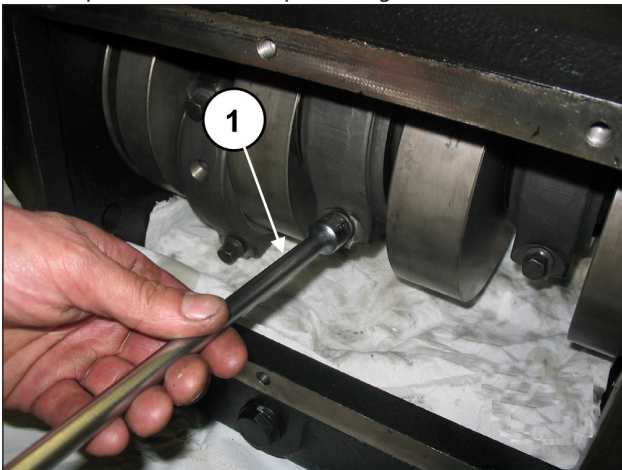

Fig. 23

Desmonte os chapéus da haste com os semi-rolamentos tendo cuidado especial durante a desmontagem, da ordem em que são desmontados.



Os chapéus da haste e as semi-hastes relativas devem ser remontados exatamente na mesma ordem e acoplamento em que foram desmontados.

Para evitar possíveis erros do chapéu e semi-hastes, foram numerados em um lado (pos. ①, Fig. 24).

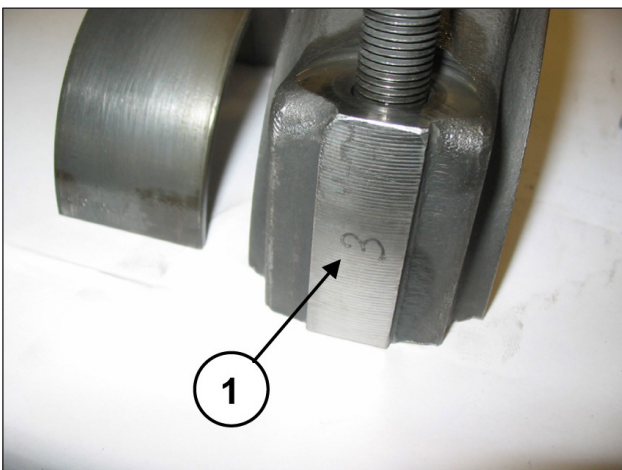

Fig. 24

Avance as semi-hastes na direção da parte hidráulica, para permitir a fuga do eixo. Para facilitar a operação, use a ferramenta adequada (cód. 27566200), (pos. ①, Fig. 25).

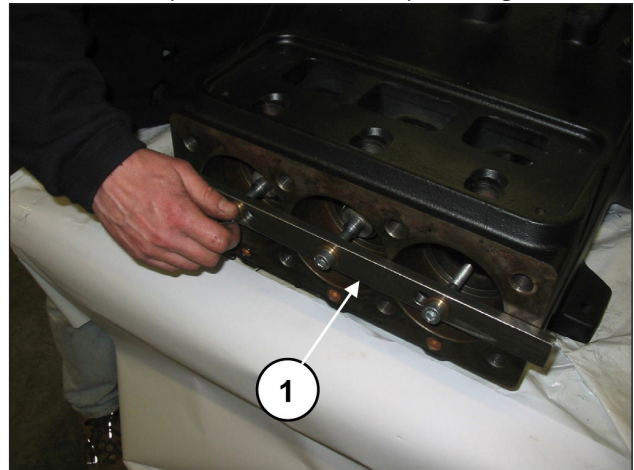

Fig. 25

Retire a bússola de pressão (pos. ①, Fig. 26).

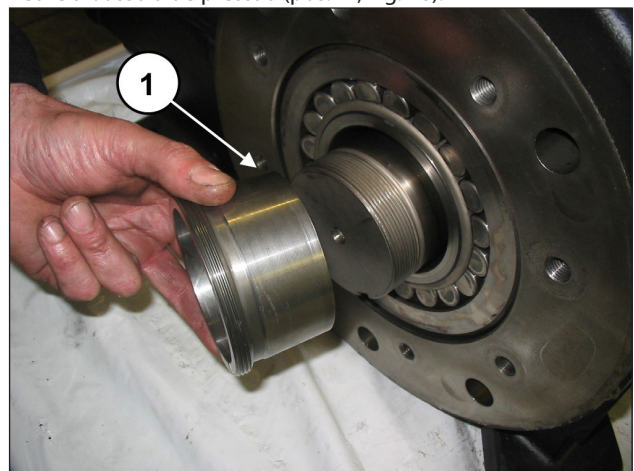

Fig. 26

Solte os três semi-rolamentos superiores das semi-hastes (pos. ①, Fig. 27).

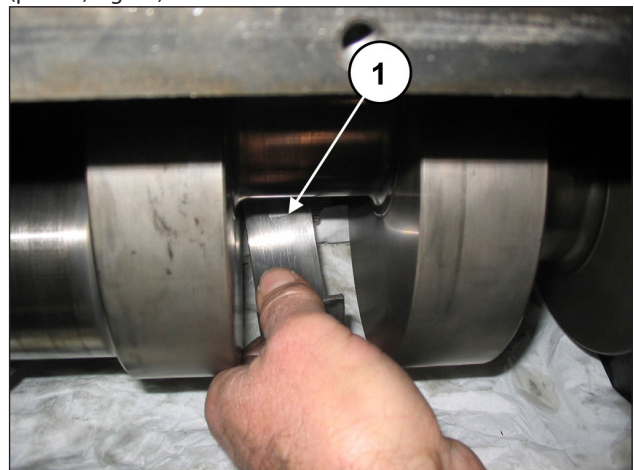

Fig. 27

Retire o eixo de manivela com o auxílio de um mecanismo de percussão do lado da PTO (pos. ①, Fig. 28).
 Extraia o eixo e o rolamento (pos. ①, Fig. 29).

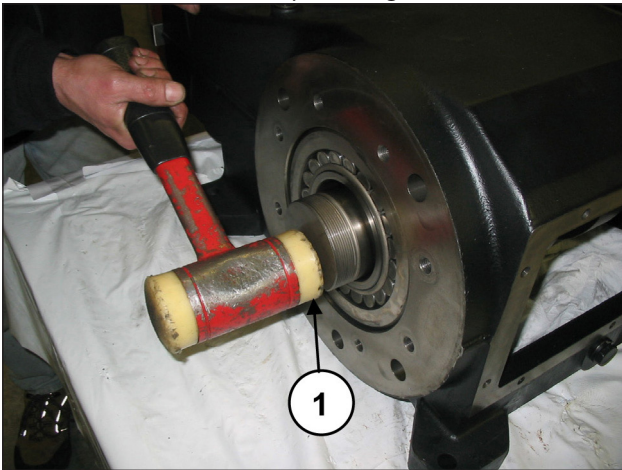

Fig. 28

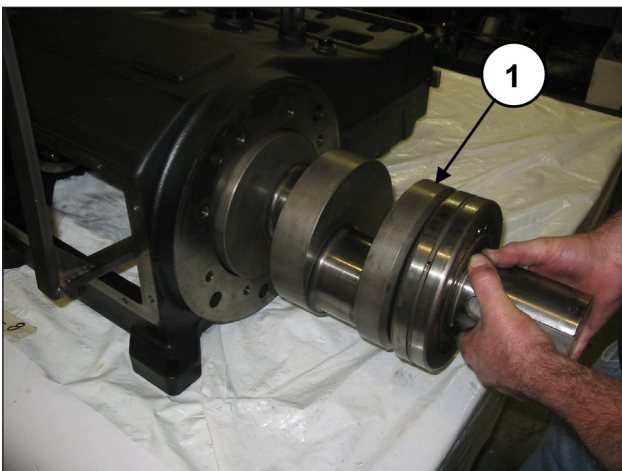

Fig. 29

Da parte oposta, extraia o rolamento (pos. ①, Fig. 30).



Fig. 30

No caso de ser necessário substituir uma ou mais hastes ou guias do pistão, é necessário operar da seguinte forma: Prossiga com o desapertar dos parafusos da ferramenta, cód. 27566200, para desbloquear as hastes (pos. ①, Fig. 31) e, em seguida, extraia os grupos da haste-guia do pistão da abertura posterior do carter (pos. ①, Fig. 32).

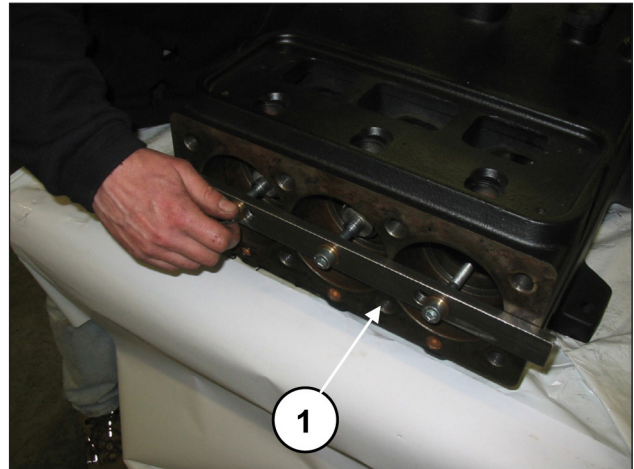

Fig. 31

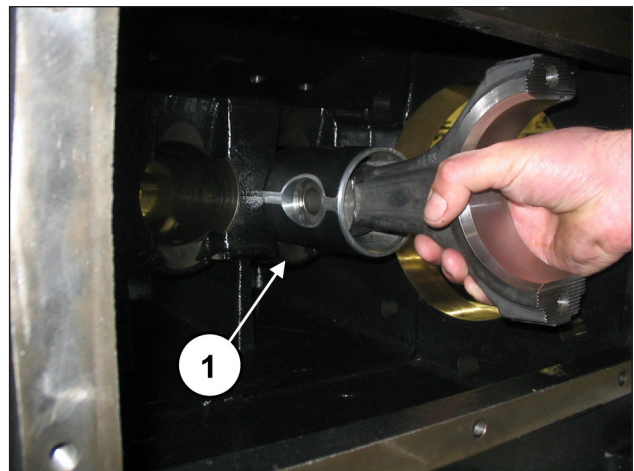

Fig. 32

Acople as semi-hastes aos chapéus anteriormente desmontados, fazendo referência à numeração (pos. ①, Fig. 33).



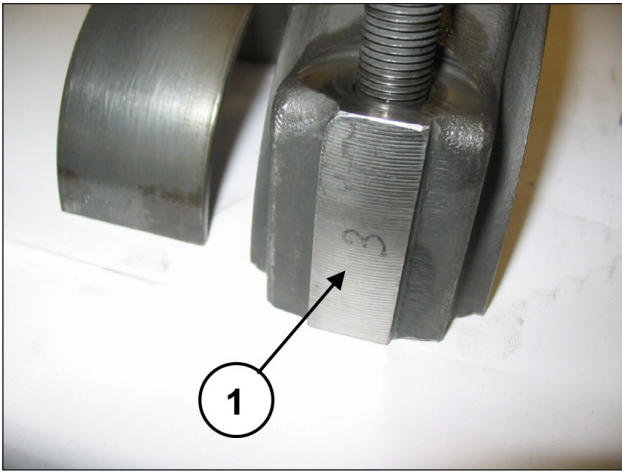

Fig. 33

Remova os dois anéis elásticos de bloqueio do pino, usando uma ferramenta adequada (pos. ①, Fig. 34).

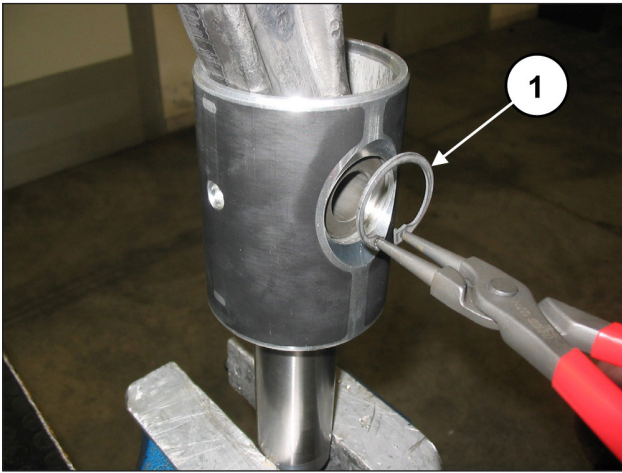

Fig. 34

Solte o pino (pos. ①, Fig. 35) e forneça a extração da haste (pos. ①, Fig. 36).



Fig. 35

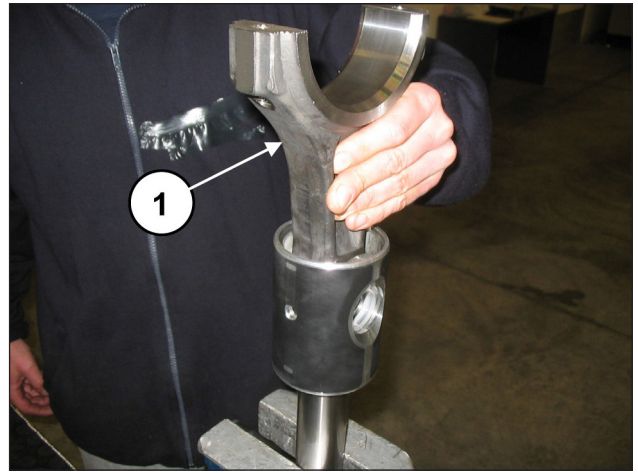

Fig. 36

Para separar a haste da guia do pistão, solte os parafusos do cabeçote cilíndrico M6, mediante a chave especial (pos. ①, Fig. 37).

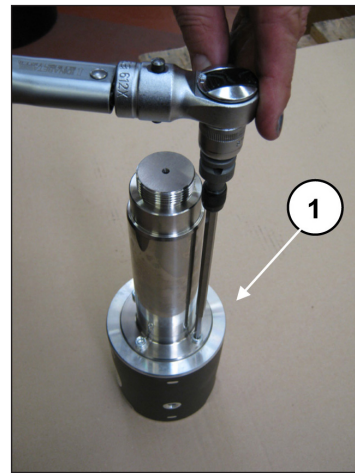

Fig. 37

2.1.2 Montagem da parte mecânica

Proceda com a montagem, seguindo o procedimento inverso ao indicado no parág. 2.1.1.

A sequência correta é a seguinte:
Monte o mesmo na guia do pistão.

Insira a mesma guia do pistão no local especial da guia do pistão (pos. ①, Fig. 38) e fixe-a a este último com os quatro parafusos do cabeçote cilíndrico M6x20 (pos. ①, Fig. 39).



Fig. 38



Fig. 39

Bloqueie a guia do pistão no gancho com ajuda de ferramenta adequada e proceda com a calibragem dos parafusos com chave dinamométrica (pos. ①, Fig. 40), conforme indicado no capítulo 3.

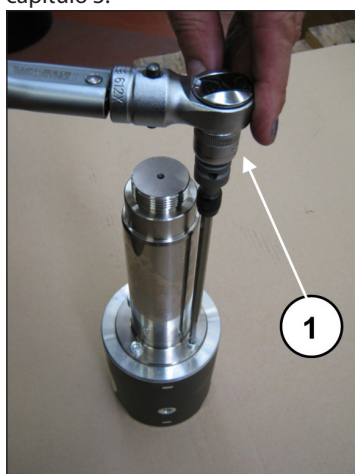

Fig. 40

Insira a haste na guia do pistão (pos. ①, Fig. 36) e, em seguida, insira o pino (pos. ①, Fig. 35). Aplique os dois anéis elásticos de desembalar com a ferramenta adequada (pos. ①, Fig. 34).



A montagem correta é garantida se o pé da haste, a guia do pistão e o pino giram livremente

Separe os chapéus das semi-hastes. O acoplamento correto será garantido pela numeração colocada em um lado (pos. ①, Fig. 33).

Depois de ter verificado a limpeza correta do carter, insira o grupo da semi-haste-guia do pistão no interior das varas do carter (pos. ①, Fig. 32).



A inserção do grupo da semi-haste-guia do pistão no carter deve ser feita orientando as semi-hastes com a numeração visível para cima.

Bloqueie os três grupos da ferramenta adequada, cód. 27566200 (pos. ①, Fig. 31).

Pré-monte o rolamento lateral da PTO no eixo até a passagem (pos. ①, Fig. 41), e monte o rolamento lateral oposto no carter (pos. ①, Fig. 42).



O rolamento na Fig. 42 tem o anel interno cônico. Verifique se a conicidade esteja na parte interna para permitir a inserção seguinte da bússola.

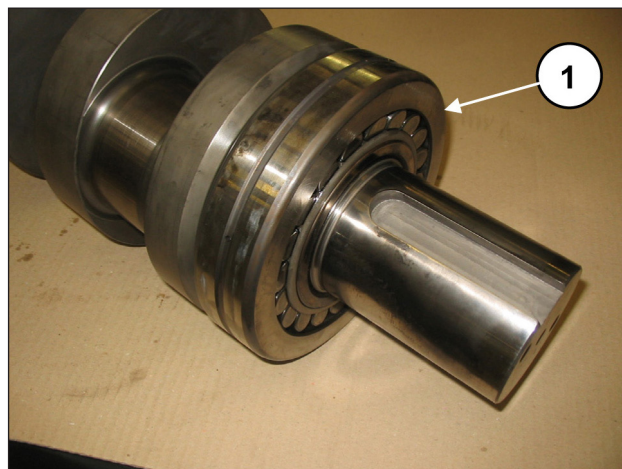

Fig. 41

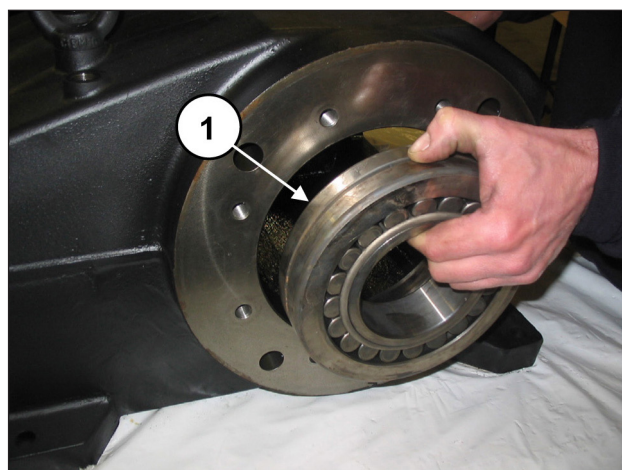

Fig. 42

Insira o eixo (pos. ①, Fig. 29), até que o rolamento pré-montado seja nivelado com a borda do carter (pos. ①, Fig. 43).

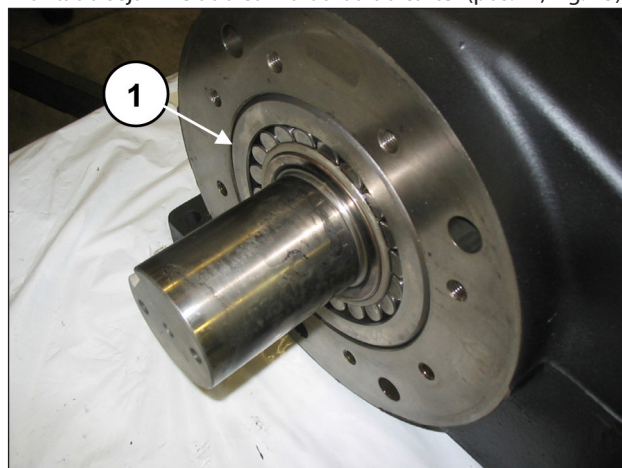

Fig. 43

Insira manualmente a bússola de pressão para manter o eixo alinhado (pos. ①, Fig. 44).

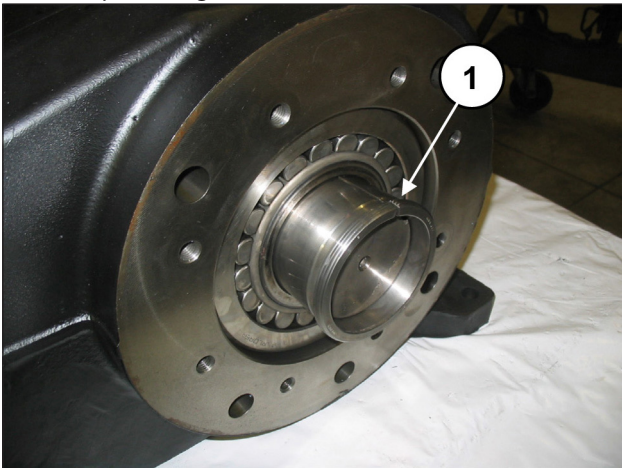

Fig. 44

Monte a caixa do redutor (pos. ①, Fig. 45) e o forro relativo (pos. ②, Fig. 45), usando os seis parafusos M12x40 (pos. ①, Fig. 46), os dois parafusos M12x50 (pos. ①, Fig. 47) e as arruelas Grower Ø12 (pos. ②, Fig. 46 e Fig. 47).
 Calibre os parafusos com chave dinamométrica (pos. ①, Fig. 48), conforme indicado no capítulo 3.

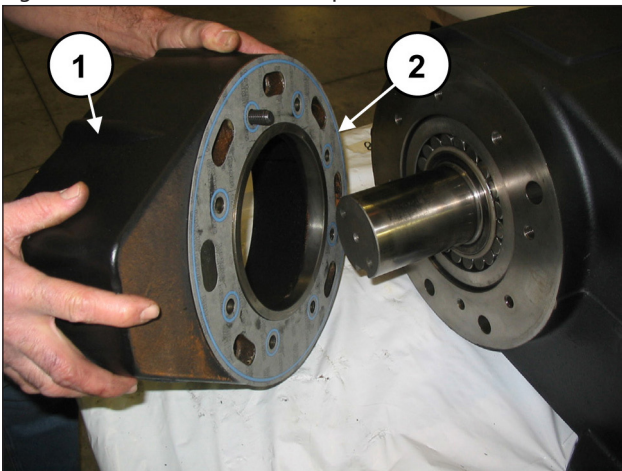

Fig. 45

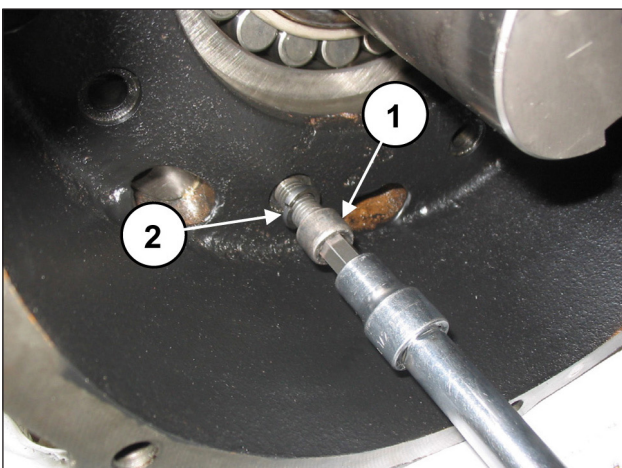

Fig. 46

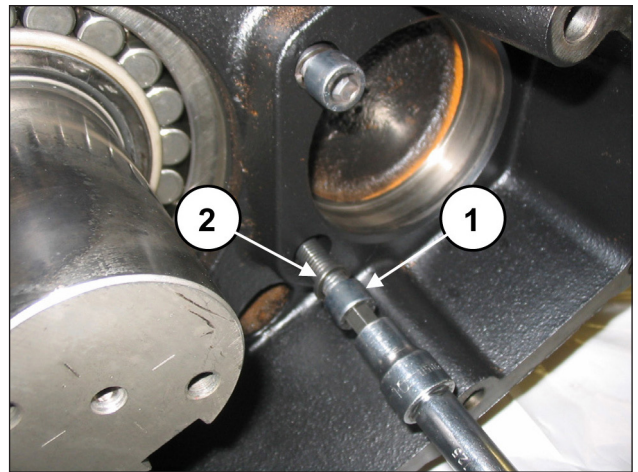

Fig. 47

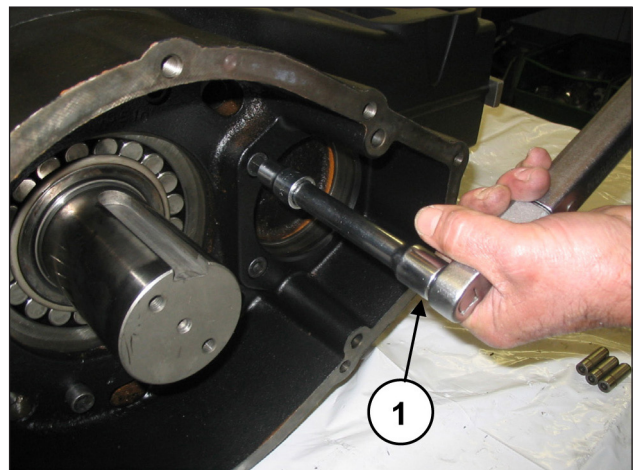

Fig. 48

Insira completamente a bússola de pressão no eixo do lado oposto à PTO (pos. ①, Fig. 49 e Fig. 50).



Fig. 49



Fig. 50



A inserção da bússola depressão deve ser realizada a seco (sem óleos ou lubrificantes).

Insira a bússola até que a superfície externa (cônica) se acople perfeitamente no interior do rolamento. Durante a inserção, certifique-se de que o rolamento permaneça em contato com o encosto do eixo.

Meça a cota "X", indicada na Fig. 51.

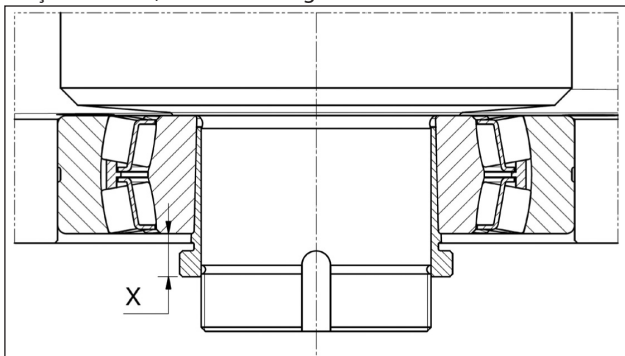

Fig. 51

Aperte o anel de bloqueio e a bússola até determinar uma redução da cota "X" entre 0.7 e 0.8 mm (Fig. 52).

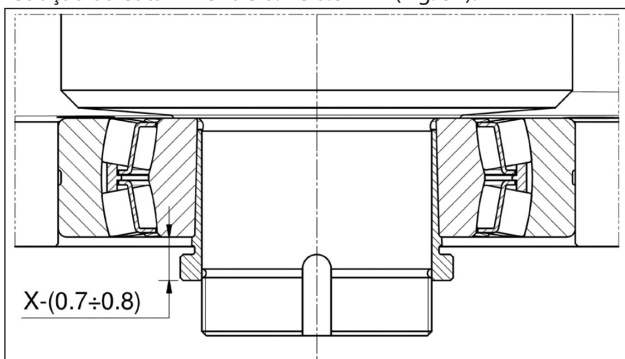

Fig. 52

Solte o anel, insira a arruela de segurança (pos. ①, Fig. 53), e reaperte completamente o anel (pos. ①, Fig. 54), em seguida, dobre a lingueta de bloqueio da arruela (pos. ①, Fig. 55).

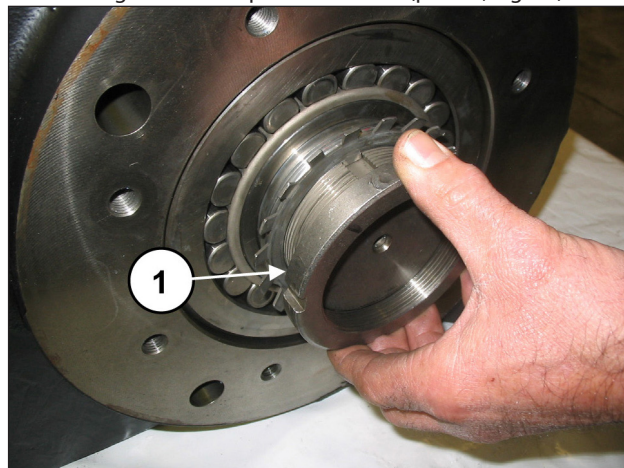

Fig. 53

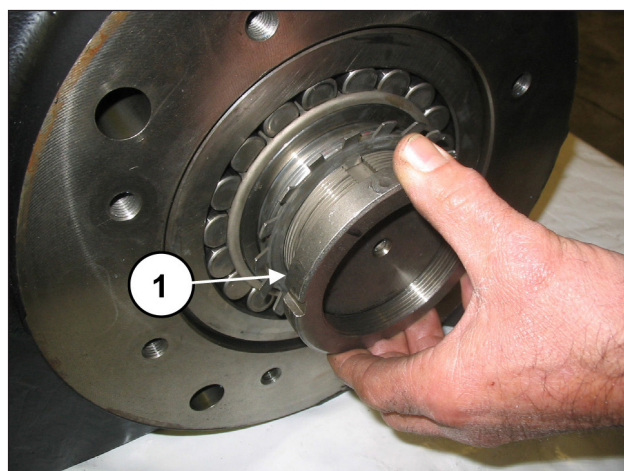

Fig. 54

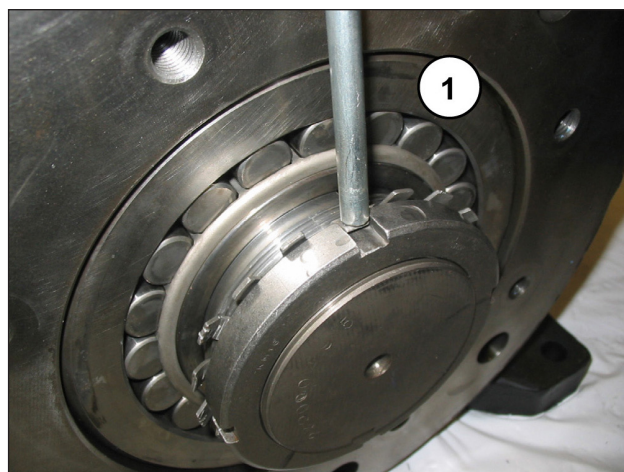

Fig. 55

Remova a ferramenta para o bloqueio da haste, cód. 27566200 (pos. ①, Fig. 31).

Insira os semi-rolamentos superiores entre a haste e o eixo (pos. ①, Fig. 56).



Para uma montagem correta dos semi-rolamentos, certifique-se de que a lingueta de referência dos semi-rolamentos esteja posicionada na caixa adequada sobre a semi-haste (pos. ①, Fig. 57).

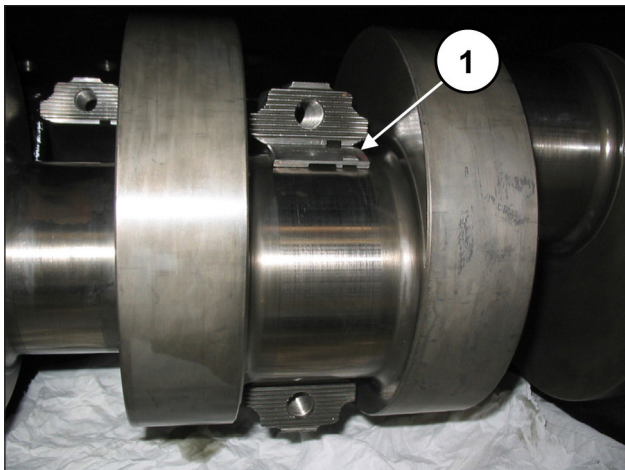

Fig. 56

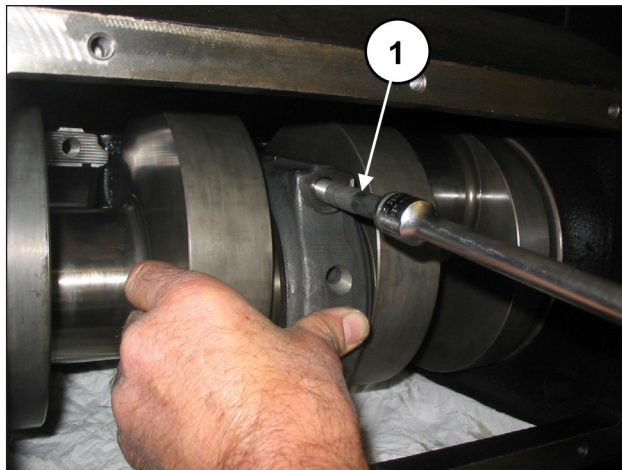

Fig. 59

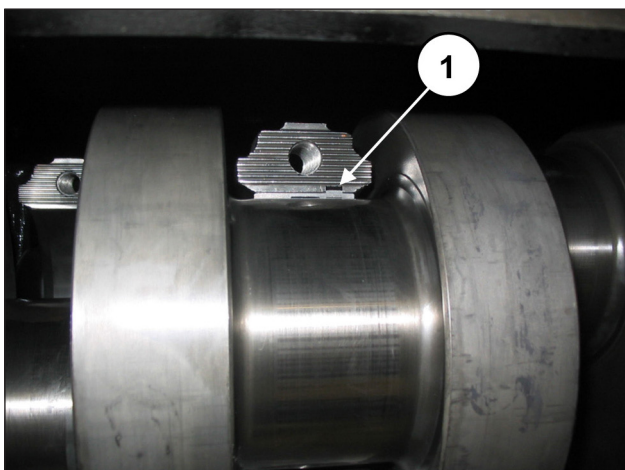

Fig. 57

Aplique os semi-rolamentos inferiores aos chapéus (pos. ①, Fig. 58), certificando-se que a lingueta de referência dos semi-rolamentos esteja posicionada na caixa sobre o chapéu (pos. ②, Fig. 58).

Fixe os chapéus nas semi-hastes mediante os parafusos M12x1.25x87 (pos. ①, Fig. 59).



Preste atenção na direção correta da montagem dos chapéus. A numeração deve ser virada para cima.

Calibre os parafusos com chave dinamométrica, conforme indicado no capítulo 3, trazendo os parafusos com o torque de aperto simultaneamente.

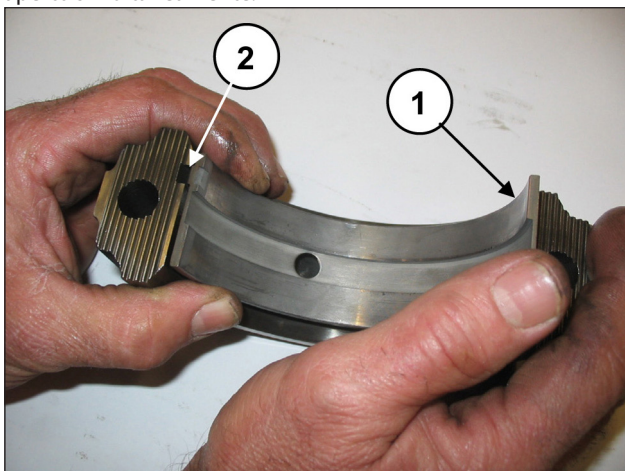

Fig. 58



Com a operação concluída, verifique se as hastes tenham uma folga axial em todas as direções.

Pré-monte o rolamento no pinhão (pos. ①, Fig. 60), e insira totalmente o pinhão no local da caixa do redutor (pos. ①, Fig. 61), mediante um mecanismo de percussão.

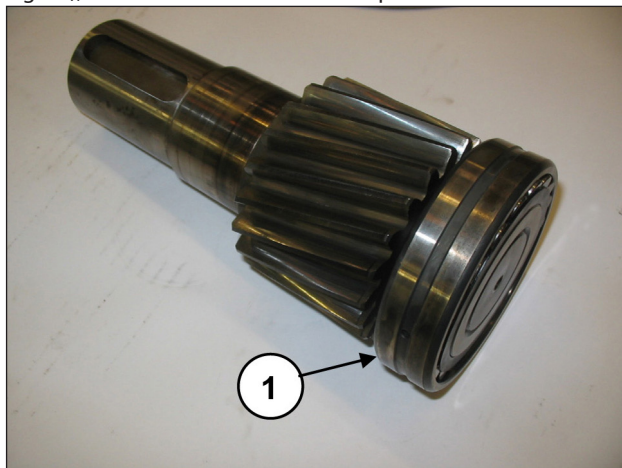

Fig. 60

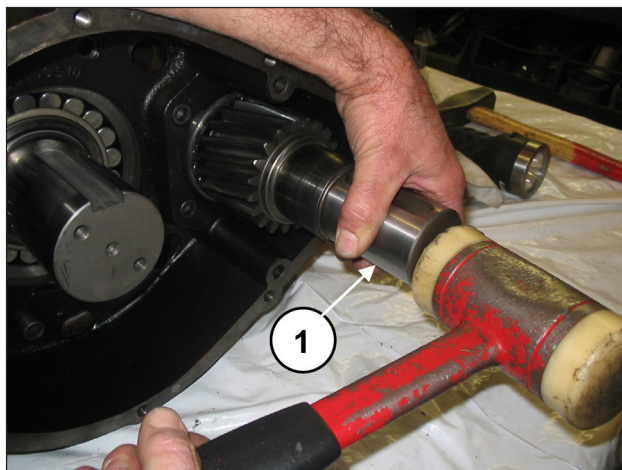

Fig. 61

Aplique a lingueta 22x14x100 no local do eixo (pos. ①, Fig. 62), e insira a coroa no eixo.

Fixe a fixação da coroa (pos. ①, Fig. 63), usando os dois parafusos M10x25 (pos. ②, Fig. 63).

Calibre os parafusos com chave dinamométrica, conforme indicado no capítulo 3.

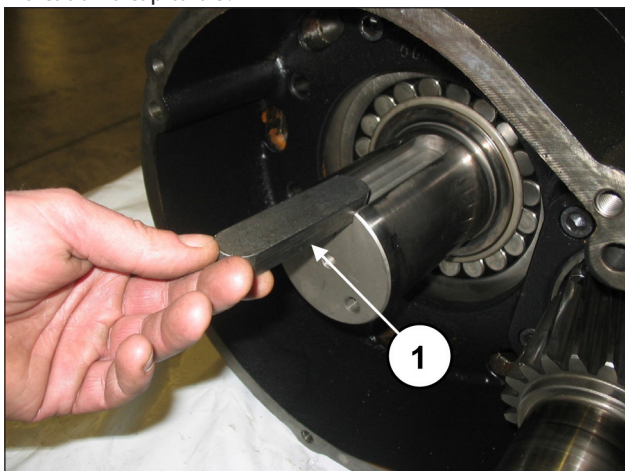

Fig. 62

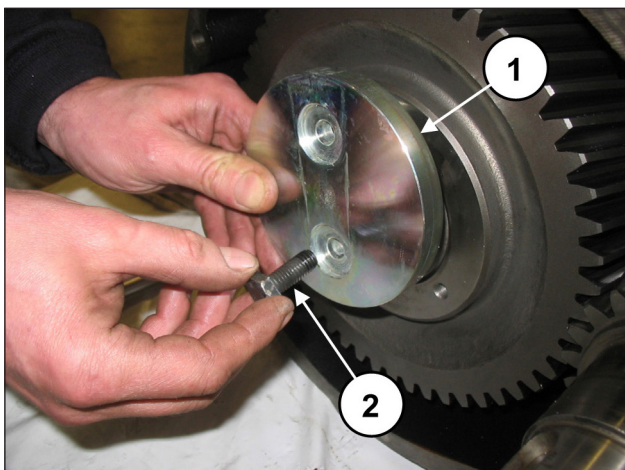

Fig. 63

Aplique os três pinos Ø12x40 na caixa do redutor (pos. ①, Fig. 64), e insira o forro (pos. ①, Fig. 65).



Fig. 64

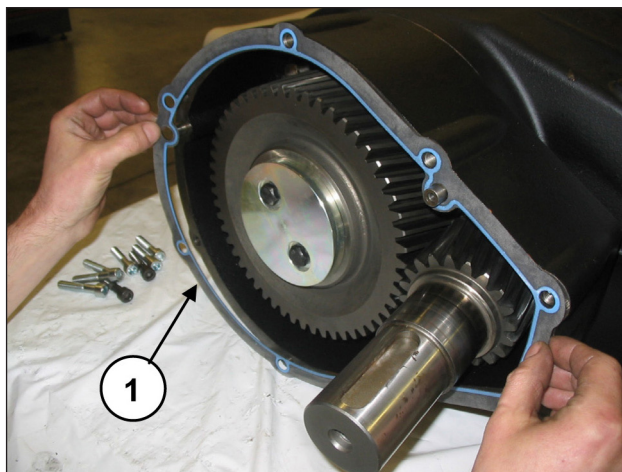

Fig. 65

Monte o rolamento na cobertura do redutor (pos. ①, Fig. 66).

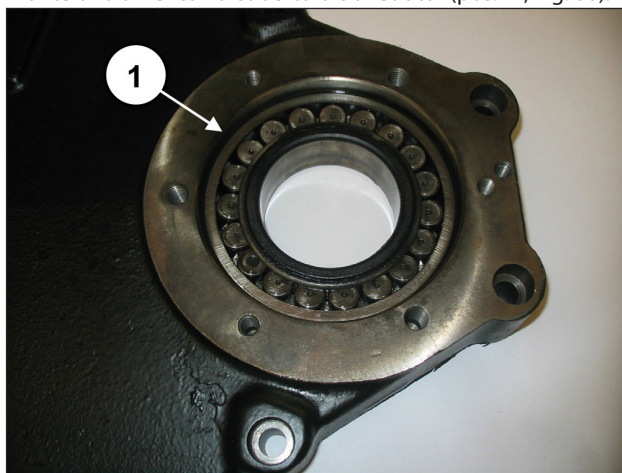

Fig. 66

Monte a cobertura do redutor (pos. ①, Fig. 67), e fixe-o com oito parafusos M10x50 (pos. ①, Fig. 68). Use um tampão para evitar que o rolamento possa sair do seu local (pos. ①, Fig. 69). Calibre os parafusos com chave dinamométrica, conforme indicado no capítulo 3.

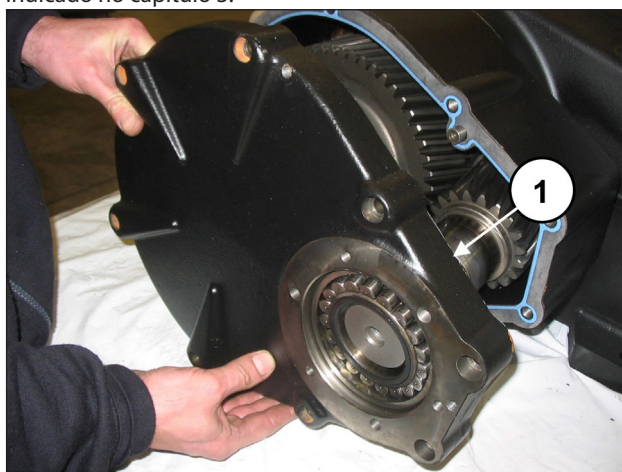

Fig. 67

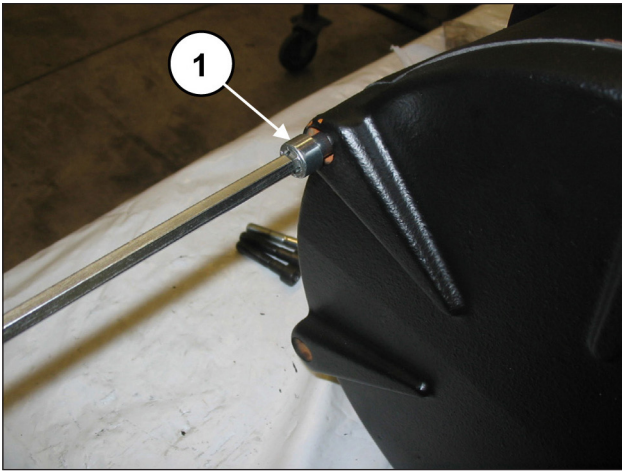

Fig. 68



Fig. 69

Insira a vedação do óleo no interior da flange do redutor, mediante o uso das ferramentas, cód. 27515900 e 27548200 (pos. ①, Fig. 70).

Antes de realizar a montagem das vedações do óleo, verifique as condições das bordas de vedação. Se a substituição for necessária, posicione o novo anel no fundo do buraco, conforme indicado na Fig. 71.



Se o eixo apresentar um desgaste do diâmetro correspondente à borda da vedação para evitar a operação de retificação, pode-se posicionar o anel na segunda passagem, conforme indicado na Fig. 71.

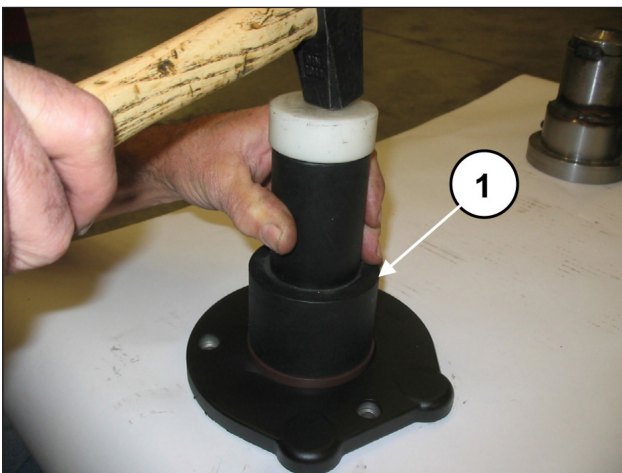

Fig. 70

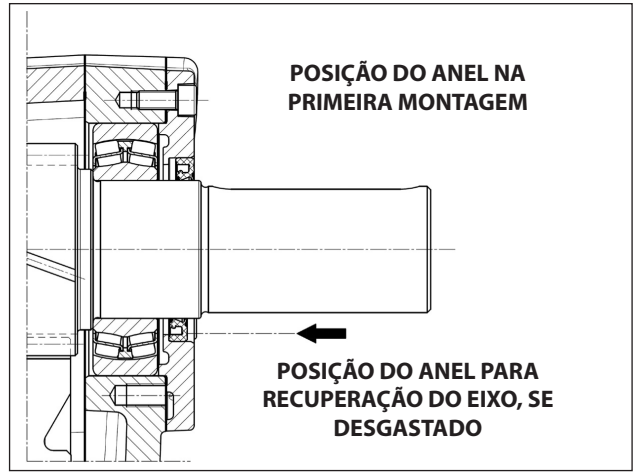

Fig. 71

Aplique a flange do redutor, com o relativo forro na caixa do redutor (pos. ①, Fig. 72), e solte-a, mediante três parafusos M8x18 (pos. ①, Fig. 73).



Para evitar danos à vedação do óleo, preste atenção particular na inserção da flange no pinhão

Calibre os parafusos com chave dinamométrica, conforme indicado no capítulo 3.

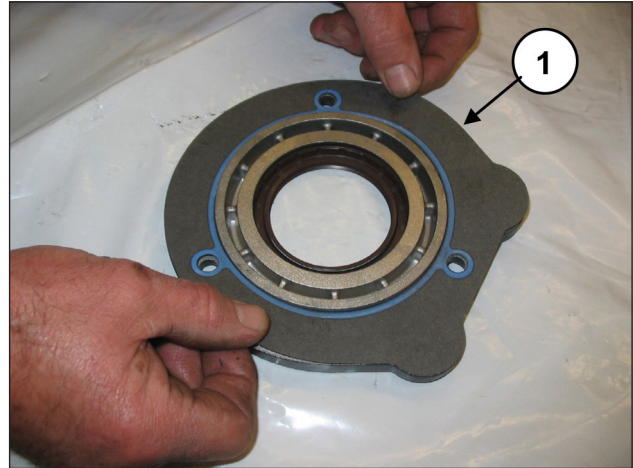

Fig. 72

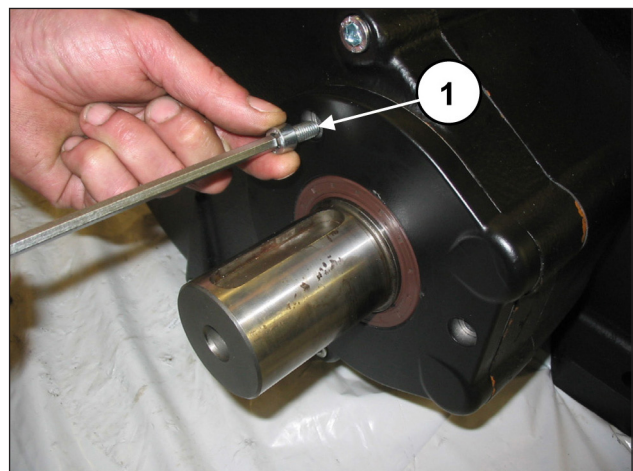

Fig. 73

Insira a lingueta 16x10x90 no pinhão.

Insira o anel circular na cobertura posterior (pos. ①, Fig. 74), e fixe-o ao carter, mediante dez parafusos M8x18 (pos. ①, Fig. 75).
 Calibre os parafusos com chave dinamométrica, conforme indicado no capítulo 3.

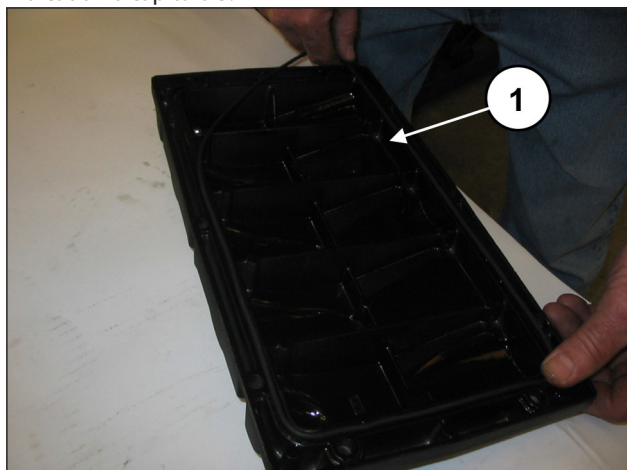

Fig. 74

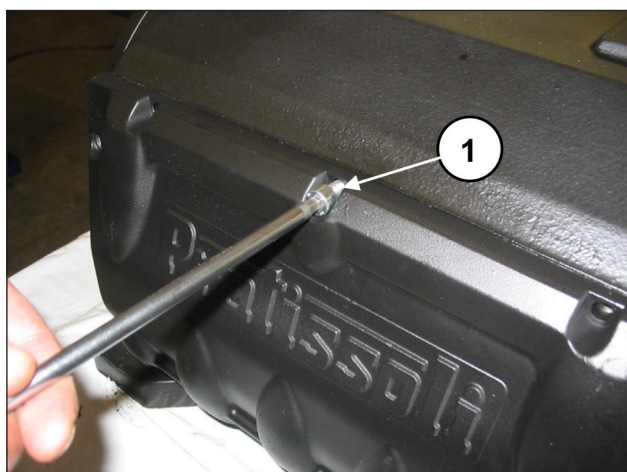

Fig. 75

Monte a cobertura do rolamento (e relativo forro) (pos. ①, Fig. 76), mediante os oito parafusos M12x30 (pos. ①, Fig. 77).

2.1.3 Classes de aumento previstas

TABELA DE AUMENTO PARA O EIXO DE MANIVELA E SEMI-ROLAMENTOS DA HASTE			
Classe de recuperação (mm)	Código do semi-rolamento superior	Código do semi-rolamento inferior	Correção do diâmetro do pino do eixo (mm)
0.25	90931100	90930100	Ø92.75 0/-0.03 Ra 0.4 Rt 3.5
0.50	90931200	90930200	Ø92.50 0/-0.03 Ra 0.4 Rt 3.5

TABELA DE AUMENTO PARA O CARTER DA BOMBA E GUIA DO PISTÃO		
Classe de recuperação (mm)	Código da guia do pistão	Correção do local do carter da bomba (mm)
1.00	79050543	Ø81 H6 +0.022/0 Ra 0.8 Rt 6

Calibre os parafusos com chave dinamométrica, conforme indicado no capítulo 3.

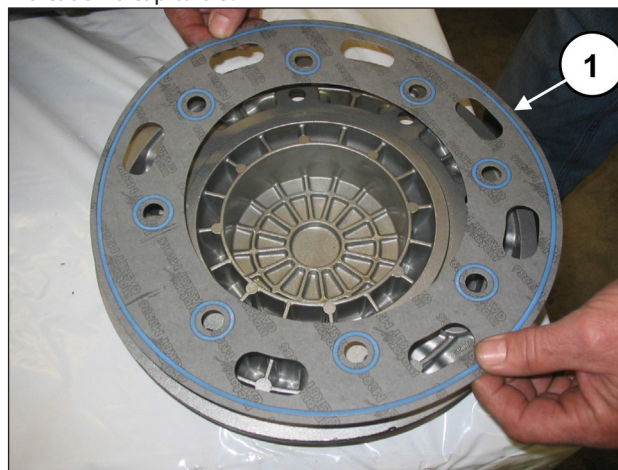

Fig. 76



Fig. 77

Complete a montagem da parte mecânica, aplicando as tampas e os olhais de elevação com o anel circular de vedação relativo.

Insira o óleo no carter, conforme indicado no **Manual de uso e manutenção**, parág. 7.4.

2.2 REPARAÇÃO DA PARTE HIDRÁULICA

2.2.1 Desmontagem do cabeçote - grupos da válvula

O cabeçote precisa de uma manutenção preventiva, conforme indicado no *Manual de uso e manutenção*.

As intervenções são limitadas à inspeção ou substituição da válvula, quando necessário.

Para a extração dos grupos da válvula, opere como mostra a seguir:

Solte os oito parafusos M16x55 da cobertura da válvula (pos. ①, Fig. 78), e remova a cobertura (pos. ①, Fig. 79).

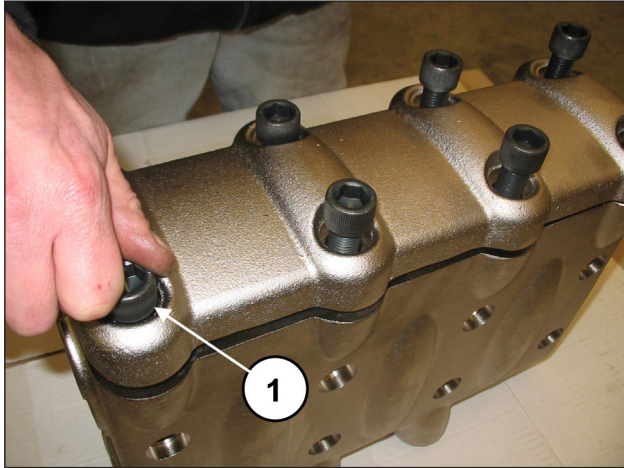

Fig. 78

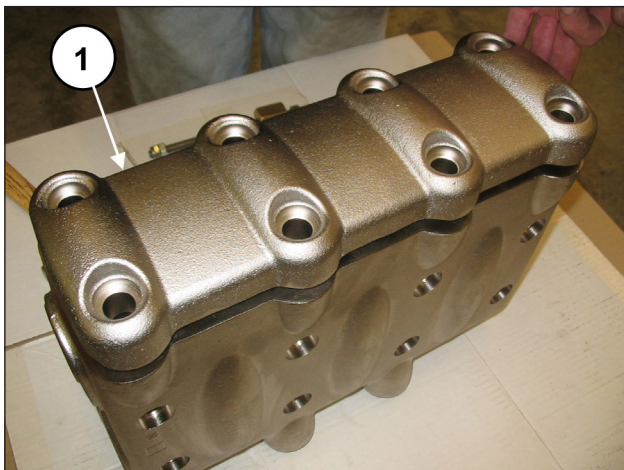

Fig. 79

Extraia a tampa da válvula com o uso de um extrator de mecanismo de percussão para aplicar o furo M10 da tampa da válvula (pos. ①, Fig. 80).

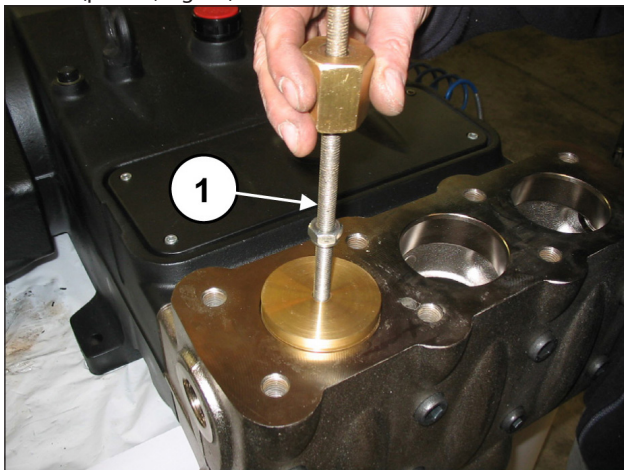

Fig. 80

Solte a mola (pos. ①, Fig. 81).

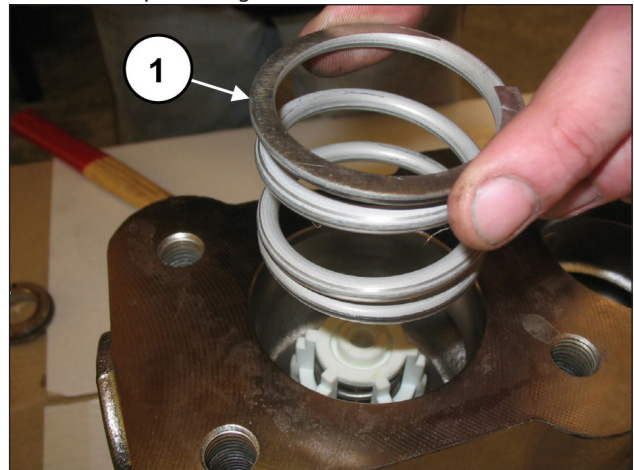

Fig. 81

Extraia o grupo da válvula de fluxo, mediante o uso de um extrator de mecanismo de percussão, para aplicar no furo M10 da guia da válvula (pos. ①, Fig. 82).

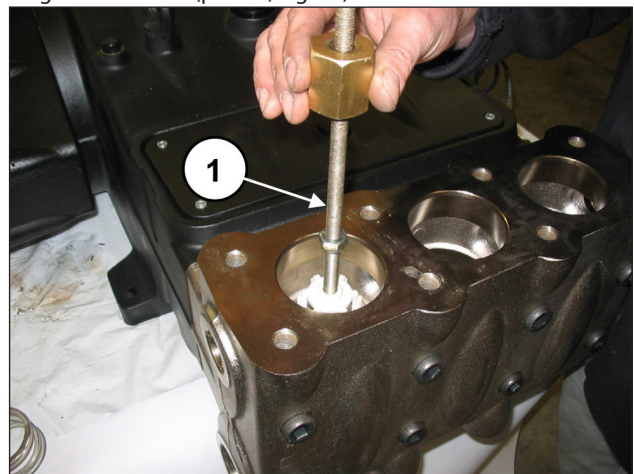

Fig. 82



Se a extração do grupo da válvula de fluxo permanecer particularmente difícil (por ex., para incrustações devido a uma inutilização prolongada da bomba), use a ferramenta do extrator, cód. 27516400.

Extraia o espaçador da guia da válvula, mediante o uso de uma chave hexagonal de 8 mm (pos. ①, Fig. 83).

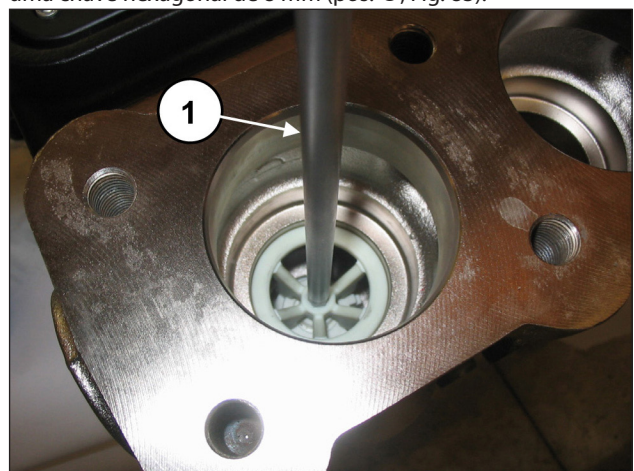

Fig. 83

Extraia o grupo da válvula de aspiração, mediante o uso de um extrator de mecanismo de percussão, para aplicar no furo M10 da guia da válvula (pos. ①, Fig. 84).

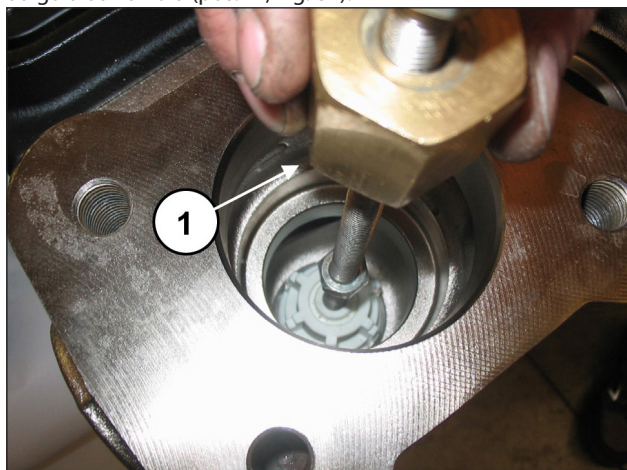

Fig. 84



Se a extração do grupo da válvula de aspiração permanecer particularmente difícil (por ex., para incrustações devido a uma inutilização prolongada da bomba), use a ferramenta do extrator cód. 27516200 (nas versões com Ø pistão: 40 - 45 - 50) ou o cód. 27516300 (nas versões com Ø pistão: 55 - 60 - 65).

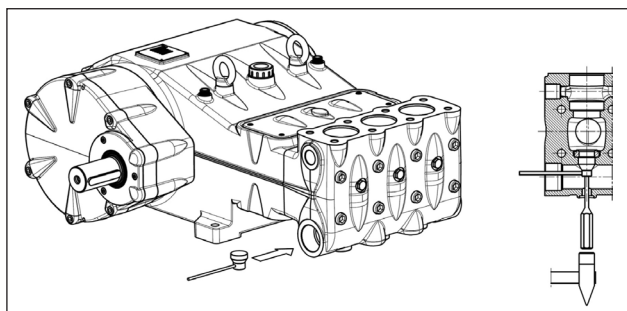

Fig. 85

Solte o dispositivo de abertura da válvula mediante chave de 30 mm (cód. ①, Fig. 86).

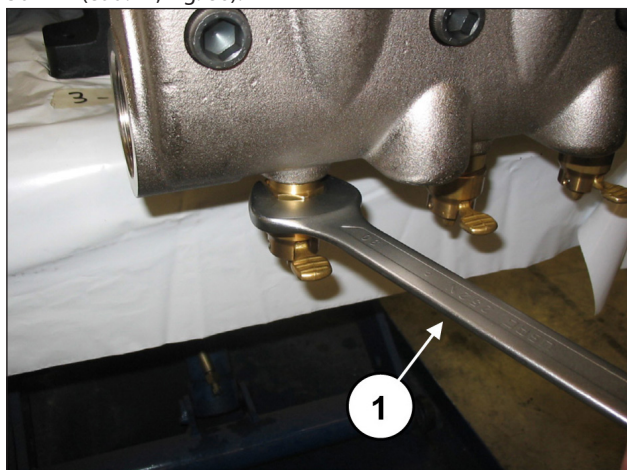

Fig. 86

Desmonte os grupos da válvula de aspiração e de fluxo, soltando um parafuso M10 de modo a pressionar na guia interna e extrair a guia da válvula do local da válvula (pos. ①, Fig. 87).

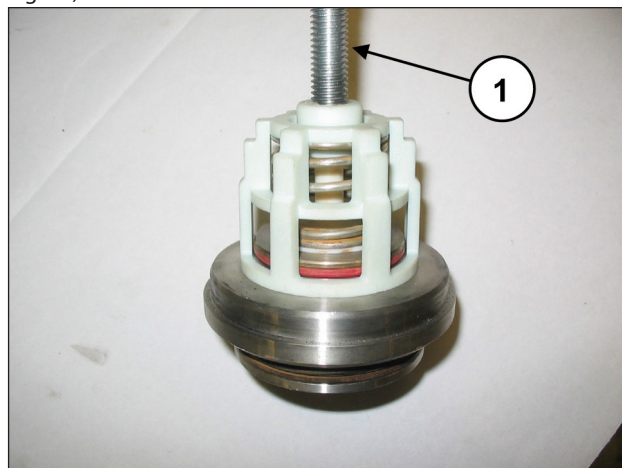

Fig. 87

2.2.2 Montagem do cabeçote - grupos da válvula



Preste atenção especial ao estado de desgaste dos vários componentes e substitua-os, quando necessário.

A cada inspeção da válvula, substitua todos os anéis circulares, seja dos grupos ou das tampas da válvula.



Antes de reposicionar os grupos da válvula, limpe e enxugue perfeitamente as relativas ranhuras no cabeçote, indicadas pela seta (pos. ①, Fig. 88).

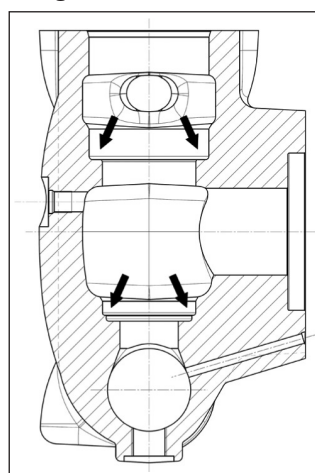

Fig. 88

Proceda com a remontagem, seguindo o procedimento inverso da remontagem indicada no parág. 2.2.1.

Monte os grupos da válvula de aspiração e de fluxo (Fig. 89 e Fig. 90), prestando atenção para não inverter as molas anteriormente desmontadas.

Para facilitar a inserção da guia da válvula no local, pode-se usar um tubo que apoie as placas horizontais da guia (Fig. 91) e usar um mecanismo de percussão, agindo em toda a circunferência



Fig. 89

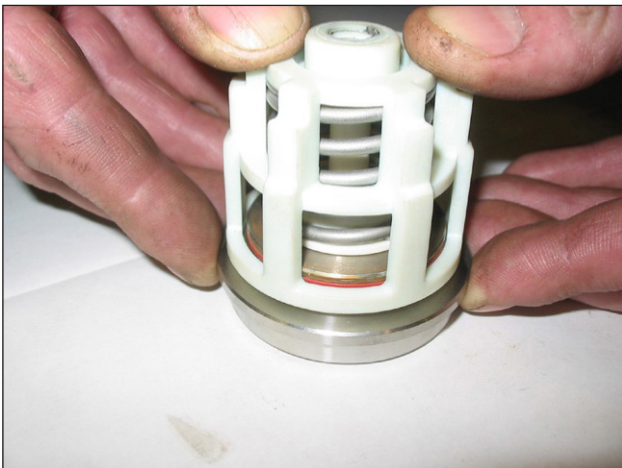

Fig. 90

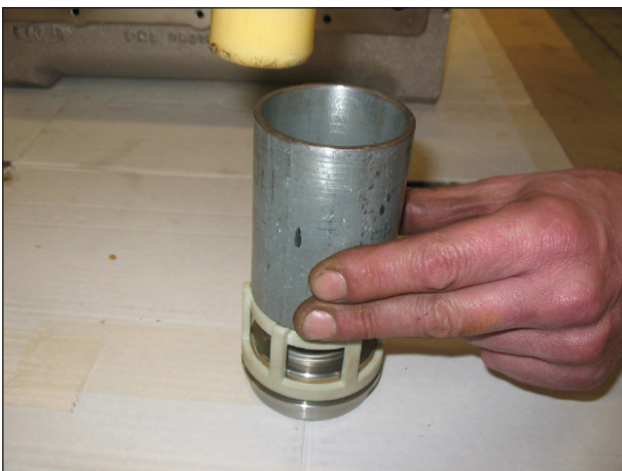

Fig. 91



Proceda com a inserção dos grupos da válvula (aspiração e de fluxo) no cabeçote, prestando atenção à sequência correta da inserção dos anéis circulares e dos anéis de anti-extrusão.

A sequência correta de montagem dos grupos da válvula no cabeçote é a seguinte:

Insira o anel anti-extrusão, pos. de explosão nº. 4 (pos. ①, Fig. 92).

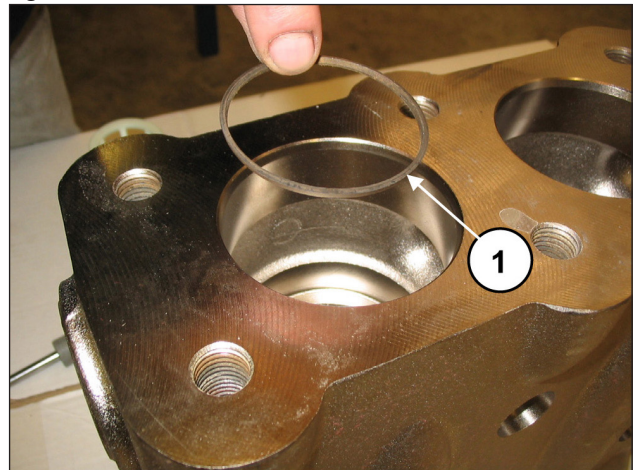

Fig. 92

Insira o anelo circular, pos. de explosão nº. 5 (pos. ①, Fig. 93).

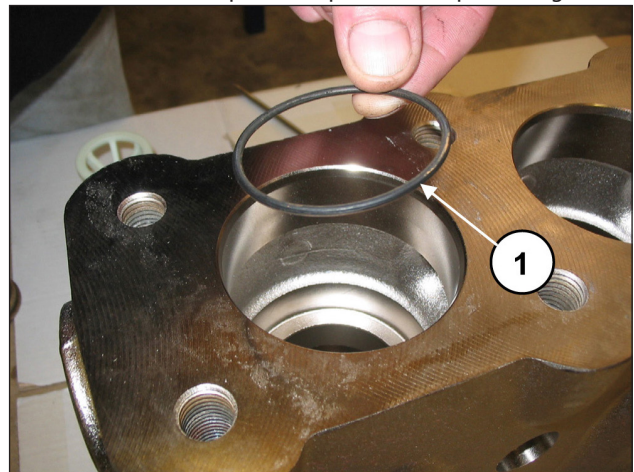

Fig. 93

Verifique se o anel circular e o anel de anti-extrusão ficaram perfeitamente no local.

Insira o grupo da válvula de aspiração (pos. ①, Fig. 94) e sucessivamente o espaçador (pos. ①, Fig. 95).

O grupo da válvula completo deve ser inserido completamente no fundo e apresentar-se como na pos. ①, Fig. 95.

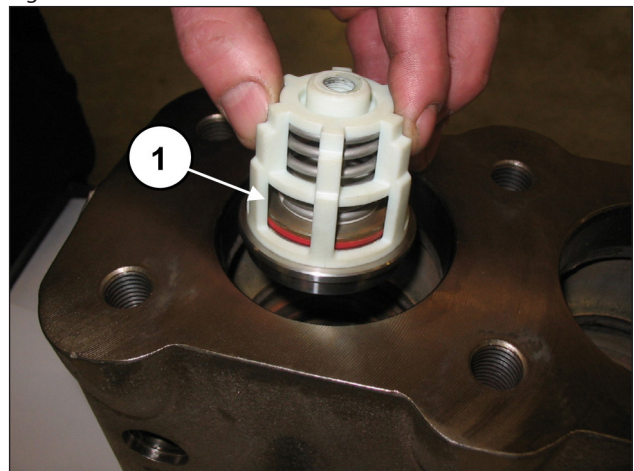

Fig. 94

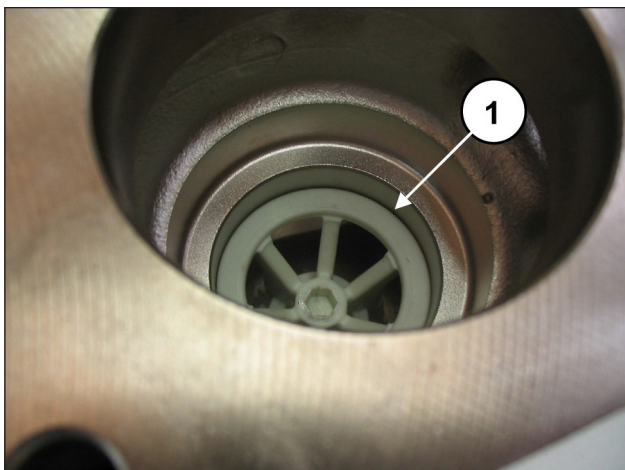

Fig. 95

Monte o anel circular, pos. de explosão nº. 5 (pos. ①, Fig. 96) e o anel anti-extrusão, pos. de explosão nº. 15 (pos. ②, Fig. 96) sobre o local da válvula de fluxo.

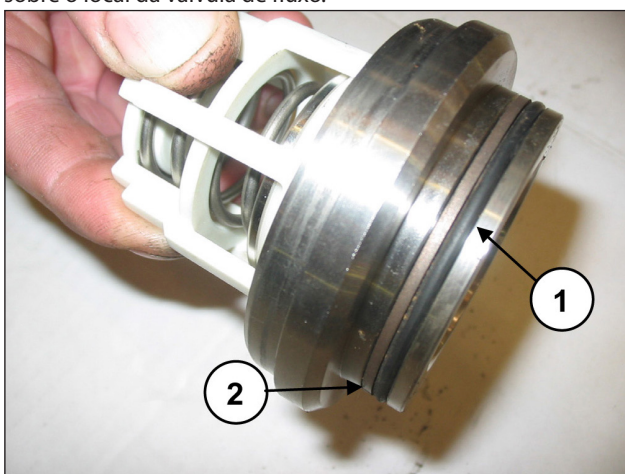

Fig. 96

Insira o grupo da válvula de fluxo (pos. ①, Fig. 97). O grupo da válvula deve ser inserido completamente no fundo e apresentar-se como na pos. ①, Fig. 98.

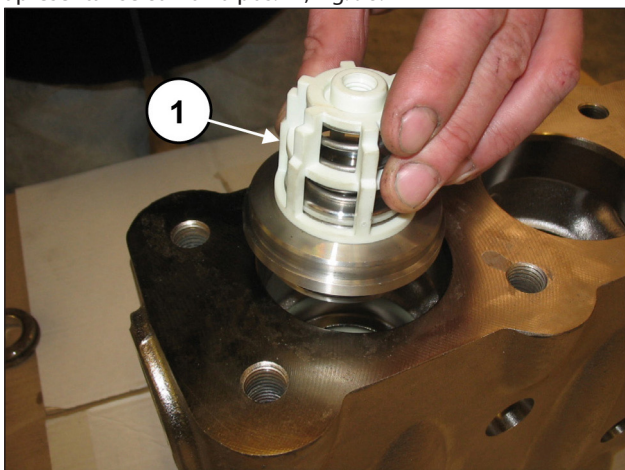

Fig. 97

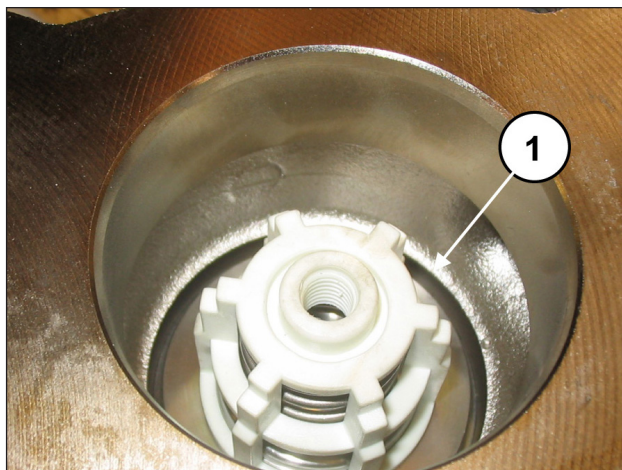

Fig. 98

Insira o anel anti-extrusão, pos. de explosão nº. 16 (pos. ①, Fig. 99).

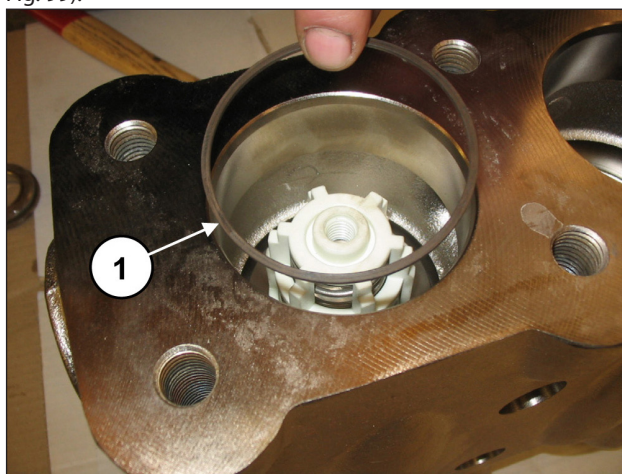

Fig. 99

Insira o anelo circular, pos. de explosão nº. 17 (pos. ①, Fig. 100).

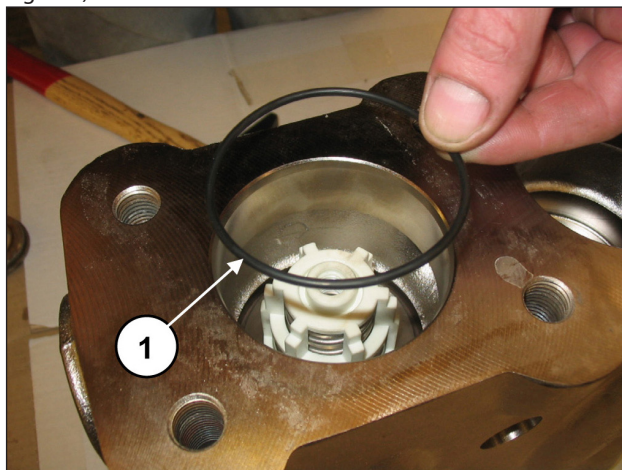

Fig. 100



Preste atenção especial na inserção do anel circular indicado na pos. ①, Fig. 101. Aconselha-se o uso da ferramenta cod. 27516000 (nas versões com Ø pistão: 40 - 45 - 50) ou o cód. 27516100 (nas versões com Ø pistão: 55 - 60 - 65) para evitar que o anel circular possa partir durante a inserção.

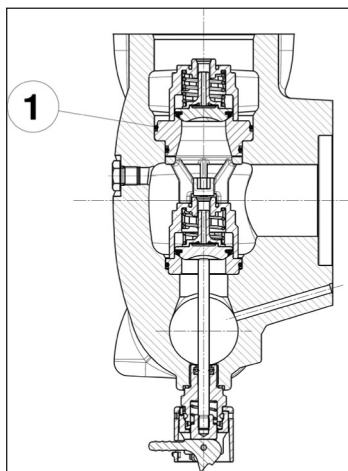

Fig. 101

Insira o anel do local da válvula (pos. ①, Fig. 102) e a mola (pos. ①, Fig. 103).

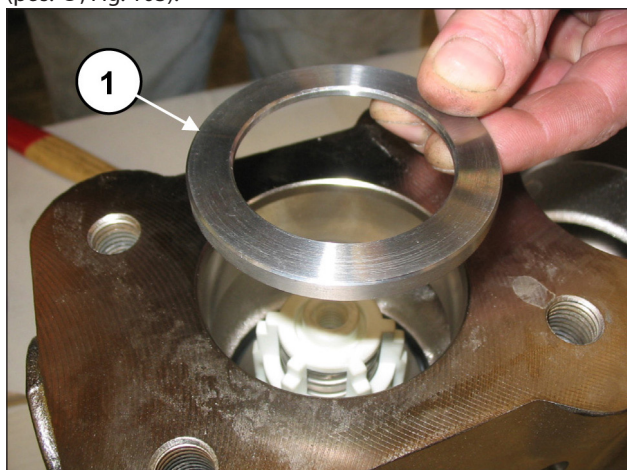

Fig. 102

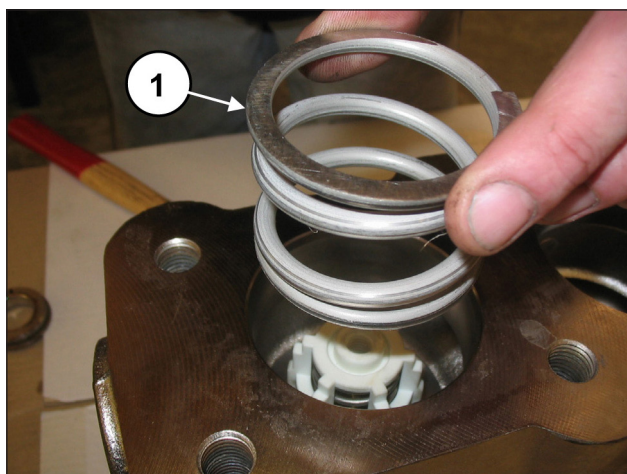

Fig. 103

Monte o anel circular, pos. de explosão nº. 17 (pos. ①, Fig. 104) e o anel anti-extrusão, pos. de explosão nº. 21 (pos. ②, Fig. 104) na tampa da válvula de fluxo.

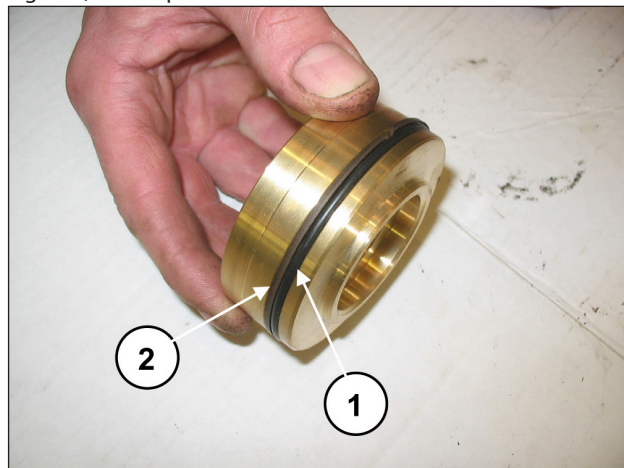

Fig. 104

Insira a tampa da válvula completa com o anel circular e anéis anti-extrusão.

Depois de ter terminado com a montagem dos grupos da válvula e da tampa da válvula, aplique a cobertura da válvula (pos. ①, Fig. 105) e solte os oito parafusos M16x55 (pos. ①, Fig. 106).

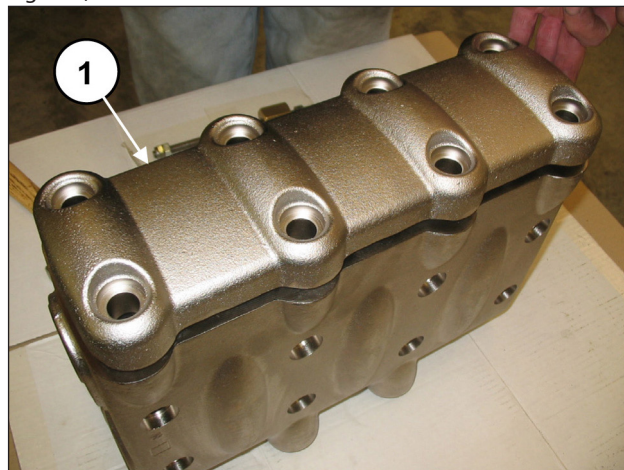

Fig. 105

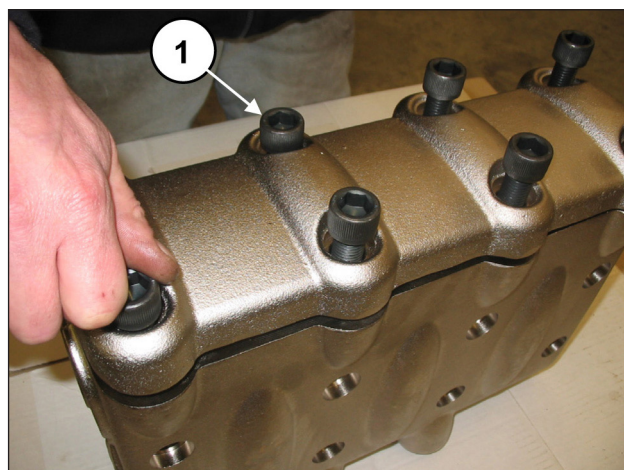

Fig. 106

Monte o cabeçote no carter da bomba (pos. ①, Fig. 107), prestando atenção para não bater nos pistões e solte os oito parafusos M16x180 (pos. ①, Fig. 108).

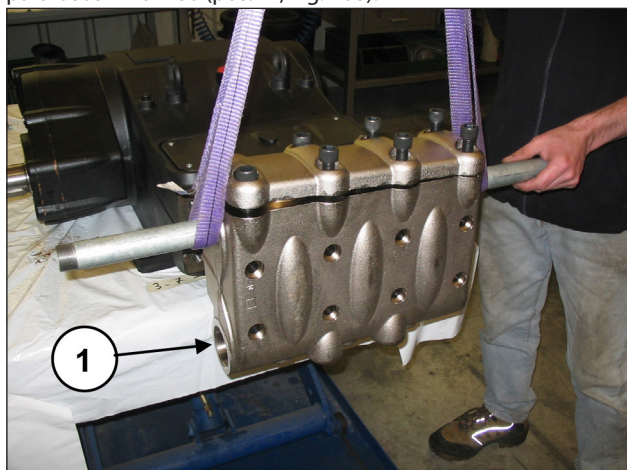

Fig. 107

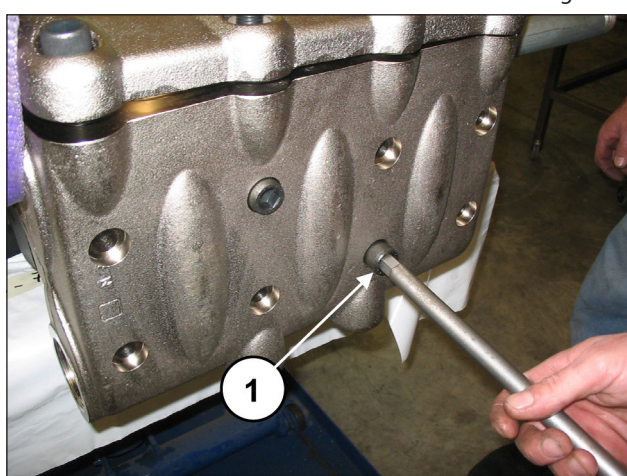

Fig. 108

Proceda com a calibragem dos parafusos M16x180 com chave dinamométrica, conforme indicado no capítulo 3.



Aperte os oito parafusos M16x180, começando pelos quatro parafusos internos, de modo transversal (ver Fig. 107), para depois prosseguir com os quatro parafusos externos, sempre apertando de modo transversal

Calibre os parafusos M16x55 da cobertura com chave dinamométrica, conforme indicado no capítulo 3. Aplique os dispositivos de abertura da válvula (pos. ①, Fig. 109) e solte-os mediante a chave de 30 mm (pos. ①, Fig. 110).

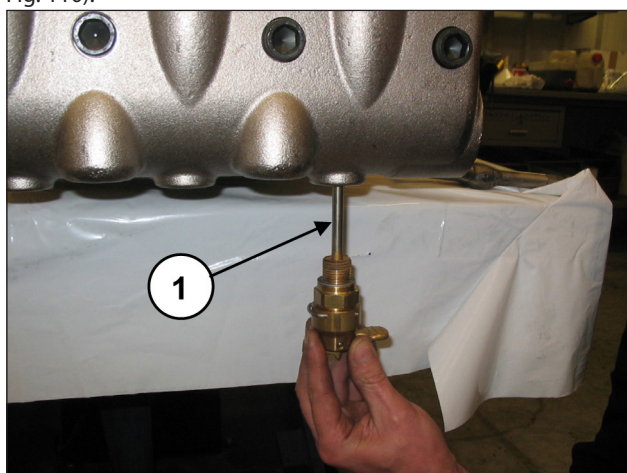

Fig. 109

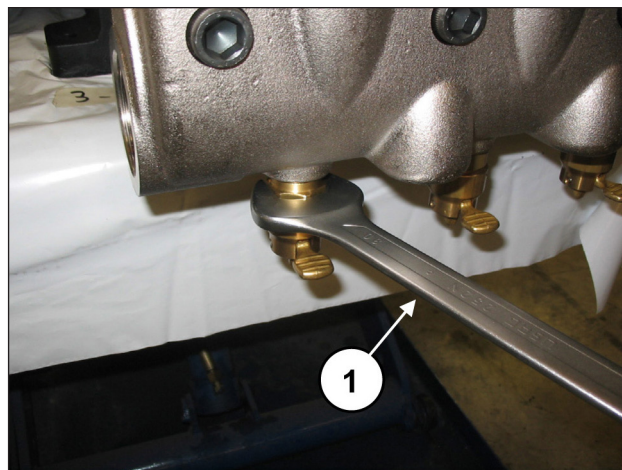

Fig. 110

2.2.3 Desmontagem do grupo do pistão - suportes - vedação

O grupo do pistão precisa de uma verificação periódica conforme indicado na tabela de manutenção preventiva do *Manual de uso e manutenção*.

As intervenções são limitadas somente ao controle visual da eventual drenagem do furo, presente na cobertura inferior. Caso se apresente anomalias/oscilações no manômetro de fluxo ou de gotejamento do furo de drenagem, será necessário proceder com o controle e a eventual substituição do pacote de vedação.

Para a extração dos grupos de pistão, opere como a seguir: Para acessar o grupo do pistão, desaperte os parafusos M16x180 e desmonte o cabeçote.



Retire o cabeçote com a máxima atenção, para evitar bater os pistões

Providencie a desmontagem dos pistões, soltando os parafusos de fixação (pos. ①, Fig. 111).

Retire o pistão do suporte de vedação e verifique se a superfície do mesmo não apresenta arranhões, sinais de desgaste ou de cavitação.

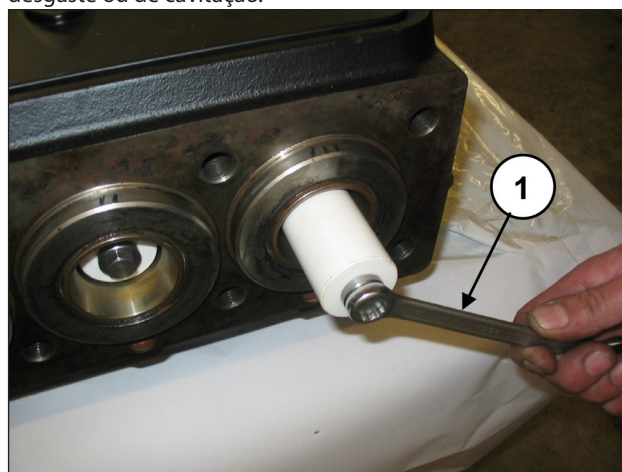

Fig. 111

Remova a cobertura de inspeção superior, soltando os quatro parafusos de fixação (pos. ①, Fig. 112).

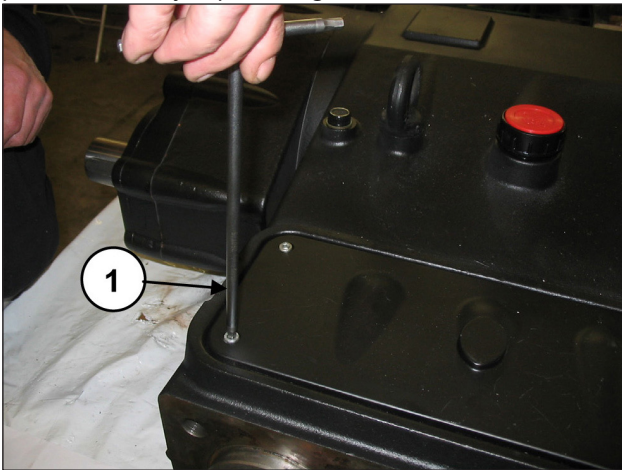

Fig. 112

Gire manualmente o eixo, de modo a trazer os três pistões na posição de ponto morto superior. Insira a ferramenta do tampão cód. 27516600 entre a guia do pistão e o pistão (pos. ①, Fig. 113).

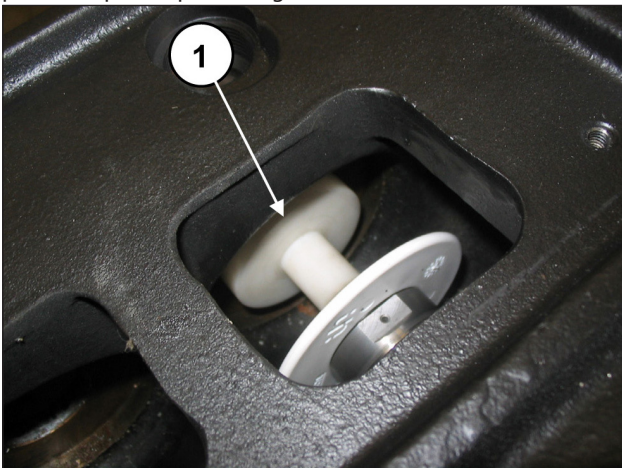

Fig. 113

Girando o eixo, avance a guia do pistão, de modo que a tampa, avançando em sua volta, podendo expelir o suporte do forro e todo o grupo do pistão (pos. ①, Fig. 114).

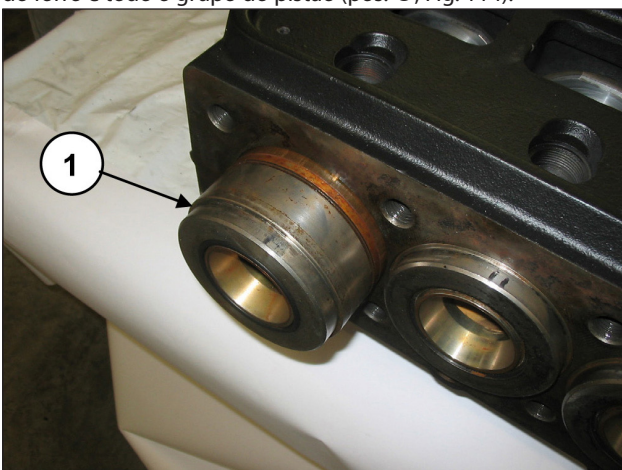

Fig. 114

Extraia o grupo de suporte das vedações e a ferramenta do tampão.

Remova o anel circular de fundo do suporte do forro, se não permanecer no interior do carter da bomba (pos. ①, Fig. 115).

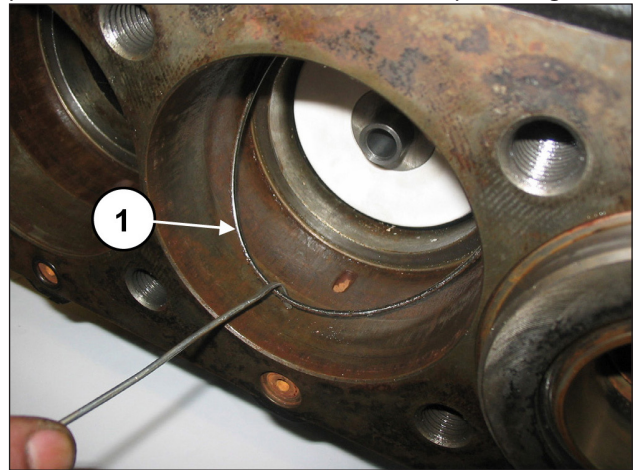

Fig. 115

Solte os anéis de proteção contra respingos da guia dos pistões (pos. ①, Fig. 116).

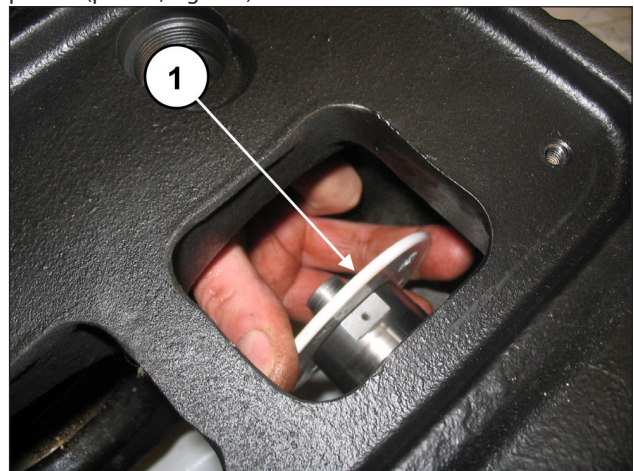

Fig. 116

Caso seja necessário substituir a vedação do óleo da guia do pistão, desmonte a cobertura da vedação do óleo, procedendo da seguinte forma:

Solte os dois parafusos de bloqueio da cobertura da vedação do óleo (pos. ①, Fig. 117).

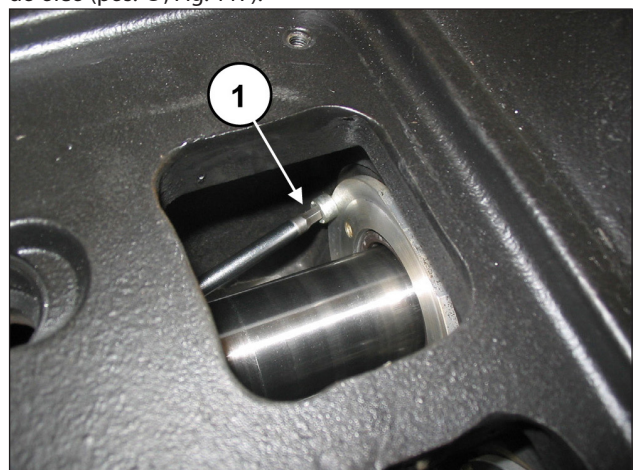

Fig. 117

Posicione a guia do pistão no ponto morto inferior, solte o extrator, cód. 27516400, incluindo o adaptador M5, cód. 27516500 nos furos adequados, colocados na cobertura (pos. ①, Fig. 118) e extraia a cobertura da vedação do óleo do grupo da bomba (pos. ①, Fig. 119).

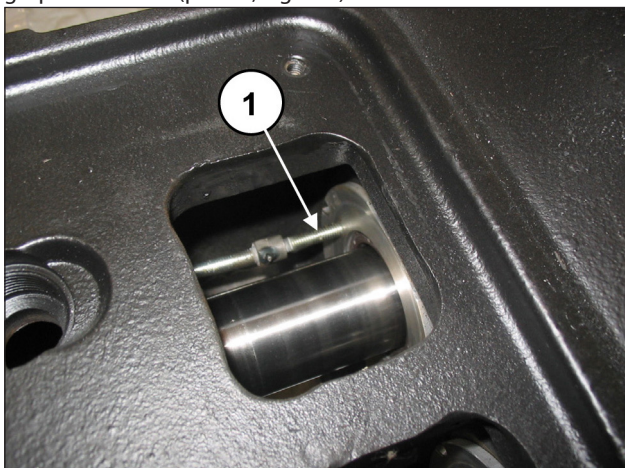

Fig. 118



Fig. 119

Substitua a vedação do óleo (pos. ①, Fig. 120) e o anel circular externo (pos. ②, Fig. 120).

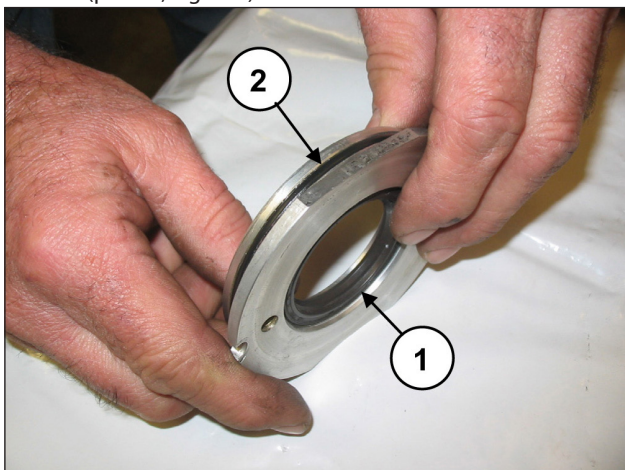

Fig. 120

Separe o suporte das vedações da camisa (pos. ①, Fig. 121), para acessar as vedações de pressão (pos. ①, Fig. 122).

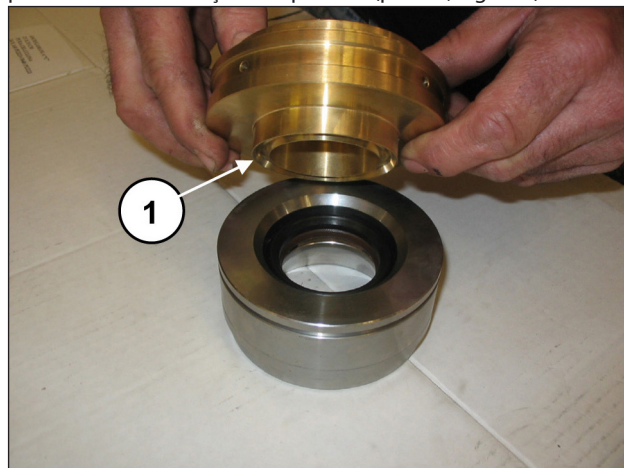

Fig. 121



Fig. 122

Para remover o forro de baixa pressão, é necessário usar um medidor de espessura ou uma ferramenta que não danifique o local do suporte do forro (pos. ①, Fig. 123).

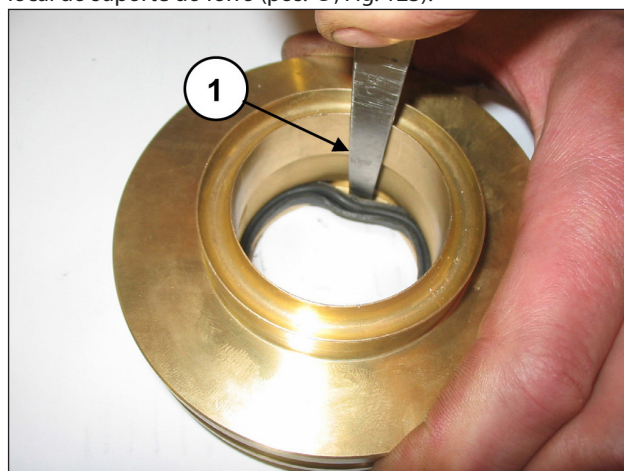

Fig. 123

2.2.4 Montagem do grupo do pistão - suportes - vedação

Proceda com a remontagem, seguindo o procedimento inverso da remontagem indicada no parág. 2.2.3.



Substitua as vedações de pressão, umedecendo as bordas com lubrificante de silicone (sem borrifar), prestando muita atenção para não danificá-las durante a inserção na camisa.



A cada desmontagem, os forros de pressão devem ser sempre substituídas juntas com todos os anéis circulares.

Insira os forros de baixa pressão no suporte do forro (pos. ①, Fig. 124) prestando atenção para o sentido da montagem, que fornece a borda de vedação para a frente (na direção do cabeçote).

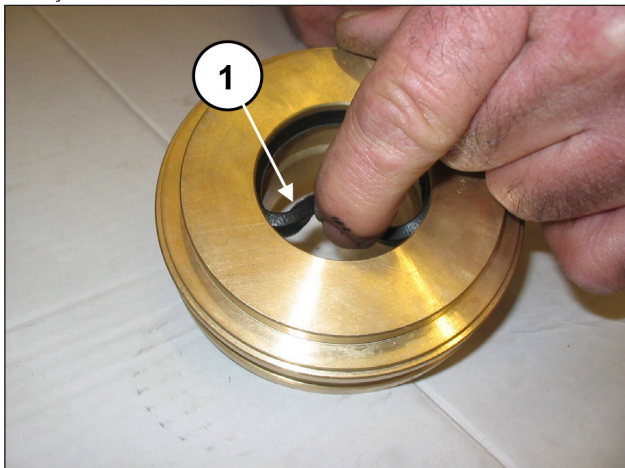

Fig. 124

Monte o anel do cabeçote (pos. ①, Fig. 125), o forro de alta pressão (pos. ①, Fig. 126) e o anel restop (pos. ①, Fig. 127).



Fig. 125

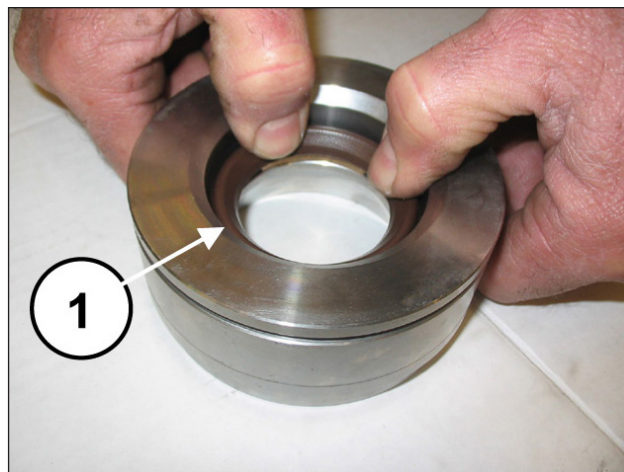

Fig. 126



Fig. 127

Junte o suporte do forro à camisa (pos. ①, Fig. 128).

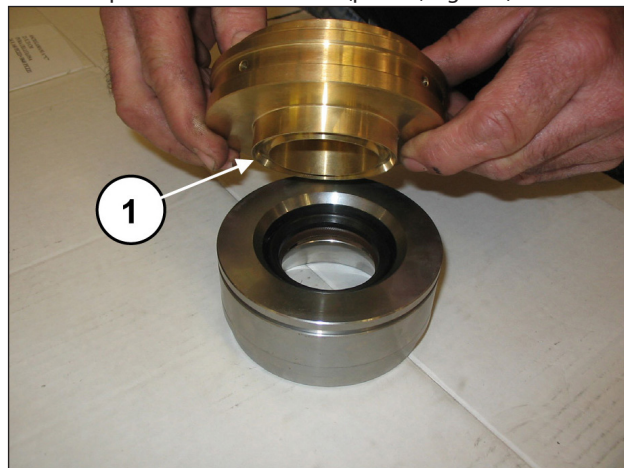

Fig. 128

Monte a vedação do óleo na cobertura da mesma (pos. ①, Fig. 129), mediante o uso de uma tampa, cód. 27910900.

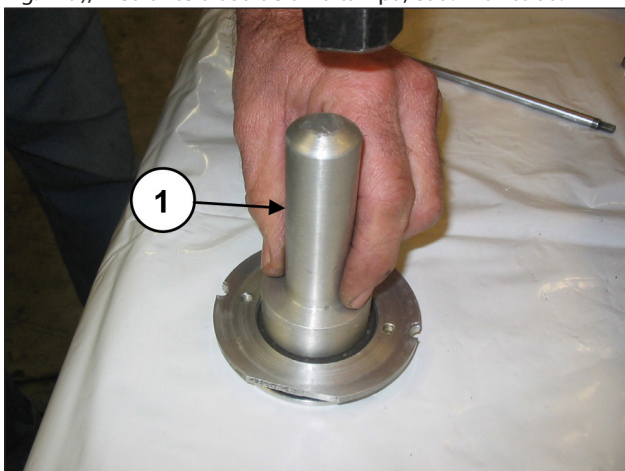

Fig. 129

Posicione o anel circular (pos. ①, Fig. 130) no local da cobertura da vedação do óleo e insira o grupo montado no interior do carter no local adequado (pos. ①, Fig. 131).

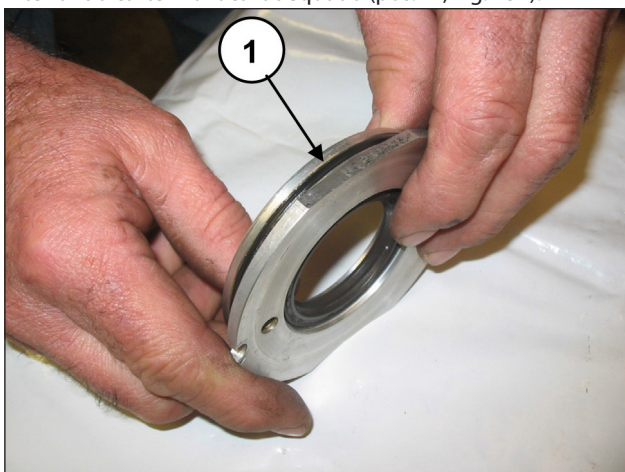

Fig. 130

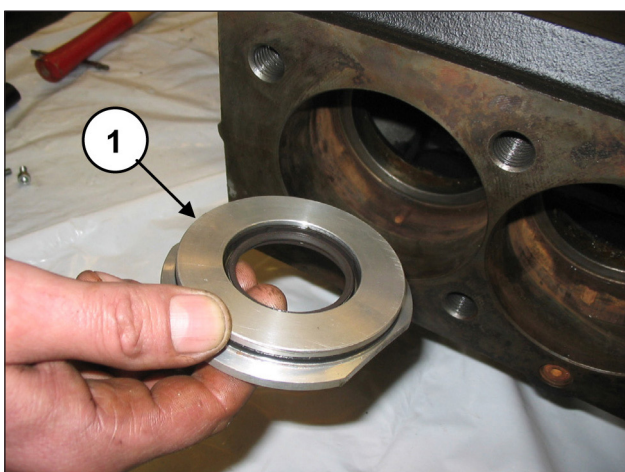

Fig. 131

Certifique-se de que a cobertura entre completamente no local (pos. ①, Fig. 132), prestando atenção para não danificar a borda da vedação do óleo. Aperte as coberturas da vedação do óleo através de dois parafusos M6x14 (pos. ①, Fig. 133).

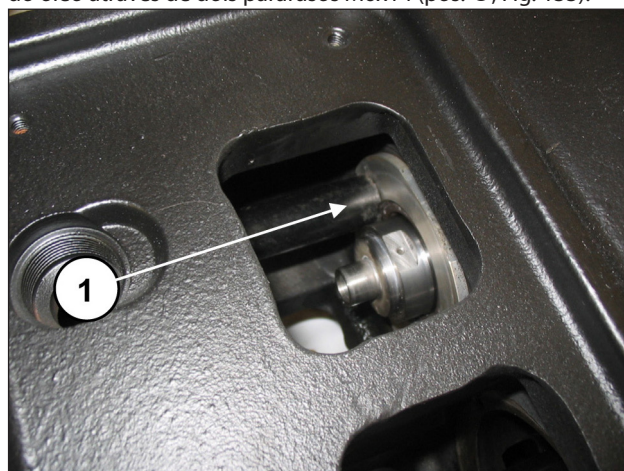

Fig. 132

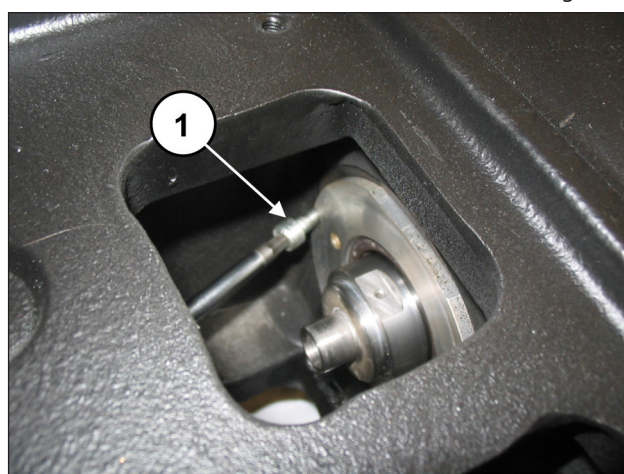

Fig. 133

Calibre os parafusos com chave dinamométrica, conforme indicado no capítulo 3.

Posicione a proteção contra respingos completa do anel circular no compartimento da guia do pistão (pos. ①, Fig. 134 e Fig. 135).

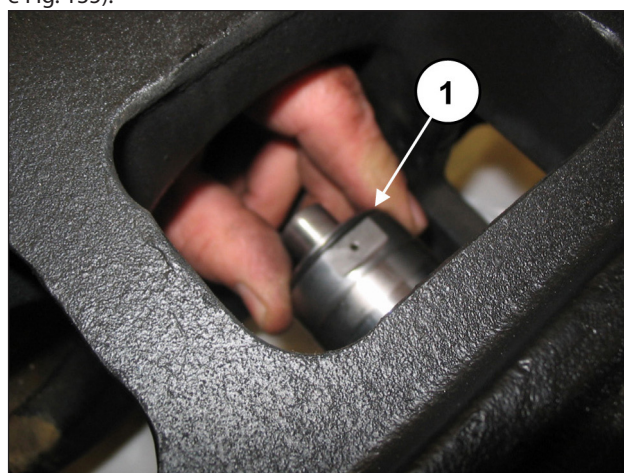

Fig. 134

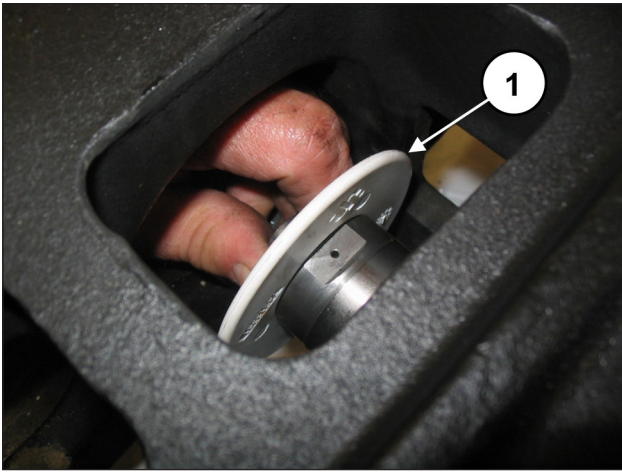

Fig. 135

Insira a arruela Ø10x18x0.9 no parafuso de fixação do pistão (pos. ①, Fig. 136).

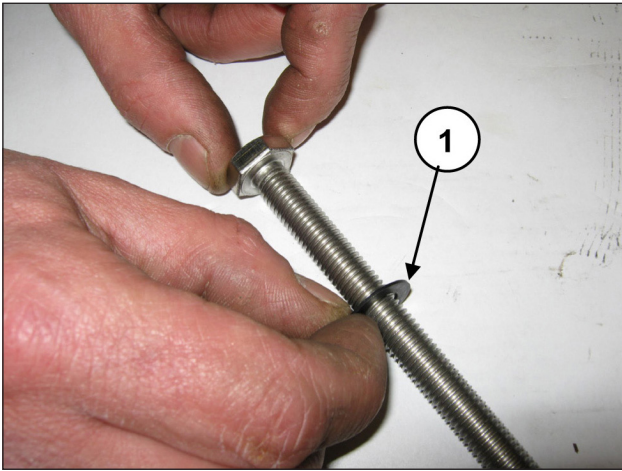

Fig. 136

Monte os pistões nas respectivas guias (pos. ①, Fig. 137) e fixe-as, conforme a pos. ①, Fig. 138.

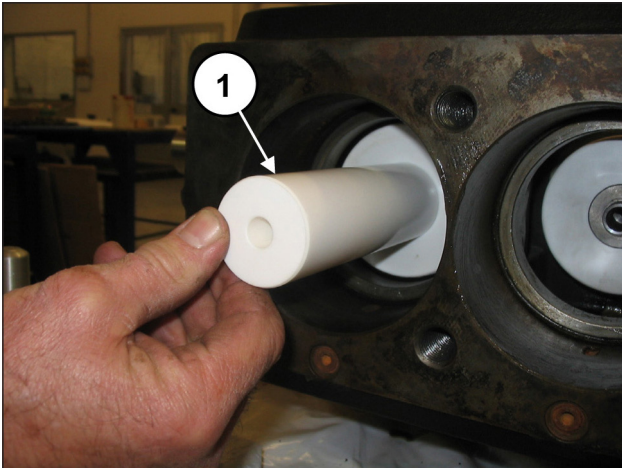

Fig. 137

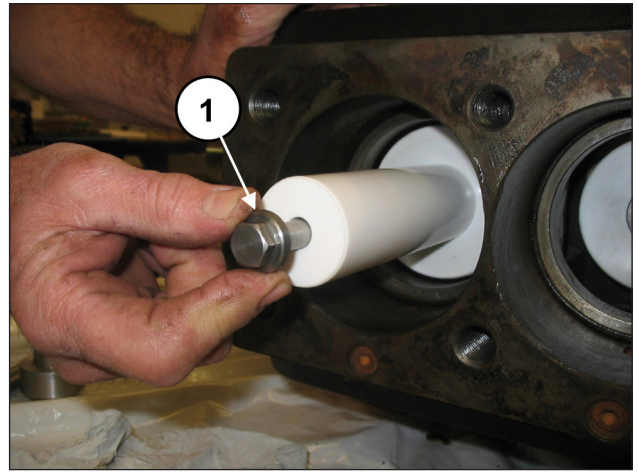

Fig. 138

Calibre os parafusos com chave dinamométrica, conforme indicado no capítulo 3.

Insira o anel circular no interior do carter da bomba (pos. ①, Fig. 139) e em seguida, o bloco da camisa - suporte do forro (completo pelo mesmo anel circular), anteriormente montado até a passagem (pos. ①, Fig. 140).

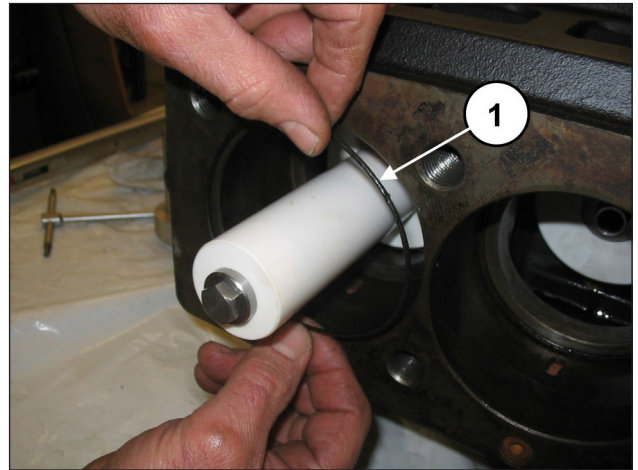

Fig. 139

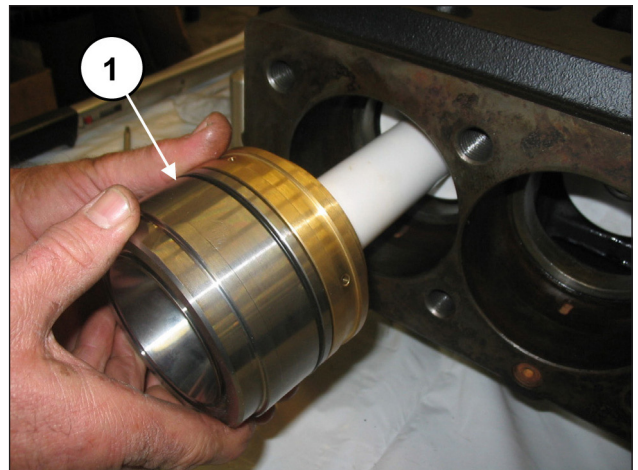

Fig. 140

Certifique-se de que o bloco da camisa - suporte chegue a se posicionar no fundo do local (pos. ①, Fig. 141).

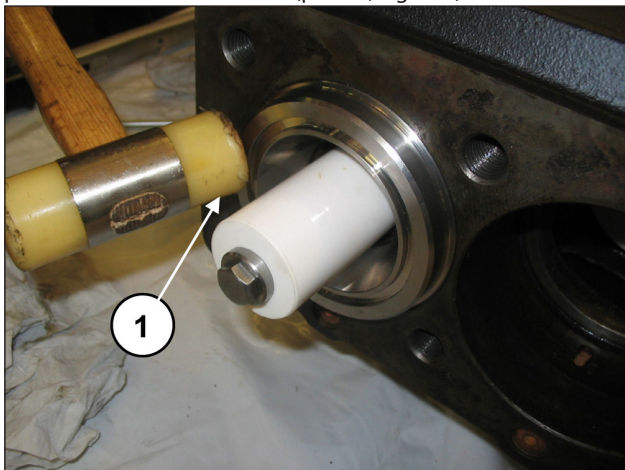

Fig. 141

Monte o anel circular frontal da camisa (pos. ①, Fig. 142) e o anel circular do furo de recirculação (pos. ①, Fig. 143).

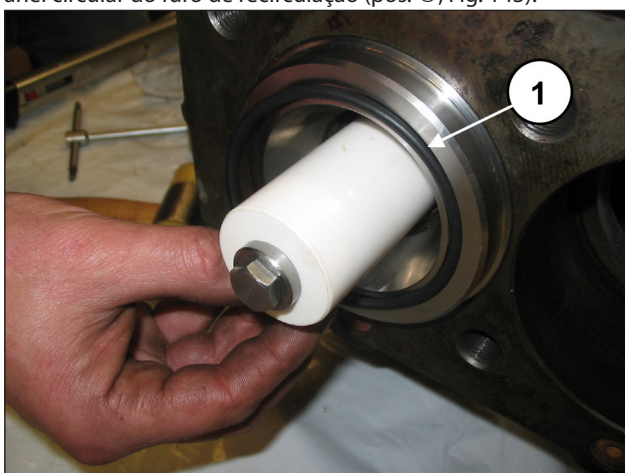

Fig. 142

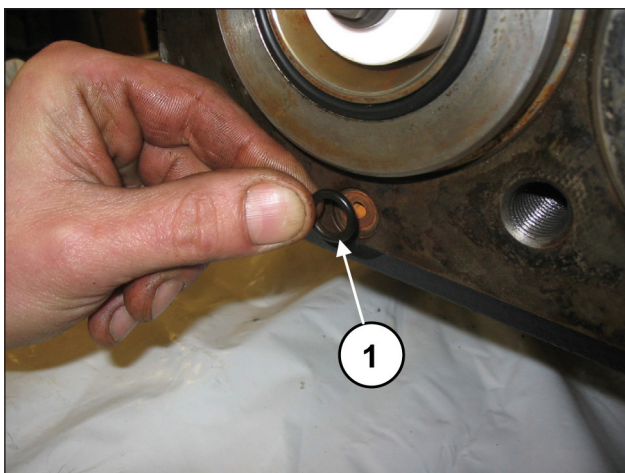

Fig. 143

Nas coberturas de inspeção, insira o anel circular (pos. ①, Fig. 144) e monte as coberturas mediante o uso de 4+4 parafusos M6x14 (pos. ①, Fig. 145).

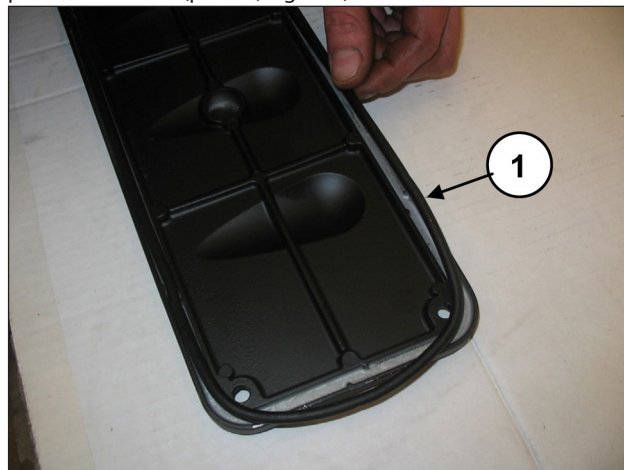

Fig. 144



Fig. 145

Calibre os parafusos com chave dinamométrica, conforme indicado no capítulo 3.

2.2.5 Recuperação dos cabeçotes

Se o cabeçote apresentar no interior das câmaras dos pistões sinais evidentes de cavitação, devido a uma alimentação incorreta da bomba, é possível recuperar o cabeçote danificado evitando a sua substituição.

Para a recuperação do cabeçote, realize os trabalhos indicados na Fig. 146, nas versões com pistão Ø 40-45-50 e indicados na Fig. 147, com pistão Ø 55-60-65:

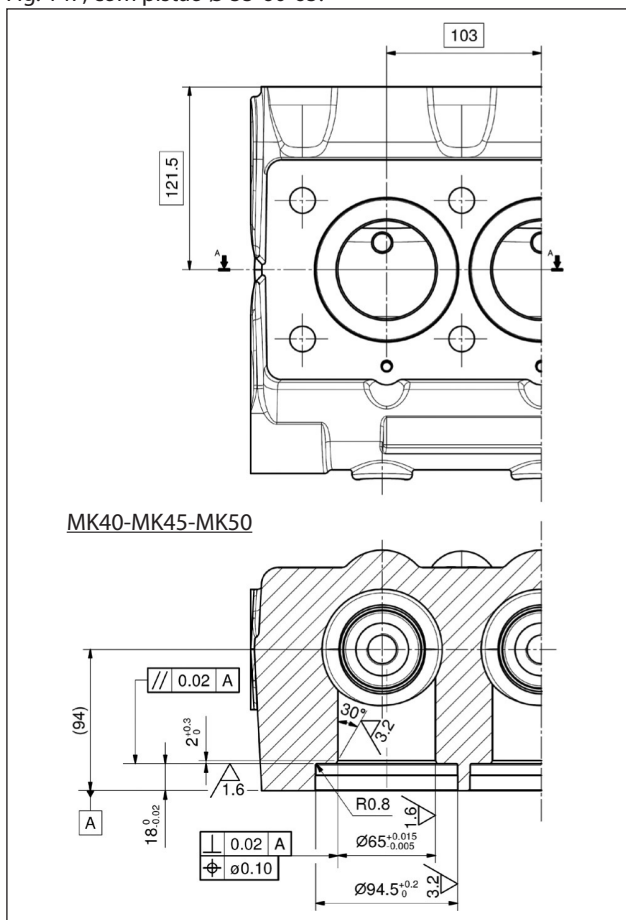

Fig. 146

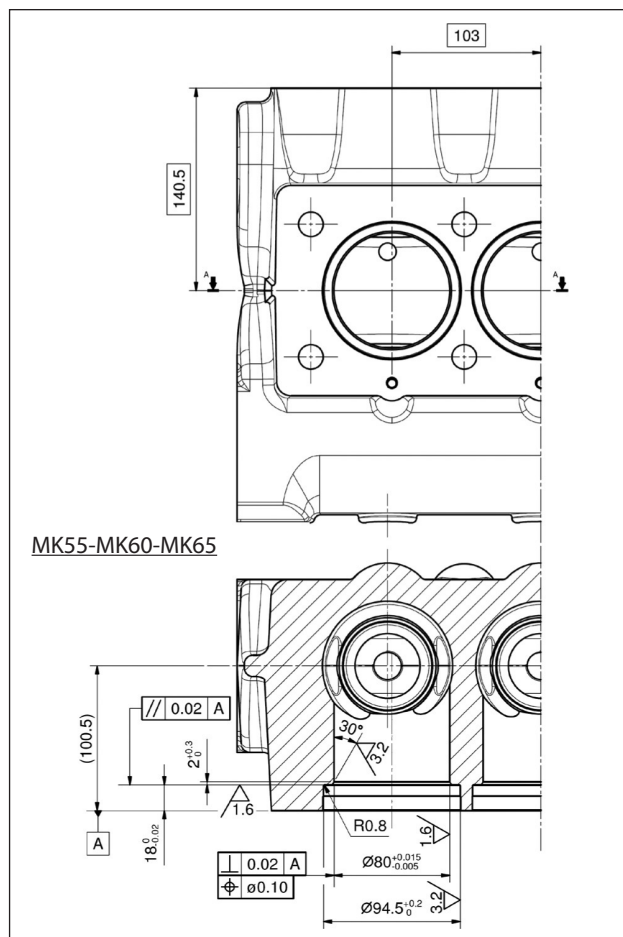

Fig. 147

O cabeçote trabalhado deve ser montado, ao martelar as buchas (pos. ①) completas com anéis anti-extrusão (pos. ②) e anel circular (pos. ③) conforme representado na Fig. 148, nas versões com pistão Ø40-45-50 e na Fig. 149, nas versões com pistão Ø 55-60-65:

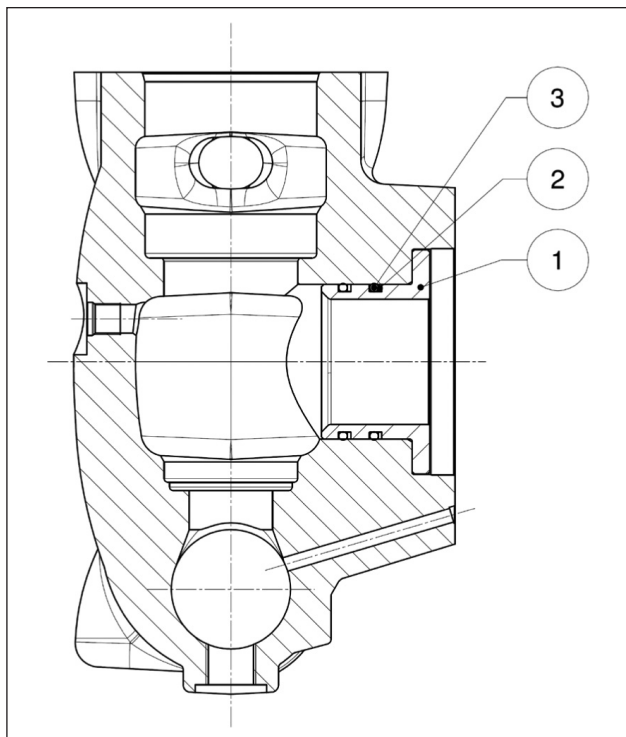

Fig. 148

- n. 1 - Bucha para versões com pistão Ø40-45-50 cód. 74215156 - quantidade 3
 n. 2 - Anel anti-extrusão - cód. 90526880 - quantidade 6
 n. 3 - anel circular - cód. 90410200 - quantidade

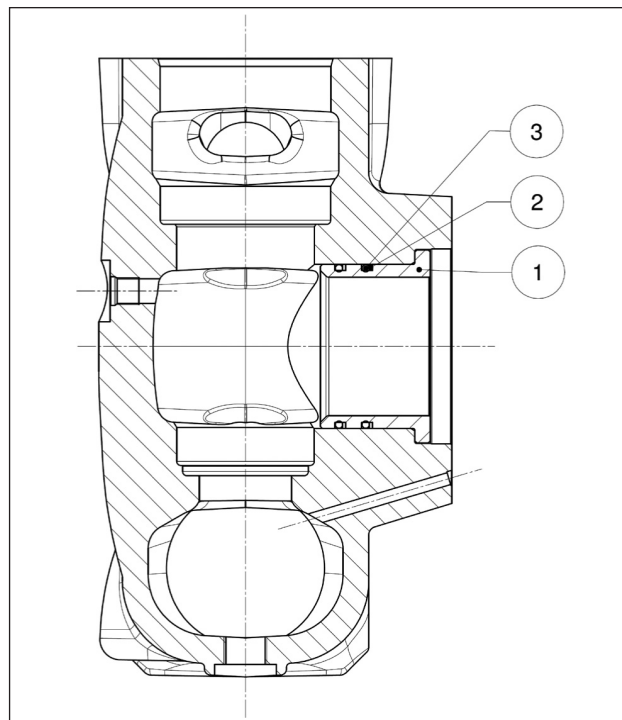

Fig. 149

- n. 1 - Bucha versões com pistão Ø55-60-65 cód.74215056 - qtde. 3
 n. 2 - Anel anti-extrusão - cód.90528500 - qtde. 6
 n. 3 - Anel circular - cód. 90412900 - quantidade 6

3 CALIBRAGEM DO APERTO DOS PARAFUSOS

O aperto dos parafusos é para ser executado exclusivamente com chave dinamométrica.

Descrição	Posição de explosão	Torque de aperto Nm
Parafuso M8x18 de cobertura do carter	54	20
Tampa G1/2x13 do carter	55	40
Parafuso M8x18 da flange do redutor	54	20
Parafuso M10x50 de cobertura do redutor	70	45
Parafuso M10x25 de fixação da coroa	65	45
Parafuso M12x40 da caixa do redutor	75	73.5
Parafuso M12x50 da caixa do redutor	64	73.5
Parafuso M6x14 das coberturas superior e inferior	41	10
Parafuso M12x30 da cobertura de rolamento	90	40
Parafuso M12x1.25x87 de aperto da haste	53	75*
Parafuso M6x20 da guia do pistão	49	10
Parafuso M6x14 de cobertura da vedação do óleo	41	10
Parafuso M10x160 de fixação do pistão	27	40
Parafuso M16x55 da cobertura da válvula	26	333
Tampa G1/4"x13 do cabeçote	13	40
Parafuso M16x180 do cabeçote	25	333**
Dispositivo de abertura da válvula	2	40

* Alcance o torque de aperto, apertando os parafusos simultaneamente

** Aperte os parafusos, começando pelos quatro parafusos internos, de modo transversal (ver Fig. 108), para depois prosseguir com os quatro parafusos externos, sempre apertando de modo transversal.

4 FERRAMENTAS PARA A REPARAÇÃO

A manutenção da bomba pode ser realizada através de ferramentas simples para a desmontagem e remontagem dos componentes. As seguintes ferramentas estão disponíveis:

Para a montagem:

Vedações do óleo da guia do pistão	cód. 27910900
Vedações do óleo do pinhão	cód. 27515900
	cód. 27548200
Anel circular do local da válvula do fluxo de versões com pistão Ø40-45-50	cód. 27516000
Anel circular do local da válvula do fluxo das versões com pistão Ø55-60-65	cód. 27516100

Para a desmontagem:

Local da válvula de aspiração versões com pistão Ø40-45-50	cód. 27516200
Local da válvula de aspiração versões com pistão Ø55-60-65	cód. 27516300
Local da válvula de fluxo	cód. 27516400
Cobertura da vedação do óleo	cód. 27516400
	cód. 27516500
Bloco da camisa + suporte das vedações	cód. 27516600
Cobertura do redutor	cód. 27516700
Eixo (bloqueio da haste)	cód. 27566200

5 SUBSTITUIÇÃO DA BUCHA DO PÉ DA HASTE

Realize a perfuração a frio da bucha e o processamento sucessivo, prestando atenção às dimensões e tolerâncias dos elementos subjacentes Fig. 150.

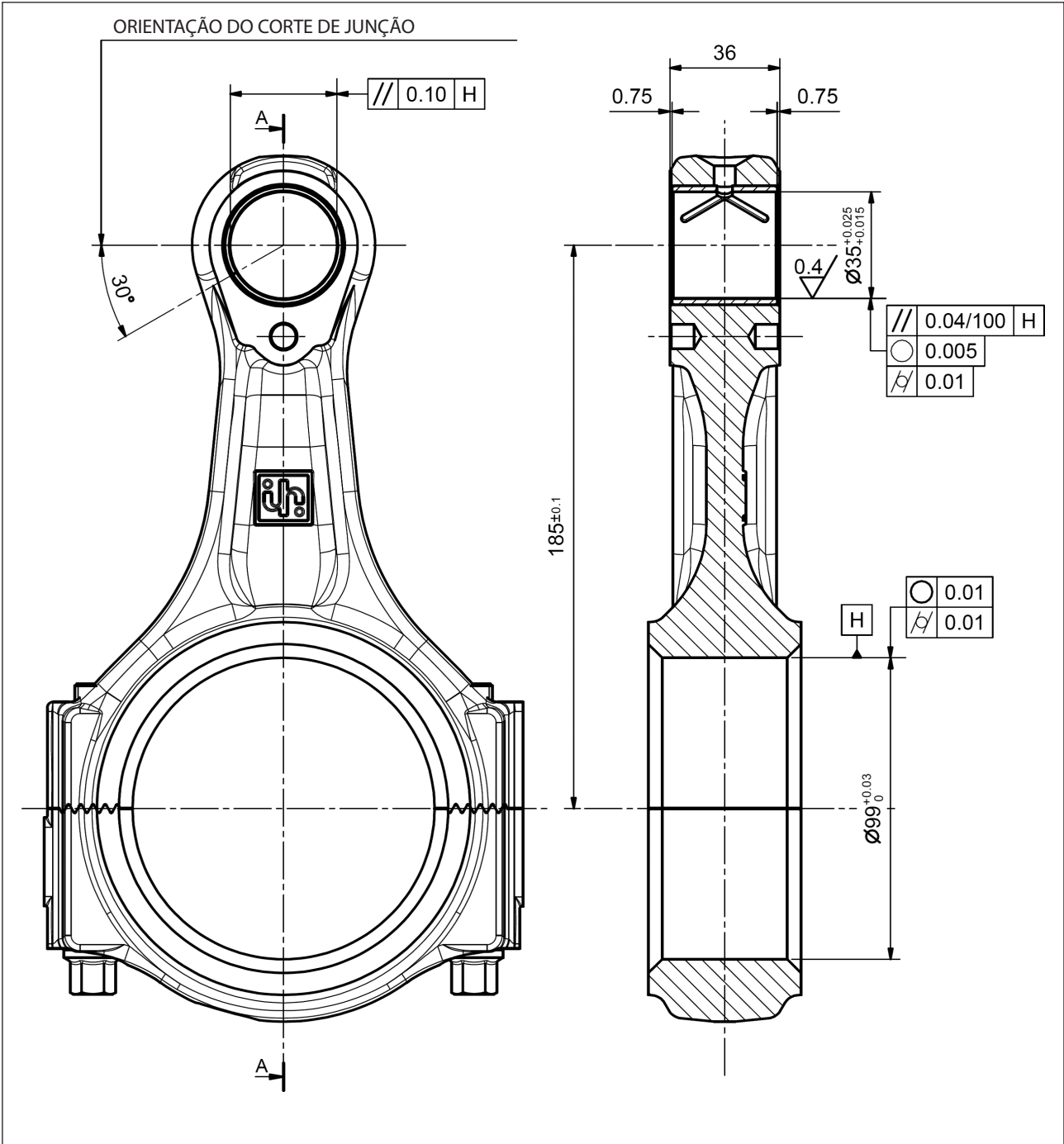

Fig. 150

6 VERSÕES ESPECIAIS

A seguir estão relacionadas as indicações relativas à reparação das versões especiais. Onde não diferentemente especificado, consulte o que foi relacionado anteriormente para a bomba MK-MKS versão padrão.

- Bombas MKC - MKSC: para a reparação, valem as indicações relativas à bomba MK-MKS versão padrão.
- Bombas MKR - MKSR: para a reparação, valem as indicações relativas à bomba MK padrão, excluídas os forros de pressão para os quais deve-se seguir os parágrafos seguintes.

6.1 DESMONTAGEM DO GRUPO DO PISTÃO - SUPORTES - VEDAÇÃO

O grupo do pistão precisa de uma verificação periódica conforme indicado na tabela de manutenção preventiva do **Manual de uso e manutenção**.

As intervenções são limitadas somente ao controle visual da eventual drenagem do furo, presente na cobertura inferior. Caso se apresente anomalias/oscilações no manômetro de fluxo ou de gotejamento do furo de drenagem, será necessário proceder com o controle e a eventual substituição do pacote de vedação.

Para a extração dos grupos de pistão, opere como a seguir: Para acessar o grupo do pistão, desaperte os parafusos M16x180 e desmonte o cabeçote.



Retire o cabeçote com a máxima atenção para evitar bater os pistões.

Providencie a desmontagem dos pistões, soltando os parafusos de fixação (pos. ①, Fig. 151).

Retire o pistão do suporte do forro e verifique se a superfície do mesmo não apresente arranhões, sinais de desgaste ou de cavitação.

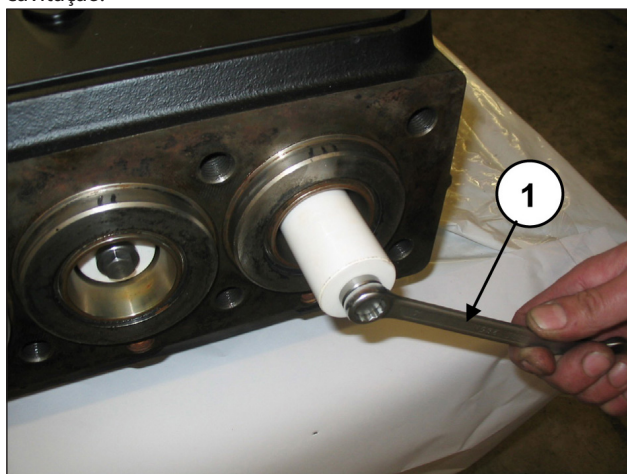

Fig. 151

Remova a cobertura de inspeção superior, soltando os quatro parafusos de fixação (pos. ①, Fig. 152).

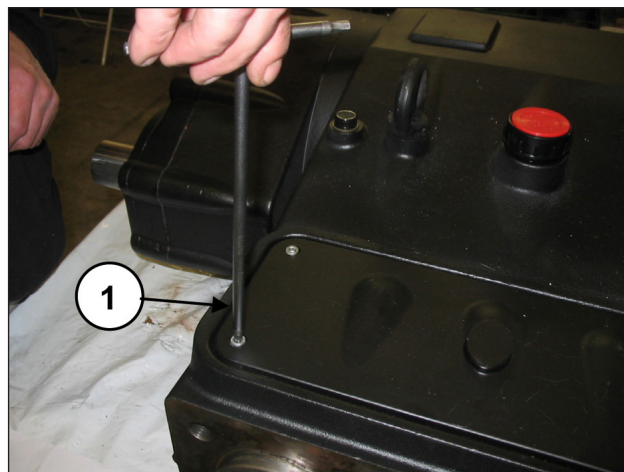

Fig. 152

Gire manualmente o eixo, de modo a trazer os três pistões progressivamente na posição de ponto morto superior e insira a ferramenta do tampão, cód. 27516600 entre a guia do pistão e o pistão (pos. ①, Fig. 153).

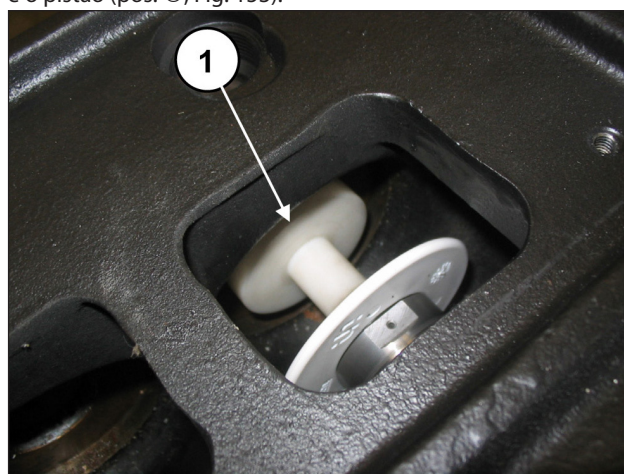

Fig. 153

Girando o eixo, faça avançar a guia do pistão de modo que a tampa, avançando à sua volta, podendo ejetar o suporte dos forros, a mola e todo o grupo do pistão (pos. ①, Fig. 154).

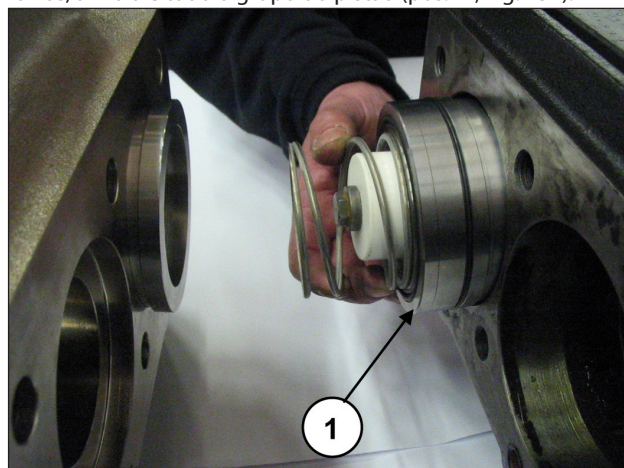

Fig. 154

Extraia o grupo de suporte das vedações e a ferramenta do tampão.

Remova o anel circular de fundo do suporte do forro, se não permanecer no interior do carter da bomba (pos. ①, Fig. 155).

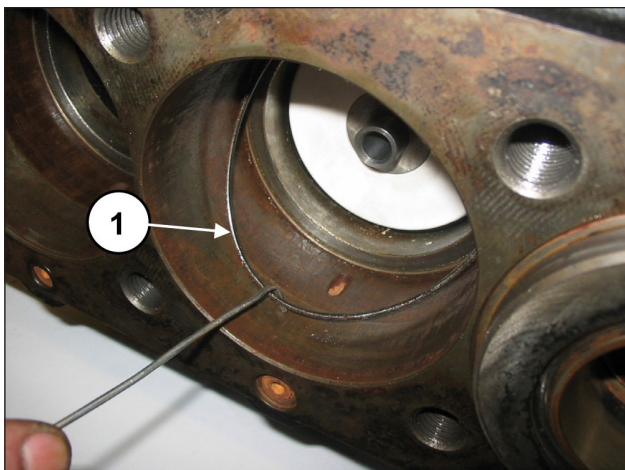

Fig. 155

Solte os anéis de proteção contra respingos da guia dos pistões (pos. ①, Fig. 156).

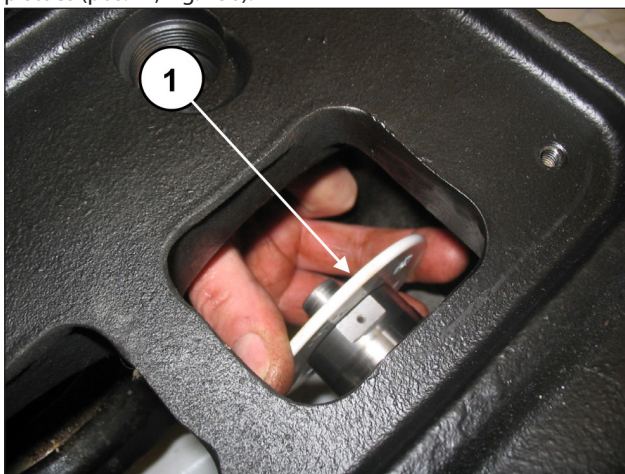

Fig. 156

Caso seja necessário substituir a vedação do óleo da guia do pistão, desmonte a cobertura da vedação do óleo, procedendo da seguinte forma:

Solte os dois parafusos de bloqueio da cobertura da vedação do óleo (pos. ①, Fig. 157).

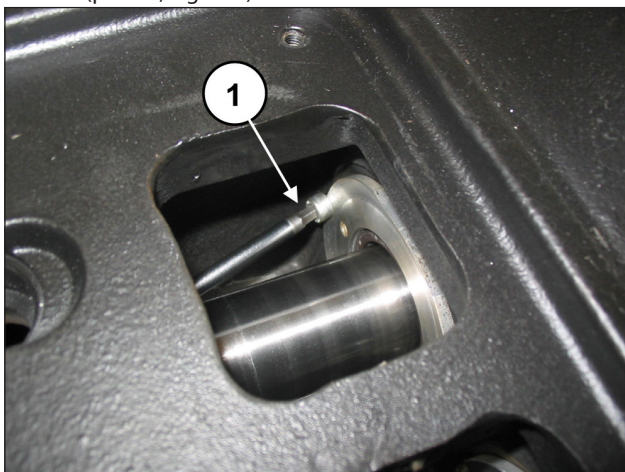

Fig. 157

Posicione a guia do pistão no ponto morto inferior, solte o extrator, cód. 27516400, incluindo o adaptador M5, cód. 27516500 nos furos adequados, colocados na cobertura (pos. ①, Fig. 158) e extraia a cobertura da vedação do óleo do grupo da bomba (pos. ①, Fig. 159).

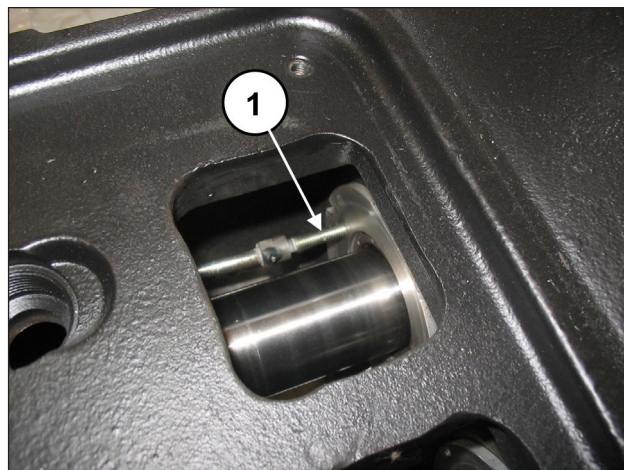

Fig. 158



Fig. 159

Substitua a vedação do óleo (pos. ①, Fig. 160) e o anel circular externo (pos. ②, Fig. 160).

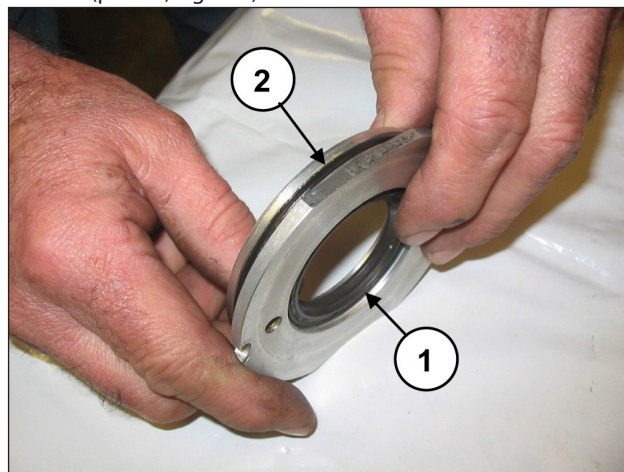

Fig. 160

Separe o suporte de vedação da camisa, retire o anel para a mola e o anel raspador (pos. ①②, Fig. 161) para acessar as vedações de pressão (pos. ①, Fig. 162).

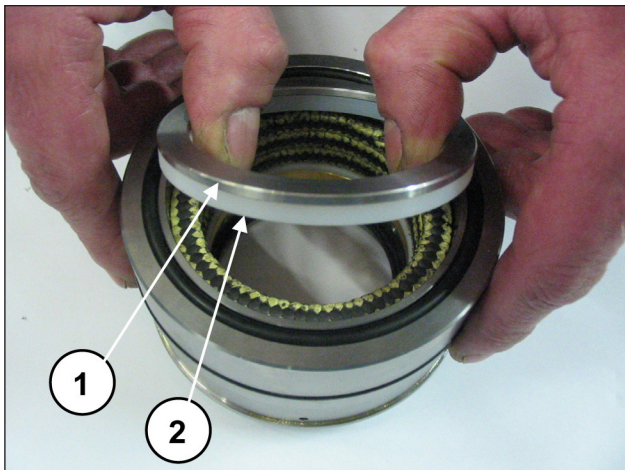

Fig. 161

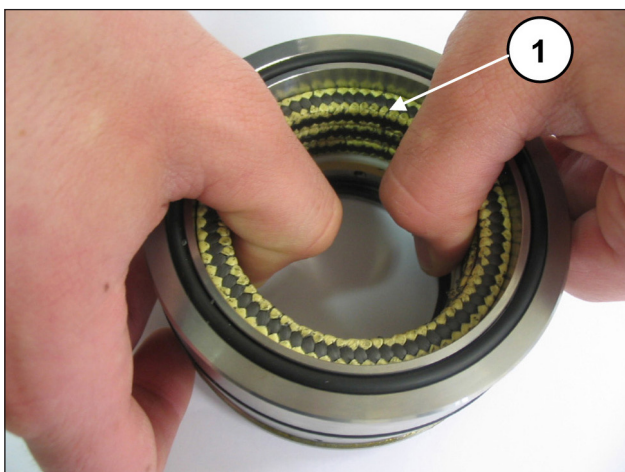

Fig. 162

Para remover o forro de baixa pressão, é necessário usar um medidor de espessura ou uma ferramenta que não danifique o local do suporte do forro (pos. ①, Fig. 163).



Fig. 163

6.2 MONTAGEM DO GRUPO DO PISTÃO - SUPORTES - VEDAÇÃO

Proceda com a remontagem, seguindo o procedimento inverso da remontagem indicada no parág. 6.1.



Substitua as vedações de pressão, umedecendo as bordas com lubrificante de silicone (sem borrfar), prestando muita atenção para não danificá-las durante a inserção na camisa.



A cada desmontagem, os forros de pressão devem ser sempre substituídas juntas com todos os anéis circulares.

Insira o forro de baixa pressão no suporte da embalagem (pos. ①, Fig. 164), prestando atenção ao sentido de montagem que fornece a borda de vedação para frente (em direção ao cabeçote) e o anel circular (pos. ②, Fig. 164).

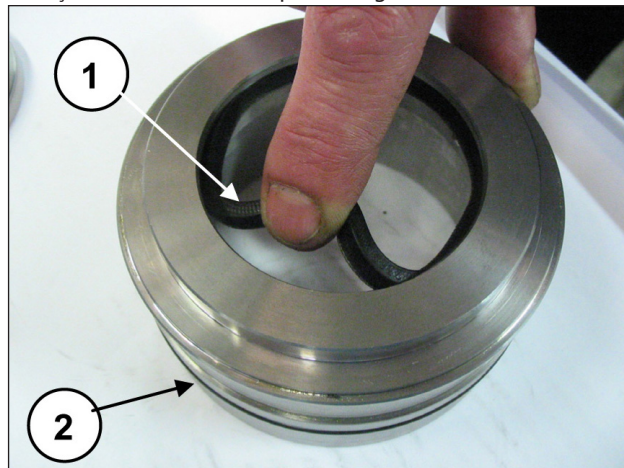

Fig. 164

Monte o anel de suporte e o anel de anti-extrusão (pos. ①②, Fig. 165), e as três embalagens, prestando atenção para que os entalhes estejam localizados a 120° de um para outro (pos. ①, Fig. 166), o anel raspador da embalagem e o anel para mola (pos. ①②, Fig. 167).

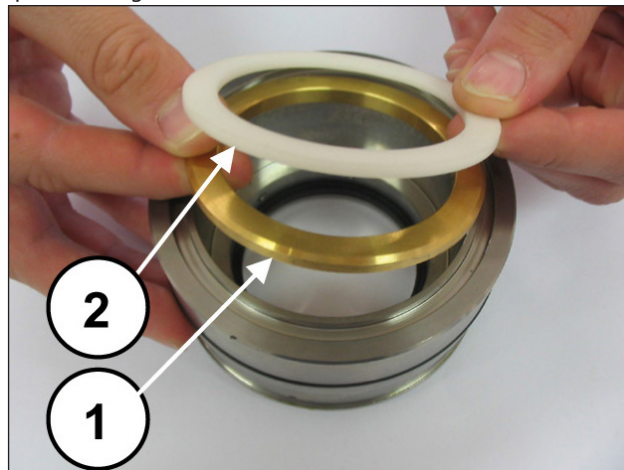

Fig. 165

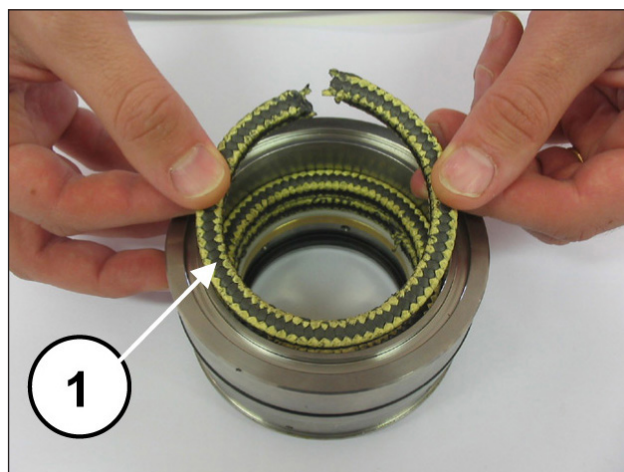

Fig. 166

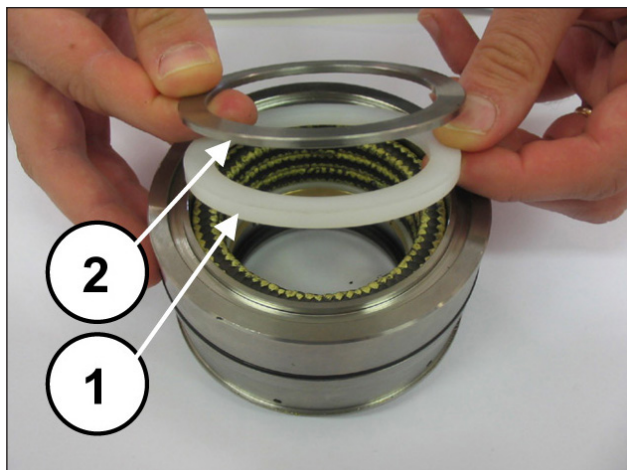

Fig. 167

Monte agora sobre o anel do cabeçote do anel circular (pos. ①, Fig. 168) e posicione-o no local sobre o cabeçote.

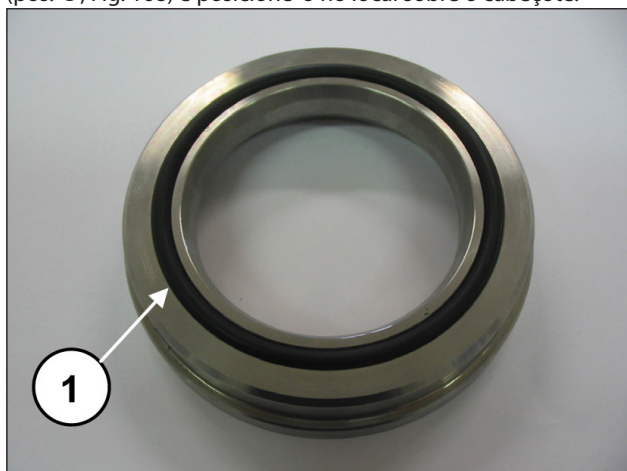

Fig. 168

Monte a vedação do óleo na cobertura da mesma (pos. ①, Fig. 169), mediante o uso de uma tampa, cód. 27910900.

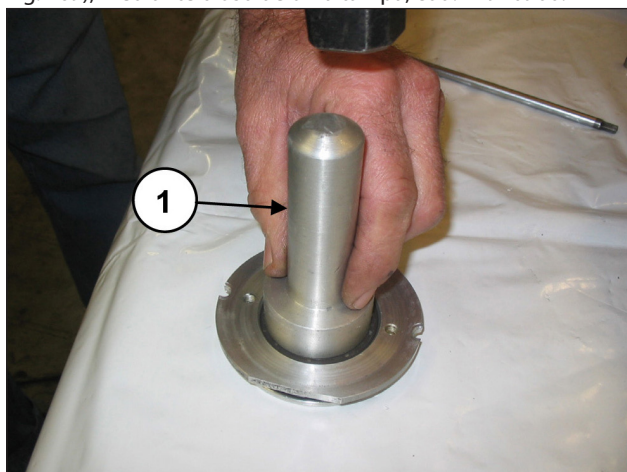

Fig. 169

Posicione o anel circular (pos. ①, Fig. 170) no local da cobertura da vedação do óleo e insira o grupo montado no interior do carter no local adequado (pos. ①, Fig. 171).

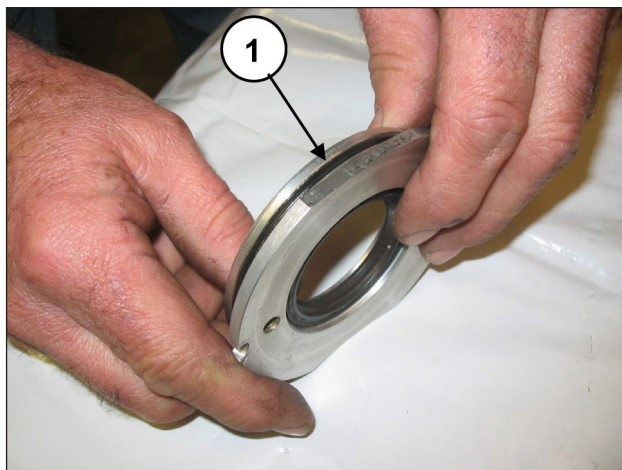

Fig. 170

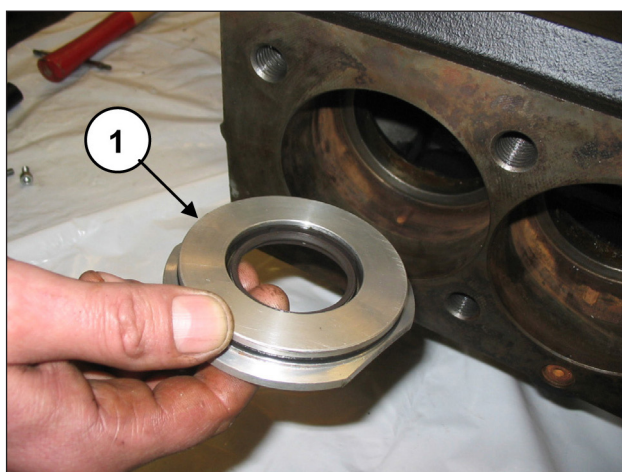

Fig. 171

Certifique-se de que a cobertura entre completamente no local (pos. ①, Fig. 172), prestando atenção para não danificar a borda da vedação do óleo. Aperte as coberturas da vedação do óleo através de dois parafusos M6x14 (pos. ①, Fig. 173).

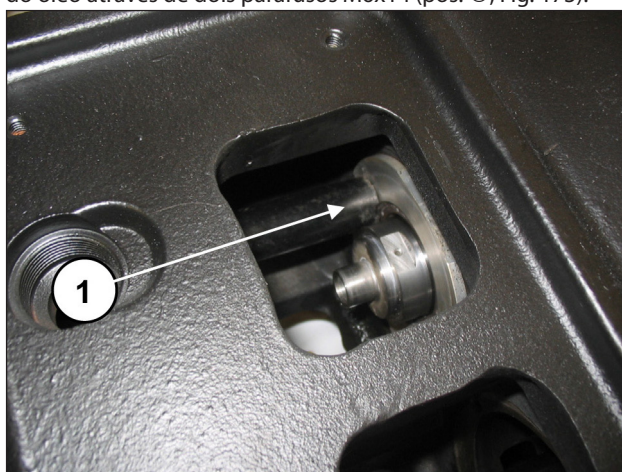

Fig. 172

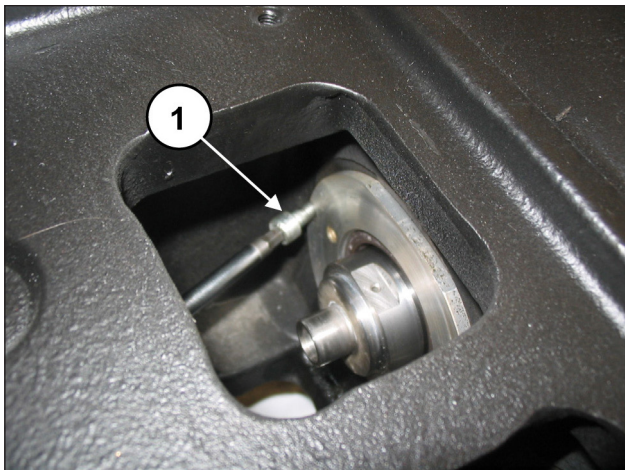

Fig. 173

Calibre os parafusos com chave dinamométrica, conforme indicado no capítulo 3.
 Posicione a proteção contra respingos completa do anel circular no compartimento da guia do pistão (pos. ①, Fig. 174 e Fig. 175).

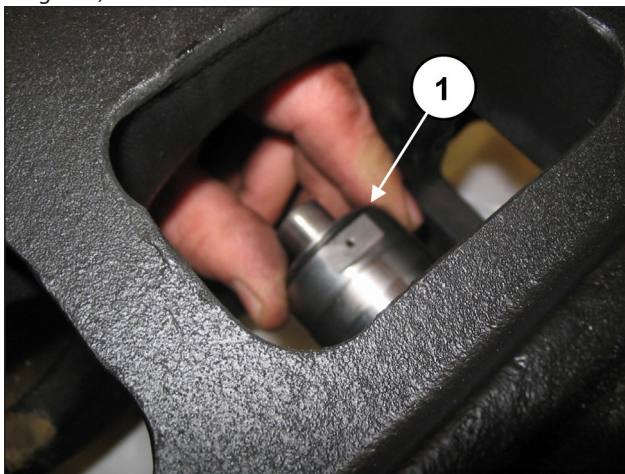

Fig. 174

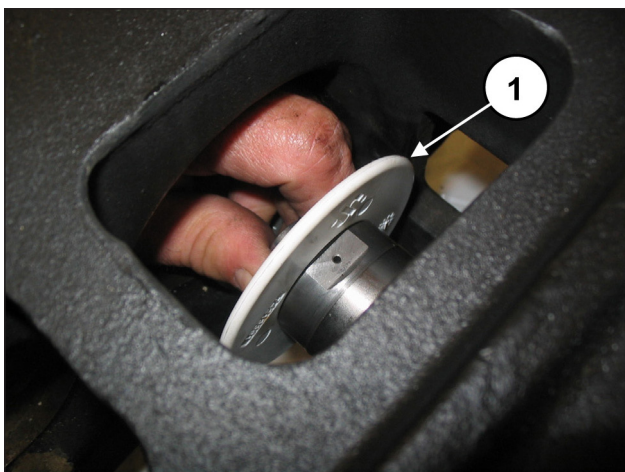

Fig. 175

Insira a arruela Ø10x18x0.9 no parafuso de fixação do pistão (pos. ①, Fig. 176).

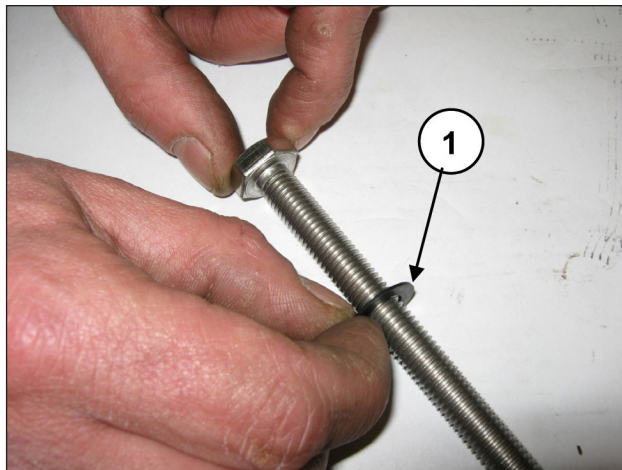

Fig. 176

Monte os pistões nas respectivas guias (pos. ①, Fig. 177) e fixe-as, conforme a pos. ①, Fig. 178.

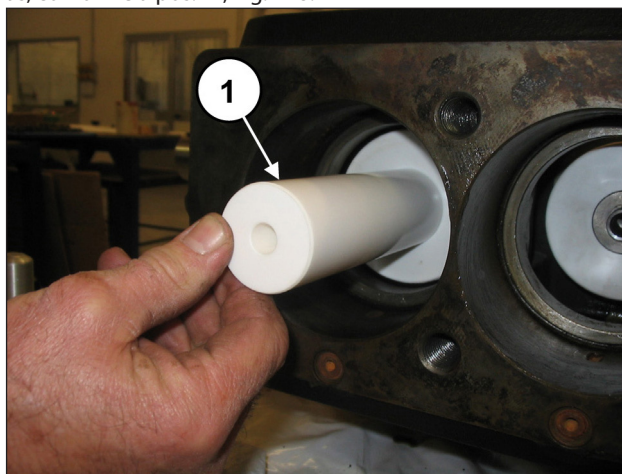

Fig. 177

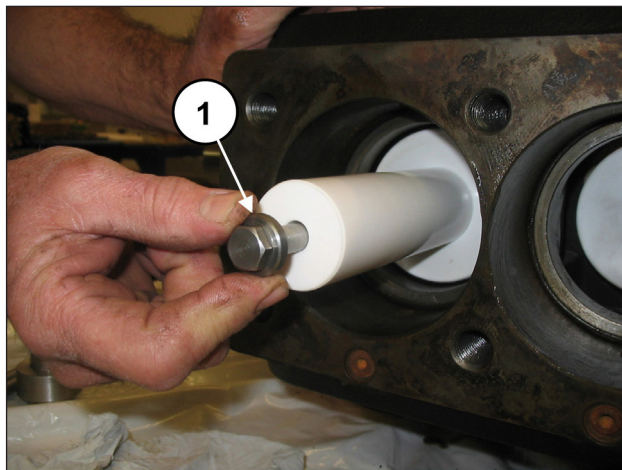

Fig. 178

Calibre os parafusos com chave dinamométrica, conforme indicado no capítulo 3.
 Insira o anel circular no interior do carter da bomba (pos. ①, Fig. 179) e em seguida, o bloco da camisa - suporte do ferro (completo pelo mesmo anel circular), anteriormente montado até a passagem (pos. ①, Fig. 180).

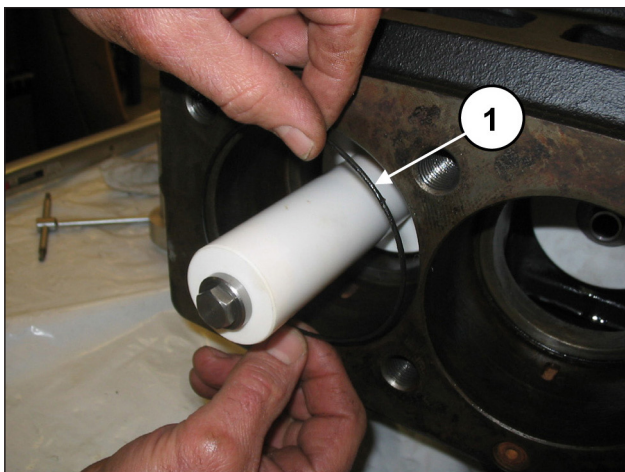

Fig. 179

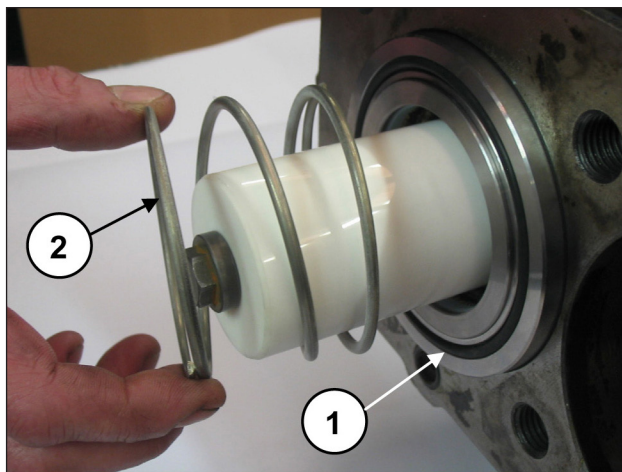

Fig. 182

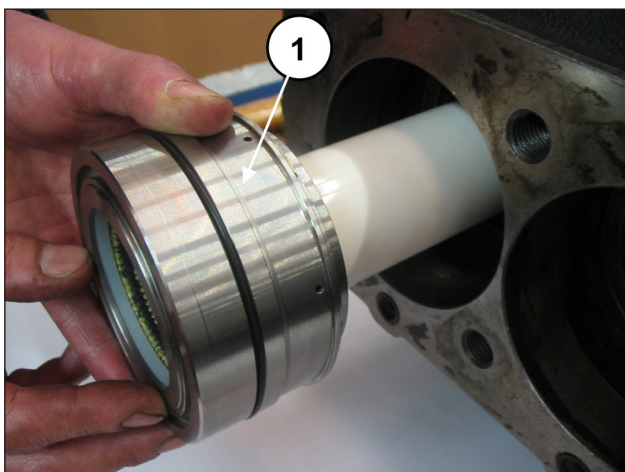

Fig. 180

Certifique-se de que o bloco da camisa - suporte chegue a se posicionar no fundo do local (pos. ①, Fig. 181); monte agora o anel circular frontal da camisa e da mola (pos. ①②, Fig. 182).

Monte o anel circular do furo de recirculação (pos. ①, Fig. 183). **Facilite a manutenção no local do anel circular com leve aplicação de lubrificante.**
A Fig. 184 mostra a montagem subsequente do cabeçote.



Fig. 183

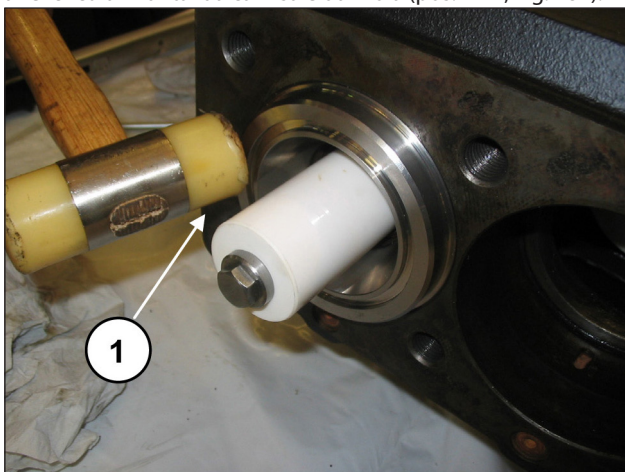

Fig. 181

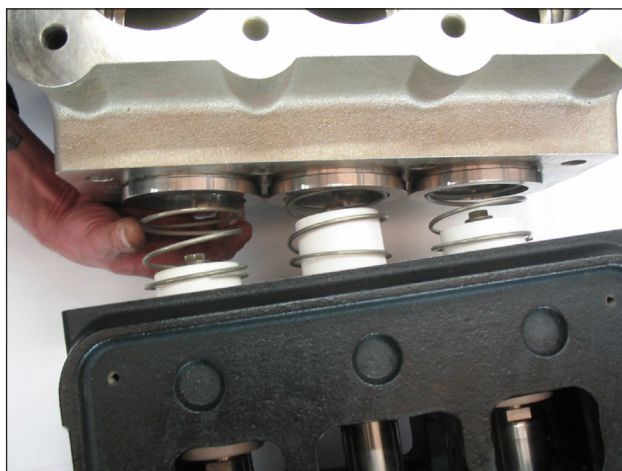

Fig. 184

Nas coberturas de inspeção, insira o anel circular (pos. ①, Fig. 185) e monte as coberturas mediante o uso de 4+4 parafusos M6x14 (pos. ①, Fig. 186).

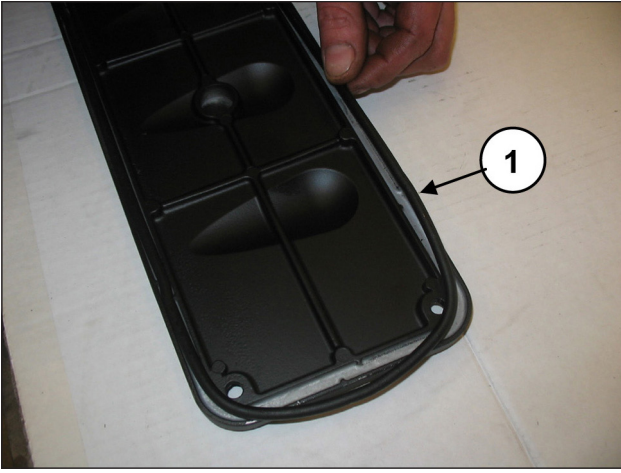

Fig. 185

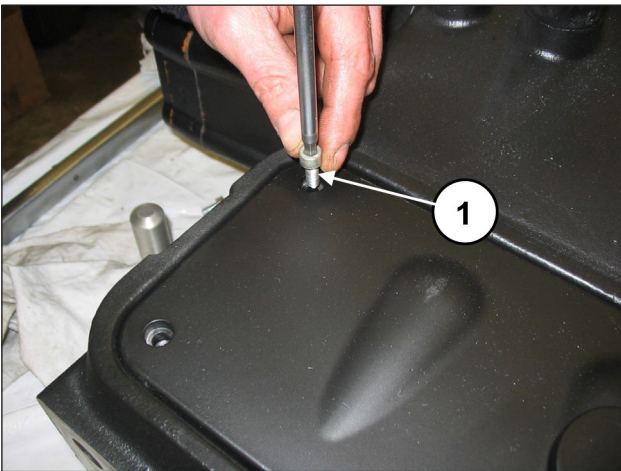
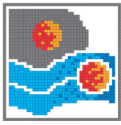

Fig. 186

Calibre os parafusos com chave dinamométrica, conforme indicado no capítulo 3.



Pratissoli

Copyright di queste istruzioni operative è di proprietà di Interpump Group.

Le istruzioni contengono descrizioni tecniche ed illustrazioni che non possono essere elettronicamente copiate e neppure riprodotte interamente od in parte né passate a terzi in qualsiasi forma e comunque senza l'autorizzazione scritta dalla proprietà. I trasgressori saranno perseguiti a norma di legge con azioni appropriate.

Copyright of these operating instructions is property of Interpump Group.

The instructions contain technical descriptions and illustrations which may not be entirely or in part copied or reproduced electronically or passed to third parties in any form and in any case without written permission from the owner. Violators will be prosecuted according to law with appropriate legal action.

D'après les lois de Copyright, ces instructions d'utilisation appartiennent à Interpump Group.

Les instructions contiennent des descriptions techniques et des illustrations qui ne peuvent être ni copiées ni reproduites par procédé électronique, dans leur intégralité ou en partie, ni confiées à des tiers sous quelque forme que ce soit, en l'absence de l'autorisation écrite du propriétaire. Les transgresseurs seront poursuivis et punis par la loi.

Copyright-Inhaber dieser Betriebsanleitung ist Interpump Group.

Die Anleitung enthält technische Beschreibungen und Abbildungen, die nur mit vorheriger schriftlicher Genehmigung des Copyright-Inhabers elektronisch kopiert, zur Gänze oder teilweise reproduziert oder in jeglicher Form an Dritte weitergegeben werden dürfen. Bei Verstößen drohen Rechtsfolgen.

El copyright de estas instrucciones operativas es propiedad de Interpump Group.

Las instrucciones contienen descripciones técnicas e ilustraciones que no pueden ser copiadas electrónicamente ni reproducidas de modo parcial o total, así como pasadas a terceras partes de cualquier forma y sin la autorización por escrito de la propiedad. Los infractores serán procesados de acuerdo a la ley con las medidas adecuadas.

Os direitos autorais destas instruções operacionais são de propriedade da Interpump Group.

As instruções contêm descrições técnicas e ilustrações que não podem ser eletronicamente copiadas ou reproduzidas inteiramente ou em parte, nem repassar a terceiros de qualquer forma sem autorização por escrito da proprietária. Os infratores serão processados de acordo com a lei, com as ações apropriadas.

I dati contenuti nel presente documento possono subire variazioni senza preavviso.

The data contained in this document may change without notice.

Les données contenues dans le présent document peuvent subir des variations sans préavis.

Änderungen an den in vorliegendem Dokument enthaltenen Daten ohne Vorankündigung vorbehalten.

Los datos contenidos en el presente documento pueden sufrir variaciones sin previo aviso.

Os dados contidos no presente documento podem estar sujeitos a alterações, sem aviso prévio.



Pratissoli

A brand of INTERPUMP GROUP S.p.A.

42049 S. Ilario—Reggio Emilia (Italy)

Tel. +39-0522-904311

Fax +39-0522-904444

E-mail : info@pratissolipompe.com

<http://www.pratissolipompe.com>



INTERPUMP GROUP

**AZIENDA CON SISTEMA
DI GESTIONE QUALITÀ
CERTIFICATO DA DNV
= ISO 9001 =**